

# PHILIPS

## Screeneo U5

Digital Projector

SCN550

# Quick Start Guide



Download the **full user manual** at:  
[www.philips.com/support](http://www.philips.com/support) and register  
your product for further support.

# Screeneo U5

Thank you for choosing our Digital Projector.  
We carefully engineered and crafted this product for you  
to enjoy TV shows, devour your favorite movies, laugh, cry,  
and share your best moments with your loved ones.

If you are happy, we are happy!  
Share your best moments on:



#philipsprojection

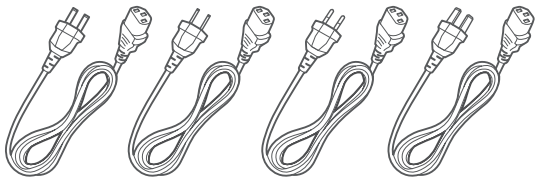
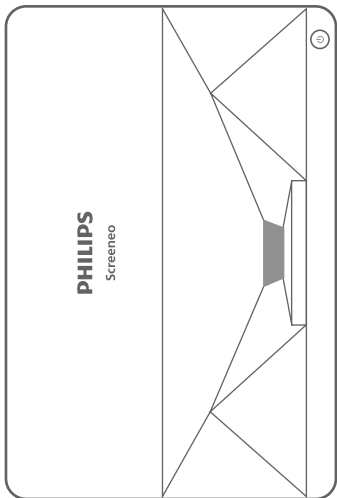



Wall

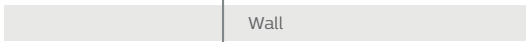

Wall

305cm  
120"



28cm  
0.9ft



20cm  
0.65ft



254cm  
100"

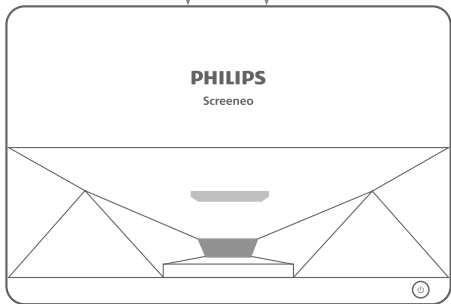



Keystone

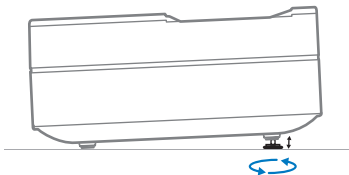
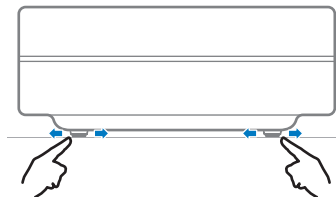
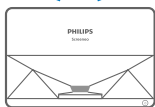
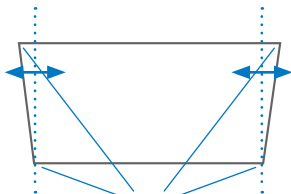



Power On/Off



OK Google

Direction Keys

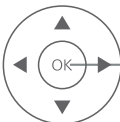

Ok Enter/Confirm

Back/Exit  
Home



Settings



Focus

Volume -



Mute

Volume +

**PHILIPS**

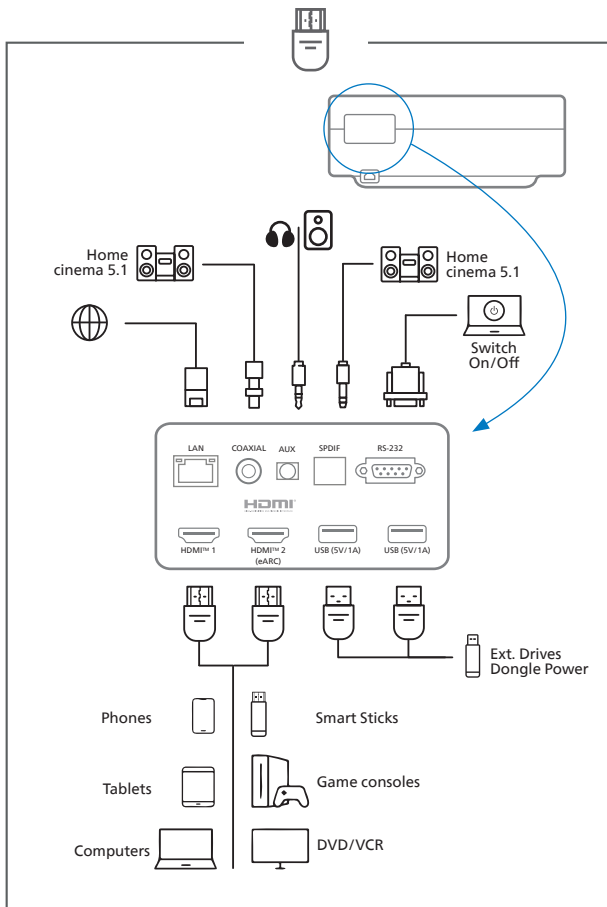

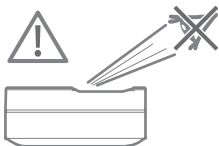

1

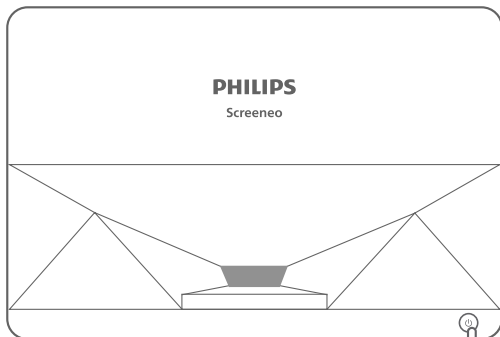

2



2 sec: Power On/Off  
1 sec: Standby







## Easy Set Up

### Set up your projector with an Android phone or tablet?

You can easily transfer account and network details from a compatible Android device with a few simple clicks.

Yes

Skip

Press  and  key simultaneously, while pointing to the projector within the distance of 1 meter at least 3 seconds. Release your finger when the indicator (red) of the remote flashes.

Skip this step if your remote doesn't have the button 



Skip

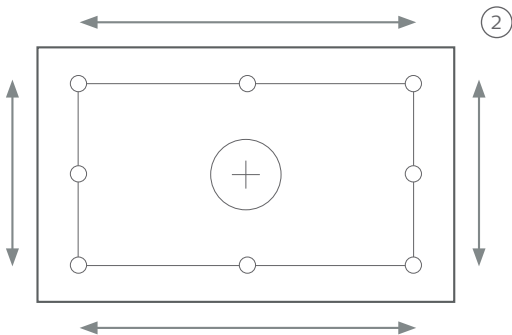
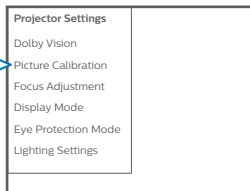



## Focus Adjustment



1 sec



Or



### Projector Settings

- Dolby Vision
- Picture Calibration
- Focus Adjustment
- Display Mode
- Eye Protection Mode
- Lighting Settings





## Eye Protection Mode On

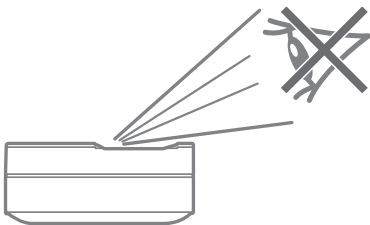
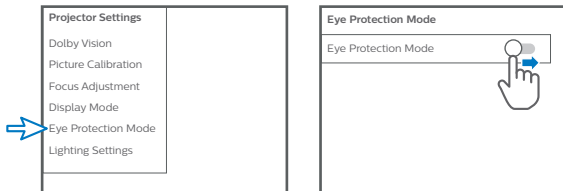

**SOFTWARE END USER LICENSE AGREEMENT****SOFTWARE-ENDBENUTZER-LIZENZVEREINBARUNG****CONTRAT DE LICENCE UTILISATEUR FINAL DE LOGICIEL****CONTRATTO DI LICENZA PER L'UTENTE FINALE DEL SOFTWARE (EULA)****SOFTWARELICENTIEOVEREENKOMST VOOR EINDGEBRUIKERS****CONTRATO DE LICENCIA DE USO DE SOFTWARE PARA USUARIO FINAL****ACORDO DE LICENÇA DO UTILIZADOR FINAL DO SOFTWARE****LICENSATALE FOR SLUTBRUGERE AF SOFTWARE****AVTALE OM SLUTTBRUKERLISENS FOR PROGRAMVARE****SLUTANVÄNDARAVTAL****OHJELMISTO- JA KÄYTTÖOIKEUSSOPIMUS****SZOFTVER VÉGFELHASZNÁLÓI SZERZŐDÉS****UMOWA LICENCYJNA UŻYTKOWNIKA KOŃCOWEGO OPROGRAMOWANIA****LICENČNÍ SMLOUVA S KONCOVÝM UŽIVATELEM NA SOFTWARE****ACORD DE LICENȚĂ FINAL UTILIZATOR SOFTWARE****YAZILIM SON KULLANICI LİSANS SÖZLEŞMESİ****ЛИЦЕНЗИОННОЕ СОГЛАШЕНИЕ С КОНЕЧНЫМ ПОЛЬЗОВАТЕЛЕМ ПРОГРАММНОГО ОБЕСПЕЧЕНИЯ****ΣΥΜΦΩΝΙΑ ΑΔΕΙΑΣ ΤΕΛΙΚΟΥ ΧΡΗΣΤΗ ΛΟΓΙΣΜΙΚΟΥ****소프트웨어 최종 사용자 사용권 계약서****软件最终用户许可协议**

This software end user license agreement ("this agreement") is a legal and binding agreement between you (either an individual or entity) and SCRENEO INNOVATION SA, a Swiss company, with its principal office at Route de Lully 5c, 1131 Tolochenaz, Switzerland. This agreement gives you the right to use certain software (the "software") including user documentation in electronic form which may have been provided separately or together with a SCRENEO INNOVATION SA (Philips branded) product (the "device") or a PC. By downloading, installing, or otherwise using the software, you accept and agree to be bound by all of the terms and conditions of this agreement. If you do not agree to these terms and conditions, do not download, install, or otherwise use the software. If you acquire the software in tangible media e.g., cd without the opportunity to review this license and do not accept these terms, you may receive a full refund of the amount, if any, that you paid for the software if you return the software unused with proof of payment within 30 days from the date of purchase.

**1. Grant of License.** This Agreement grants you a non-exclusive, non-transferable, non-sub licensable license to install and use, on the Device or a PC, as applicable, one (1) copy of the specified version of the Software in object code format as set out in the user documentation solely for your personal use. The Software is "in use" when it is loaded into the temporary or permanent memory (i.e. RAM, hard disk, etc.) of the PC or the Device.

**2. Ownership.** The Software is licensed and not sold to you. This Agreement grants you only the right to use the Software, but you do not acquire any rights, express or implied, in the Software other than those specified in this Agreement. SCRENEO INNOVATION SA and its licensors retain all right, title, and interest in and to the Software, including all patents, copyrights, trade secrets, and other intellectual property rights incorporated therein. The Software is protected by copyright laws, international treaty provisions, and other intellectual property laws. Therefore, other than as expressly set forth herein, you may not copy the Software without prior written authorization of SCRENEO INNOVATION SA, except that you may make one (1) copy of the Software for your back-up purposes only. You may not copy any printed materials accompanying the Software, nor print more than one (1) copy of any user documentation provided in electronic

form, except that you may make one (1) copy of such printed materials for your back-up purposes only.

**3. License Restrictions.** Except as provided otherwise herein, you shall not rent, lease, sublicense, sell, assign, loan, or otherwise transfer the Software. You shall not, and you shall not permit any third party, to reverse engineer, decompile, or disassemble the Software, except to the extent that applicable law expressly prohibits the foregoing restriction. You may not remove or destroy any product identification, copyright notices, or other proprietary markings or restrictions from the Software. All titles, trademarks, and copyright and restricted rights notices shall be reproduced on your back up copy of the Software. You may not modify or adapt the Software, merge the Software into another program or create derivative works based upon the Software.

**4. Termination of certain functionality.** The Software may contain components of certain licensed software including software licensed from Microsoft Corporation ("Microsoft") which implements Microsoft's digital rights management technology for Windows Media. Content providers are using the digital rights management technology for Windows Media ("WM-DRM") to protect the integrity of their content ("Secure Content") so that their intellectual property, including copyright, in such content is not misappropriated. Your Device may also use WM-DRM software to transfer or play Secure Content ("WM-DRM Software"). If the security of such WM-DRM Software is compromised, Microsoft may revoke (either on its own or upon the request of the owners of Secure Content ("Secure Content Owners")) the WM-DRM Software's right to acquire new licenses to copy, store, transfer, display and/or play Secure Content. Revocation does not alter the WM-DRM Software's ability to play unprotected content. A list of revoked WM-DRM Software is sent to your PC and/or your Device whenever you download a license for Secure Content. Microsoft may, in conjunction with such license, also download revocation lists onto your Device on behalf of Secure Content Owners, which may disable your Device's ability to copy, store, display,

transfer, and/or play Secure Content. Secure Content Owners may also require you to upgrade some of the WM-DRM components distributed with this Software ("WM-DRM Upgrades") before accessing their content. When you attempt to play Secure Content, WM-DRM Software built by Microsoft will notify you that a WM-DRM Upgrade is required and then ask for your consent before the WM-DRM Upgrade is downloaded. WM-DRM Software built by SCREENEO INNOVATION SA may do the same. If you decline the upgrade, you will not be able to access Secure Content that requires the WM-DRM Upgrade; however, you will still be able to access unprotected content and Secure Content that does not require the upgrade. WM-DRM features that access the Internet, such as acquiring new licenses and/or performing a required WM-DRM Upgrade, can be switched off. When these features are switched off, you will still be able to play Secure Content if you have a valid license for such content already stored on your Device. However, you will not be able to use certain of the WM-DRM Software features that require Internet access such as the ability to download content that requires the WM-DRM Upgrade. All title and intellectual property rights in and to the Secure Content is the property of the respective Secure Content owners and may be protected by applicable copyright or other intellectual property laws and treaties. This Agreement grants you no rights to use such Secure Content. To summarize, if the Software contains Microsoft WM-DRM components – Secure Content you desire to download, copy, store, display, transfer, and/or play is protected by the Microsoft WM-DRM components of the Software. Microsoft, Secure Content Owners, or Secure Content distributors may deny you access, or restrict your access, to Secure Content even after you have paid for, and/or obtained, it. Neither your consent nor the consent or approval of SCREENEO INNOVATION SA is necessary for any of them to deny, withhold or otherwise restrict your access to Secure Content. SCREENEO INNOVATION SA does not guaranty that you will be able to download, copy, store, display, transfer, and/or play Secure Content.

**5. Open Source Software.** (a) This software may contain components that are subject to open-source terms. This Agreement does not apply to this software as such. More information can be found in the documentation. If applicable, source code which needs to be offered under the applicable open source licenses will be delivered upon request, please contact [phillips.projector.eu@screeneo.com](mailto:phillips.projector.eu@screeneo.com) in English, with product identification or for more information. (b) Your license rights under this Agreement do not include any right or license to use, distribute or create derivative works of the Software in any manner that would subject the Software to Open Source Terms. "Open Source Terms" means the terms of any license that directly or indirectly (i) create, or purport to create, obligations for SCREENEO INNOVATION SA with respect to the Software and/or derivative works thereof; or (2) grant, or purport to grant, to any third party any rights or immunities under intellectual property or proprietary rights in the Software or derivative works thereof.

**6. Termination.** This Agreement shall be effective upon installation or first use of the Software and shall terminate (i) at the discretion of SCREENEO INNOVATION SA, due to your failure to comply with any term of this Agreement; or (ii) upon destruction of all copies of the Software and related materials provided to you by SCREENEO INNOVATION SA hereunder. SCREENEO INNOVATION SA's rights and your obligations shall survive the termination of this Agreement.

**7. Upgrades.** SCREENEO INNOVATION SA may, at its sole option, make upgrades to the Software available by general posting on a website or by any other means or methods. Such upgrades may be made available pursuant to the terms of this Agreement or the release of such upgrades to you may be subject to your acceptance of another agreement.

**8. Support Services.** SCREENEO INNOVATION SA is not obligated to provide technical or other support ("Support Services") for the Software. If SCREENEO INNOVATION SA does provide you with Support Services, these will be governed by separate terms to be agreed between you and SCREENEO INNOVATION SA.

**9. Limited Software Warranty.** SCREENEO INNOVATION SA provides the Software "as is" and without any warranty except that the Software will perform substantially in accordance with the documentation accompanying the Software for a period of one year after your first download, installation or use of the Software, whichever occurs first. SCREENEO INNOVATION SA's entire liability and your exclusive remedy for breach of this warranty shall be, at SCREENEO INNOVATION SA's option, either (i) return of the price paid by you for the Software (if any); or (b) repair or replacement of the Software that does not meet the warranty set forth herein and that is returned to SCREENEO INNOVATION SA with a copy of your receipt. This limited warranty shall be void if failure of the Software has resulted from any accident, abuse, misuse or wrongful application. Any replacement Software will be warranted for the remainder of the original warranty period or thirty (30) days, whichever is longer. This limited warranty shall not apply to you if the Software was provided to you free of charge on an evaluation only basis.

**10. No other warranties.** Except as set forth above, SCREENEO INNOVATION SA and its licensors do not warrant that the software will operate error free or uninterrupted, or will meet your requirements. You assume all responsibilities for selection of the software to achieve your intended results, and for the installation of, use of, and results obtained from the software. To the maximum extent permitted by applicable law, SCREENEO INNOVATION SA and its licensors disclaim all warranties and conditions, whether express or implied, including but not limited to the implied warranties of merchantability, fitness for a particular purpose, and accuracy or completeness of results with respect to the software and the accompanying materials. There is no warranty against infringement. SCREENEO INNOVATION SA does not warrant that you will be able to download, copy, store, display, transfer, and/or play secure content.

**11. Limitation of liability.** Under no circumstances will SCREENEO INNOVATION SA or its licensors be liable for any consequential, special, indirect, incidental or punitive damages whatsoever, including, without limitation, damages for loss of profits or revenues, business interruption, loss of business information, loss of data, loss of use or other pecuniary loss, even if SCREENEO INNOVATION SA or its licensors have been advised of the possibility of such damages. In no event shall SCREENEO INNOVATION SA or its licensors aggregate liability for damages arising out of this agreement exceed the greater of the price actually paid by you for the software or five pounds sterling (5.00).

**12. Trademarks.** Certain product names used in this Agreement, the Software, and the printed user documentation may be (registered) trademarks of SCREENEO INNOVATION SA, its licensors or other third parties. You are not authorized to use any such trademarks.

**13. Export Administration.** You agree that you will not directly or indirectly, export or re-export the Software to any country for which the United States Export Administration Act, or any similar United States law or regulation requires an export license or other U.S. Government approval, unless the appropriate export license or approval has first been obtained. By downloading or installing the Software you agree to abide by this Export provision.

**14. Governing Law - Litigations.** This Agreement shall be governed by Swiss Law. Any dispute arising in connection with this Agreement, if not settled amicably, shall be brought to the competent court of Switzerland.

**15. General.** This Agreement contains the entire agreement between you and SCREENEO INNOVATION SA and supersedes any prior representation, undertaking or other communication or advertising with respect to the Software and user documentation. If any part of this Agreement is held invalid, the remainder of this Agreement will continue in full force and effect. This Agreement shall not prejudice the statutory rights of any party dealing as a consumer.

**WARRANTY CARD**  
**GARANTIEKARTE**  
**CARTE DE GARANTIE**  
**TAGLIANDO DI GARANZIA**  
**GARANTIEBEWIJS**  
**TARJETA DE GARANTÍA**  
**CARTÃO DE GARANTIA**  
**GARANTIKORT**  
**GARANTIBEVIS**

**GARANTIKORT**  
**TAKUUKORTTI**  
**JÖTÄLLÄSI JEGY**  
**KARTA GWARANCYJNA**  
**ZÁRUČNÍ LIST**  
**ZÁRUČNÝ LIST**  
**CARTE DE GARANȚI**  
**ГАРАНЦИОННА КАРТА**  
**GARANCIJSKI LIST**

**JAMSTVO KARTICE**  
**ГАРАНТИИ ЛИСТ**  
**ГАРАНТИЙНЫЙ ТАЛОН**  
**KARTA EGΓΥΗΣΗΣ**  
**GARANTI KARTI**  
**CARTÃO DE GARANTIA**  
**THẺ BẢO HÀNH**  
**KAD JAMINAN**  
**ใบรับประกัน**

---

**EN** Dear Customer, you may obtain a copy of the warranty conditions from the dealer, by downloading it from the internet or by contacting the customer support center. Please retain your sales receipt and the warranty card!

---

**DE** Sehr geehrter Kunde, Sie können eine Kopie der Garantiebestimmungen entweder über den Händler erhalten, sie über das Internet herunterladen, oder sie beim Kundendienstzentrum beziehen. Bewahren Sie Ihren Kaufbeleg und die Garantiekarte gut auf!

---

**FR** Très cher client, vous pouvez obtenir une copie des dispositions de garantie chez le vendeur, ou les télécharger sur Internet. Conservez bien votre ticket de caisse et la carte de garantie!

---

**IT** Stimato cliente, una copia delle condizioni di garanzia può essere richiesta tramite il proprio rivenditore, oppure è scaricabile da internet o disponibile presso il servizio post-vendita. Conservare con cura il documento di acquisto e la scheda di garanzia!

---

**NL** Geachte klant, U kunt een kopie van de garantiebegalingen via uw dealer verkrijgen, van Internet downloaden of bij de klantendienst aanvragen. Bewaar uw aankoopbewijs en de garantiekaart goed!

---

**ES** Estimado cliente: puede obtener una copia de las disposiciones de la garantía a través de su distribuidor, descargarla usted mismo por Internet o bien solicitarla en el centro de atención al cliente. Conserve en un lugar seguro el justificante de compra y la tarjeta de garantía!

---

**PT** Estimado cliente, Pode obter uma cópia das condições de garantia no fabricante, descarregá-las da Internet ou adquiri-las no centro de assistência ao cliente. Guarde o comprovativo de compra e o certificado de garantia num local seguro!

---

**SV** Bäste kund, Du kan antingen få en kopia av garantivillkoren via återförsäljaren, ladda ner dem via Internet eller beställa dem hos kundtjänstcentrat. Ta väl vara på ditt kvitto och garantikortet!

---

**DA** Kære kunde, Du kan få en kopi af garantibestemmelserne fra din forhandler eller hos vores kundeservicecenter. Opbevar dit købsbilag og garantikortet omhyggeligt.

---

**NO** Kjære kunde Du kan enten få en kopi av garantibestemmelsene hos forhandleren, laste dem ned fra internettsiden, eller bestille dem ved kundeservicesenteret. Ta godt vare på kjøpsbeviset og garantikortet ditt

---

**FI** Arvoisa asiakas Takuuehdot ovat saatavana tuotteet myyjältä, Internetistä tai asiakaspalvelukeskuksesta. Säilytä kuitti ja takuukortti huolellisesti! Säilytä kuitti ja takuukortti huolellisesti!

---

**CZ** Vážený zákazník, Záruční list obdržíte od prodejce, můžete jej stáhnout z webových stránek, případně kontaktujte zákaznické informační centrum. Ušchovejte, prosíme, účtenku a záruční list!

---

**SK** Vážený zákazník, Záručný list dostanete od predajcu, môžete ho prevziať z webových stránok, prípadne kontaktujte zákaznicke informačné centrum. Ušchovajte, prosíme, účtenku a záručný list!

---

---

**BG** Уважаеми клиенти, Можете да получите копие от гаранционните условия от търговеца или да ги свалите от интернет, както и да ги получите от центъра за обслужване на клиенти. Пазете касовия бон и гаранционната карта!

---

**SL** Spoštovani kupec! Kopijo garancijskih pogojev lahko dobite pri trgovcu, lahko jih prenesete na svoj računalnik preko spleta ali jih dobite pri centru za pomoč strankam. Prosimo, shranite potrdilo o nakupu in garancijski list!

---

**PL** Szanowny Kliencie! Warunki gwarancji można uzyskać od sprzedawcy, pobierając je przez Internet lub kontaktując się z Centrum obsługi klienta. Proszę zachować paragon i kartę gwarancyjną!

---

**SR** Поштоване муштерије Копију гаранцијских одредаба можете добити од трговца, snimiti i učitati preko Interneta ili naručiti preko servisnog centra za mušterije. Pažljivo sačuvajte potvrdu o kupovini i garancijsku karticu!

---

**HR** Poštovane mušterije Kopiju jamstvenih odredaba možete dobiti od trgovca, snimiti i učitati preko Interneta ili naručiti preko servisnog centra za kupce. Potvrdu o kupovini i jamstvenu karticu pažljivo sačuvajte!

---

**HU** Tisztelt Vásárló! A Jótállás egy példányát beszerezheti a forgalmazótól, letöltheti az Internetről vagy kérheti a vevőtájékoztatósi központtól. Kérjük, őrizze meg a vásárlási bizonylatot és a garancia-kártyát! Átalános feltételek: 1. A Fogyasztót a jótállás alapján 15/2003 (IX.22.) Kormányrendeletben meghatározott jogok illetik meg. 2. A jótállás időtartama a vásárlás napjától számított: Fax, Dect, Vezetékes telefon, Digitális fényképező, Photoframe esetén: 12 hónap, kivéve a vetítőlámpa, amire 3 hónap, Multifunkciós berendezés esetén: 24 hónap, Projector esetén: 12 hónap. 3. A jótállási igény a jótállási jeggyel érvényesíthető. A Jótállási jogokat a fogyasztási cikk tulajdonosa érvényesítheti. 4. Tartozékokra (tintafilm, tintapatron) a garancia nem terjed ki. Jótállási kötelezettség kizárása: Ugyeljen a termék használati útmutatójában foglaltak betartására! A jótállási kötelezettség nem áll fenn (például, de nem kizárólagosan) ha a hiba rendeltetésellenes használatból eredő törés, sérülés, szakszerűtlen kezelés vagy illetéktelen átalakítás, helytelen tárolás, beázás, nem megfelelő feszültség használata, elemi csapás vagy az értékesítés utáni külső behatás eredménye. Ilyen esetekben a javítás költségei a Fogyasztót terhelik. Eljárás a hiba jellegére vonatkozó véleménykülönbség, vita esetén: Ha a hiba ténye, jellege megállapításához különleges szakértelem szükséges, a Fogyasztó a Fogyasztóvédelmi Főfelügyelőségtől szakvéleményt kérhet.

---

**TR** Sayın müşterimiz, Garanti kurallarının bir suretini satıcınızdan, internetten indirerek veya ilgili müşteri hizmetleri merkezimizden temin edebilirsiniz. Satın alma belgenizi ve garanti kartınızı itinalı bir biçimde saklayınız!

---

**RU** Уважаемый покупатель, Копию гарантийных обязательств можно получить через дилера, загрузив с вебсайта или получить в сервисном центре. Сохраните документы, подтверждающие покупку, и гарантийный талон!

---

**TR** Stimate client, Puteti obține o copie a prevederilor de garanție fie de la distribuitor, fie o puteți descărca de pe Internet sau o puteți solicita la Serviciul Clienti. Păstrați bonul fiscal/facture în original și certificatul de garanție! Drepturile cumpărătorului sunt în conformitate cu Legea 449/2003 și OG21/1992. Drepturile consumatorului nu sunt afectate de garanția oferită. Asigurarea garanției se face prin repararea/inlocuirea aparatului conform legislației în vigoare de către unitatea de service abilitată de pe acest certificat. Termenul de aducere a produsului la conformitate nu poate depăși 15 zile calendaristice de la data la care consumatorul a reclamat vânăzătorului lipsa conformității. Durata medie de utilizare a produsului : 3,5 ani. Termenul de garanție: 24 luni de la data cumpărării.

---

**CZ** Αγαπητέ Πελάτη, Μπορείτε να πάρετε αντίγραφο των όρων Εγγύησης από τον αντιπρόσωπό σας, να το κατεβάσετε από το διαδίκτυο ή να το πάρετε από το κέντρο Εξυπηρέτησης Πελατών. Φυλάξτε καλά την απόδειξη αγοράς και την κάρτα εγγύησης!

---

**BR** Prezado Cliente, Você pode obter uma cópia das condições de Garantia com o seu fornecedor, descarregá-la da Internet ou até mesmo contatando o nosso centro de assistência ao cliente. Por favor guarde o recibo de compra e o Certificado de Garantia em local seguro!

---



Device type, model and serial number | Gerätetyp, Modell - und Seriennummer | Type d'appareil et numéro de série | Modello e numero di serie | Apparaattype en serienummer | Tipo de aparato y número de serie | Tipo de aparelho e número de série | Apparattype och serienummer | Apparattype og serienummer | Laitteen tyyppi ja sarjanumero | Tipusnev és gyári szám | Nazwa modelu i numer seryjny | Model a sériové číslo | Tipul aparatului, model, numărul declarației de conformitate și numărul serial | Вид на устройството и серийен номер | Tip in serijska številka naprave | Tip uređaja i serijski broj

Date of purchase, invoice number | Kaufdatum, Rechnungsnummer | Date d'achat | Data di acquisto | Aankoopdatum | Fecha de compra | Data de compra | Köpdatum | Købsdato | Kjøpsdato | Ostopäivä | Vásárlás dátuma | Data zakupu | Datum nákupu | Data achiziționării și număr factură | Datum nakupa | Datum kupovin

Name, address, telephone number, stamp and signature of the vendor / retailer | Name, Adresse, Telefonnummer, Stempel und Unterschrift des Verkäufers / Händlers | Cachet du commerçant et signature | Timbro del rivenditore e firma | Firmastempel en handtekening | Sello del distribuidos y firma | Carimbo do revendedor e assinatura | Återförsäljarens stämpel och und namnteckning | Forhandlerstempel og underskrift | Forhandlerens stempel og underskrift | Myyjän leima ja allekirjoitus | Forgalmazó pecsétje és aláírása | Pieczęć i podpis sprzedawcy | Razičko a podpis prodavača | Pečiatka a podpis predavača | Numele, adresa, telefon, ștampila și semnătura vânzătorului | Фирмен печат и подпис | Зиг и подпис трговца | Štambilj trgovca i potpi | Печат трговца и потпис

Name & Address of Customer | Name und Anschrift des Käufers | Nom et adresse de l'acheteur | Nome e recapito dell'acquirente | Naam en adres van de koper | Nombre y dirección del comprador | Nome e morada do cliente | Köparens namn och adress | Kundens navn og adresse | Kjøperens navn og adresse | Asiakkaan nimi ja osoite | A vásárló neve és címe | Nazwa i adres klienta | Jméno a adresa zákazníka | Meno a adresa zákazníka | Numele și adresa cumpărătorului | Име и адрес на купувача

Repair Number	Service Center	Repair Acceptance Date	Return Date	Defect Specification
Număr reparație	Unitate de service	Data przyjęcia do naprawy	Data zwrotu	Specyfikacja usterki
		Javitásra átvétel dátuma Datum přijetí do opravy	Visszaadás dátuma Datum vráčení	Hilba leirása Popis závady
		Data receptiei	Data înapoierii	Descrierea defectiunii

Description of the Repair Opis naprawy A javítás leírása Popis opravy Descrierea reparației	Spare Part(s)/Nr. Część(-ci) zamienna(-e)/nr Alkatrész / szám Náhradní díl(y) / č. Piese de schimb / număr	Warranty Period of the New Component(s) / Stamp Az új alkatrészek jótállási időtartama / Pecset Záruční doba vyměněných částí / razítko Perioada de garanție pentru piesele noi / ștampila



<b>COUNTRY</b>	<b>HOTLINE</b>
Argentina	See international support
Australia	1800 251 367
Austria	+43 720 881 525
Belgium	+32 78 077 761 (FR) / 209 (NL)
Brasil	+55 85 4042 1414
Bulgaria	See international support
Canada	+1 (873) 514-1003
Chile	+56 2249 94507
Colombia	+57 1 328 8975
Croatia	See international support
Czech Republik	+420 910 880 087
Denmark	+45 78 76 93 84
Egypt	+20 111 456 1786
Estonia	+3726166480
Finland	+358 75325 82 56
France	+33 6 44 60 30 83
Germany	+49 421 836 79789
Great Britain	+44 131 322 1364
Greece	+30 261 118 0299
China	(+86)01059357346
Hong Kong SAR	+852 3183 0168
Hungary	+36 1 998 9144
Indonesia	+62 855 7467 6380
Ireland	+353 76 680 5635
Israel	+972-8-9418222
Italy	+39 0 776 1580046
Japan	+81-50-3205-0854
Latvia	+37166155194

Lithuania	+37052351699
Luxemburg	+352 2786 21 07
Malaysia	+60 16 299 1498
Mexico	+52 55 4166 7410
Morocco	+212 641 631 095
Netherlands	+31 85 0013 738
New Zealand	0800 426 237
Norway	+47 21 95 41 81
Poland	+48 61 880 12 15
Portugal	See international support
Puerto Rico	+1 (787) 305-3813
Romania	+40 31 630 5446
Russia	+749 5148 82 08
Serbia	See international support
Singapore	+65 6841 2668
Slovakia	See international support
Slovenia	See international support
Spain	+34 518 889 132
Sweden	+46 8 580 97 043
Switzerland	+41 21 539 16 66 (DE) / 67 (IT) / 68 (FR)
Turkey	+ 90 (212) 2697676
UAE	+971 4 4473106
USA	+1 (812) 308-4615

**International customer support:**

**+41 21 53 91 665**

@ philips.projector.eu@screeeneo.com

🌐 www.philips.com/support and our Community: <https://community.screeeneo.com>

#### RED Caution

The product shall be connected to a USB interface of version USB2.0 or higher.

The operating temperature of the EUT can't exceed 35 Degrees Celsius and shouldn't be lower than 0 Degree Celsius.

Only indoor use for band 5150-5350MHz.

Hereby, Screeneo Innovation SA declares that this product is in compliance with essential requirements and other relevant provisions of Directive 2014/53/EU. This product is allowed to be used in all EU member states.

The Bluetooth® word mark and logos are registered trademarks owned by Bluetooth SIG, Inc. and any use of such marks by Screeneo Innovation SA is under license. Other trademarks and trade names are those of their respective owners.

The terms HDMI, HDMI High-Definition Multimedia Interface, HDMI trade dress and the HDMI Logos are trademarks or registered trademarks of HDMI Licensing Administrator, Inc.

FCC ID: 2ASRT-SCN550

FCC Warning

#### 15.19 Labeling requirements.

This device complies with part 15 of the FCC Rules. Operation is subject to the following two conditions:

(1) This device may not cause harmful interference, and (2) this device must accept any interference received, including interference that may cause undesired operation.

#### 15.21 Information to user.

Any Changes or modifications not expressly approved by the party responsible for compliance could void the user's authority to operate the equipment.

#### 15.105 Information to the user.

Note: This equipment has been tested and found to comply with the limits for a Class B digital device, pursuant to part 15 of the FCC Rules. These limits are designed to provide reasonable protection against harmful interference in a residential installation. This equipment generates uses and can radiate radio frequency energy and, if not installed and used in accordance with the instructions, may cause harmful interference to radio communications. However, there is no guarantee that interference will not occur in a particular installation. If this equipment does cause harmful interference to radio or television reception, which can be determined by turning the equipment off and on, the user is encouraged to try to correct the interference by one or more of the following measures:

-Reorient or relocate the receiving antenna.

#### Frequency bands

2412-2472MHz

2402-2480MHz

5150-5725MHz

5725-5850MHz

#### Maximum output power (EIRP)

16.35dBm

13.71dBm

16.18dBm

13.45dBm



-Increase the separation between the equipment and receiver.

-Connect the equipment into an outlet on a circuit different from that to which the receiver is connected.

-Consult the dealer or an experienced radio/TV technician for help.

1. This Transmitter must not be co-located or operating in conjunction with any other antenna or transmitter.
2. This equipment complies with RF radiation exposure limits set forth for an uncontrolled environment.
3. This equipment should be installed and operated with minimum distance 20cm between the radiator & your body.

## SIMPLIFIED EU DECLARATION OF CONFORMITY FOR RADIO DEVICE

<b>DE</b>	Hiermit erklärt Screeneo Innovation SA, dass die Geräte in Übereinstimmung mit den Richtlinien 2014/53/EU, 2009/125/EG, 2011/65/EU sind. Der vollständige Wortlaut der EU-Konformitätserklärung steht unter folgender Internet Adresse zur Verfügung: <a href="http://www.philips.com">www.philips.com</a>
<b>FR</b>	Par la présente, Screeneo Innovation SA déclare que l'équipement est en conformité avec les directives 2014/53/EU, 2009/125/EC, 2011/65/EU. Le texte complet de la déclaration de conformité européenne est disponible à l'adresse internet suivante : <a href="http://www.philips.com">www.philips.com</a>
<b>EN</b>	Hereby, Screeneo Innovation SA declares that the equipment is in compliance with Directives 2014/53/EU, 2009/125/EC, 2011/65/EU. The full text of the EU declaration of conformity is available at the following internet address: <a href="http://www.philips.com">www.philips.com</a>
<b>IT</b>	Con la presente, Screeneo Innovation SA dichiara che il prodotto è conforme alle direttive 2014/53/EU, 2009/125/EC e 2011/65/EU. Il testo completo della dichiarazione europea di conformità è disponibile al seguente link: <a href="http://www.philips.com">www.philips.com</a>
<b>ES</b>	Por medio de la presente, SCREENEO INNOVATION SA declara que el equipo cumple con las Directrices 2014/53/UE, 2009/125/CE, 2011/65/UE. El texto completo de la declaración de conformidad de la UE está disponible en la siguiente dirección Internet: <a href="http://www.philips.com">www.philips.com</a>
<b>NL</b>	Screeneo Innovation SA verklaart hiermee dat de uitrusting aan de Directieven 2014/53/EU, 2009/125/EC, 2011/65/EU voldoet. De volledige tekst van de EU-conformiteitsverklaring is terug te vinden op het volgende internetadres: <a href="http://www.philips.com">www.philips.com</a>
<b>PT</b>	A Screeneo Innovation SA declara que o equipamento está em conformidade com as Directivas 2014/53/UE, 2009/125/CE, 2011/65/UE. O texto integral da declaração de conformidade da UE está disponível através do seguinte endereço da Internet: <a href="http://www.philips.com">www.philips.com</a>
<b>SW</b>	Härmed , försäkrar Screeneo Innovation SA att utrustningen är i enlighet med direktiven 2014/53/EU, 2009/125/EG, 2011/65/EU. Den fullständiga texten av EU-försäkran om överensstämmelse finns på följande internetadress: <a href="http://www.philips.com">www.philips.com</a>
<b>DK</b>	Herved , erklærer Screeneo Innovation SA , at udstyret er i overensstemmelse med direktiv 2014/53/EU , 2009/125/EF , 2011/65/EU. Den fulde tekst af EU-overensstemmelseserklæringen er tilgængelig på følgende internetadresse : <a href="http://www.philips.com">www.philips.com</a>
<b>NO</b>	Screeneo Innovation SA erklærer herved at apparatene er i samsvar med direktivene 2014/53/EU, 2009/125/EG, 2011/65/EU. Den komplette teksten for EU-samsvarserklæringen er tilgjengelig på følgende internett-adresse: <a href="http://www.philips.com">www.philips.com</a>

NORTH AMERICA Service Center:  
Cooper General Global Services, Inc.  
Attn: Screeneo/Philips  
920 Minters Chapel Road, Suite 600  
Grapevine, TX 76051

Philips and the Philips Shield Emblem are registered trademarks of Koninklijke Philips N.V. and are used under license. This product has been manufactured by and is sold under the responsibility of Screeneo Innovation SA, and Screeneo Innovation SA is the warrantor in relation to this product.

Screeneo Innovation SA  
Route de Lully 5C  
1131 - Tolochenaz - Switzerland  
[www.philips.com](http://www.philips.com)  
[philips.projector.eu@screeneo.com](mailto:philips.projector.eu@screeneo.com)

EUROPEAN Service Center:  
Euro Repair Center  
Europa-Allee-77  
54343 Föhren  
Germany

<b>FI</b>	Screeneo Innovation SA vakuuttaa täten, että laitteisto täyttää direktiivien 2014/53/EY, 2009/125/EY, 2011/65/EY vaatimukset. Täydellinen EY-vaatimustenmukaisuusvakuutus on luettavissa seuraavasta verkko-osoitteesta: <a href="http://www.philips.com">www.philips.com</a>
<b>CZ</b>	Společnost Screeneo Innovation SA tímto prohlašuje, že toto zařízení odpovídá požadavkům směrnice 2014/53/EU, 2009/125/ES a 2011/65/EU. Celý text prohlášení o shodě platném pro EU je k dispozici na následující internetové adrese: <a href="http://www.philips.com">www.philips.com</a>
<b>SK</b>	Týmto spoločnosť Screeneo Innovation SA prehlasuje, že vybavenie je v súlade s normami 2014/53/EÚ, 2009/125/ES, 2011/65/EÚ. Kompletný text vyhlásenia o zhode s EU je dostupný na nasledujúcej internetovej adrese: <a href="http://www.philips.com">www.philips.com</a>
<b>HU</b>	Screeneo Innovation SA ezennel kijelenti, hogy a készülék teljesíti a 2014/53/EU, 2009/125/EC, 2011/65/EU irányelveket. Az EU megfelelőségi nyilatkozat teljes szövege a következő internet címen érhető el: <a href="http://www.philips.com">www.philips.com</a>
<b>PL</b>	Niniejszym Screeneo Innovation SA deklaruje, że urządzenia są zgodne z wymogami dyrektyw 2014/53/UE, 2009/125/WE, 2011/65/UE. Pełny tekst deklaracji zgodności UE jest dostępny na następującej stronie internetowej: <a href="http://www.philips.com">www.philips.com</a>
<b>TR</b>	Bu vesile ile Screeneo Innovation SA, Cihaz Direktifleri 2014/53/EU, 2009/125/EC, 2011/65/EU ile uyumlu olduğunu beyan eder. AB uyumluluk beyanı tam metni aşağıdaki internet adresinde mevcuttur: <a href="http://www.philips.com">www.philips.com</a>
<b>GR</b>	Δια του παρόντος, η Screeneo Innovation SA δηλώνει ότι ο εξοπλισμός έχει συμμορφωθεί με τις οδηγίες 2014/53/EU, 2009/125/EC, 2011/65/EU. Ολόκληρο το κείμενο της Ευρωπαϊκής δήλωσης συμμόρφωσης είναι διαθέσιμο στην ακόλουθη διεύθυνση Internet: <a href="http://www.philips.com">www.philips.com</a>
<b>RO</b>	Prin prezenta, Screeneo Innovation SA declara ca echipamentul este in conformitate cu Directivale Europene 2014/53/EU, 2009/125/EC, 2011/65/EU. Textul integral al declaratiei de conformitate UE este disponibil la urmatoarea adresa de internet: <a href="http://www.philips.com">www.philips.com</a>
<b>BG</b>	С настоящото, Screeneo Innovation SA декларира, че оборудването е в съответствие с директиви 2014/53/ЕС, 2009/125/ЕО, 2011/65/ЕС. Пълният текст на ЕС декларацията за съответствие е достъпна на следния интернет адрес: <a href="http://www.philips.com">www.philips.com</a>
<b>HR</b>	Screeneo Innovation SA ovim putem izjavljuje da je oprema uskladená sa smjernicama 2014/53/EU, 2009/125/EC, 2011/65/EU. Puni tekst EU deklaracije uskladenosti dostupan je na sljedećoj internoj adresi: <a href="http://www.philips.com">www.philips.com</a>
<b>RS</b>	Ovim Screeneo Innovation SA izjavljuje da su uređaji usaglašeni sa direktivama 2014/53/EU, 2009/125/EG, 2011/65/EU. Kompletan tekst EU izjave o usaglašenosti je dostupan na sledećoj internet adresi: <a href="http://www.philips.com">www.philips.com</a>

