

PHILIPS

MVL1098



>75% recycled paper
>75% papier recyclé

© 2019 Koninklijke Philips N.V.

All rights reserved

保留所有权利

4222.002.9182.1 (6/3/2019)

> 75% 循环再造纸

保留备用

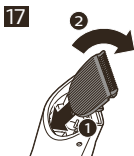
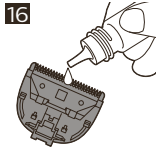
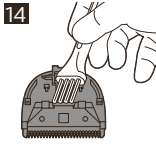
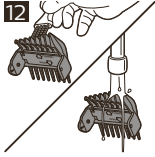
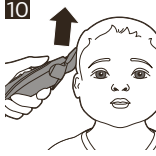
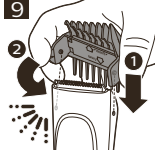
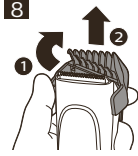
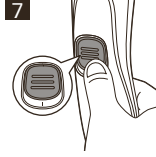
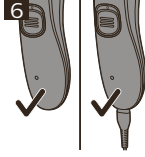
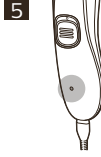
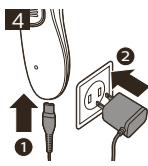

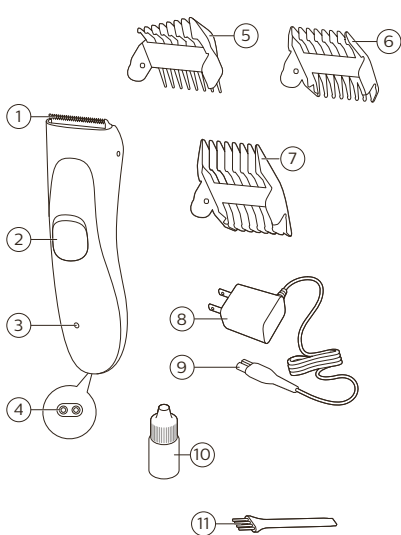

English

Introduction

Congratulations on your purchase and welcome to Philips! To fully benefit from the support that Philips offers, register your product at www.philips.com/welcome.

Your new Philips kid hair clipper allows you to give your child a professional haircut in the comfort of your own home. The ultra-silent motor and child-safe, lightweight and waterproof design makes cutting hair a pain-free, easy experience for you and your child. The professional blade with the specially designed rounded tips combined with multiple-length combs, helps you to safely create a smooth, even cut, every time.

General description (Fig. 1)

- 1 Cutting unit
- 2 On/off slide
- 3 Charging indicator
- 4 Socket for small plug
- 5 Ear contouring comb (1 mm/1-9 mm)
- 6 Hair comb (3 mm/6 mm)
- 7 Hair comb (9 mm/12 mm)
- 8 Supply unit
- 9 Small plug
- 10 Bottle of sewing machine oil
- 11 Cleaning brush

Important safety information

Read this important information carefully before you use the appliance and its accessories and save it for future reference. The accessories supplied may vary for different products.

Danger

- Keep the supply unit dry (Fig. 2).

Warning

- To charge the battery, only use the detachable supply unit (type HQ8507) provided with the appliance.
- The supply unit contains a transformer. Do not cut off the supply unit to replace it with another plug, as this causes a hazardous situation.
- This appliance can be used by children aged from 8 years and above and persons with reduced physical, sensory or mental capabilities or lack of experience and knowledge if they have been given supervision or instruction concerning use of the appliance in a safe way and understand the hazards involved. Children shall not play with the appliance. Cleaning and user maintenance shall not be made by children without supervision.
- Detach the hand-held part from the supply cord before cleaning it in water.
- Always check the appliance before you use it. Do not use the appliance if it is damaged, as this may cause injury. Always replace a damaged part with one of the original type.
- This appliance contains batteries that are non-replaceable.
- Do not open the appliance to replace the rechargeable battery.

Caution

- Never immerse the appliance in water. Do not use the appliance in the bath or shower.
- Never use water hotter than 60°C to rinse the appliance.
- Only use this appliance for its intended purpose as shown in the user manual.
- If you use the appliance to clip the hair of more than one child, clean the appliance before you use it on another child.
- Never use compressed air, scouring pads, abrasive cleaning agents or aggressive liquids such as petrol or acetone to clean the appliance.
- Do not use the supply unit in or near wall sockets that contain an electric air freshener to prevent irreparable damage to the supply unit.

Electromagnetic fields (EMF)

This Philips appliance complies with all applicable standards and regulations regarding exposure to electromagnetic fields.

General

- This appliance can be safely cleaned under the tap (Fig. 3).

- The supply unit is suitable for mains voltages ranging from 100 to 240 volts.
- The supply unit transforms 100-240 volts to a safe low voltage of less than 24 volts.

Preparing for use

Charging

Charge the appliance for at least 8 hours before you use it for the first time, after a long period of non-use or when the motor starts to run more slowly during hair clipping.

When the appliance is fully charged, the appliance has a cordless operating time of up to 45 minutes.

Note: Do not leave the appliance connected to the wall socket for more than 24 hours

- 1 Switch off the appliance.
- 2 Insert the small plug into the appliance and put the supply unit in the wall socket (Fig. 4).
 - After a few seconds, the charging indicator lights up green continuously to indicate that the appliance is charging (Fig. 5).
- 3 After charging (approx. 8 hours), remove the supply unit from the wall socket and pull the small plug out of the appliance.

Charge indications

Battery low

The battery status is indicated by the performance of the appliance. When the appliance starts working more slowly, the battery is almost empty and needs to be charged for optimal performance.

Charging

When you charge the appliance, the charging indicator lights up green continuously to indicate that the appliance is charging (Fig. 5).

Using the appliance

Note: This appliance can be used without cord or when it is connected to the wall socket (Fig. 6).

Switching the appliance on and off

- To switch on the appliance, push the on/off slide upwards (Fig. 7).
- To switch off the appliance, push the on/off slide downwards.

Removing or attaching combs

- 1 To remove the comb, push one lug backwards off the appliance until the comb detaches from the appliance (Fig. 8).
- 2 To attach the comb, make sure the side with the desired hair length points upwards. Fit one of the projections on the inside of the lug into the small hole on the side of the appliance. Push the other lug of the comb into place ('click') (Fig. 9).

Note: Please make sure that the lugs of the comb have been properly inserted into the holes on both sides of the appliance.

Before use

- For optimal safety, we advise you to always use the appliance with a comb.
- This appliance is only intended for clipping human scalp hair. Do not use it for another purpose.
- When you clip hair for the first time, start with the comb with the highest length to familiarize yourself with the appliance.
- Make sure the hair is clean and dry. Do not use the appliance on wet hair.
- Make sure the head of the person whose hair you are cutting is at the same level as your chest. This ensures that all parts of the head are clearly visible and within easy reach.

Hair clipping with comb

The appliance comes with different hair combs. Each side of each comb cuts to a different fixed hair length. The indication on the inside of each comb corresponds to the remaining hair length after clipping.

Ear contouring comb	1 mm/1-9 mm
Hair comb	3 mm/6 mm
Hair comb	9 mm/12 mm

- 1 Comb the hair in the direction of hair growth.
- 2 Attach the desired comb onto the appliance (see 'Removing or attaching combs').
- 3 To clip the hair, move the appliance through the hair slowly. Make sure that the flat part of the comb is in full contact with the scalp to obtain an even cutting result (Fig. 10).

Hair clipping tips

- To clip most effectively, move the appliance against the hair growth direction.
- Move the appliance in different directions (upward, downward or across), because hair doesn't all grow in the same direction.
- Make overlapping passes over the head to ensure that the appliance catches all the hairs that need to be cut.
- Write down which comb(s) you use to create a certain hairstyle as a reminder for future clipping sessions.
- Regularly remove cut hair from the comb. If a lot of hair has accumulated in the comb, remove it from the appliance and blow and/or shake out the hairs (see 'Cleaning').

Cleaning

Never dry the cutting unit with a towel or tissue, as this may damage the trimming teeth.

Clean the appliance every time you have used it. Only clean the appliance with the cleaning brush supplied.

Never use scouring pads, abrasive cleaning agents or aggressive liquids such as alcohol, petrol or acetone to clean the appliance.

- 1 Switch off the appliance and disconnect it from the wall socket.
- 2 Wipe the housing of the appliance with a dry cloth (Fig. 11).

- Remove the comb and clean it with the cleaning brush and/or rinse it under the tap (Fig. 12).
- Push the teeth of the cutting unit upwards to remove it from the appliance (Fig. 13).
- Clean the cutting unit with the cleaning brush and/or rinse it under the tap (Fig. 14).
- Clean the inside of the appliance with the brush and/or rinse it under the tap (Fig. 15).
- Carefully shake off excess water and let all parts dry.
- For optimal performance, lubricate the teeth of the cutting unit with a drop of sewing machine oil regularly (Fig. 16).
- Insert the lug of the cutting unit into the guiding slot and push the cutting unit back onto the appliance.

Replacement

Replace damaged parts immediately. Always replace the cutting unit with the original Philips cutting unit.

- Push the teeth of cutting unit upwards and pull the cutting unit off the appliance (Fig. 13).
- Remove the used cutting unit.
- Insert the lug of the new cutting unit into the guiding slot and push the cutting unit onto the appliance ('click') (Fig. 17).

Recycling

- Do not throw away the product with the normal household waste at the end of its life, but hand it in at an official collection point for recycling. By doing this, you help to preserve the environment.
- This product contains a built-in rechargeable battery which shall not be disposed of with normal household waste. Please take your product to an official collection point or a Philips service center to have a professional remove the rechargeable battery.
- Follow your country's rules for the separate collection of electrical and electronic products and rechargeable batteries. Correct disposal helps prevent negative consequences for the environment and human health.

Removing the rechargeable battery

The battery must be removed from the appliance before it is scrapped.

The appliance must be disconnected from the supply mains when removing the battery.

The battery is to be disposed of safely.

- Check if there are screws in the back or front of the appliance. If so, remove them.
- Remove the back and/or front panel of the appliance with a screwdriver. If necessary, also remove additional screws and/or parts until you see the printed circuit board with the rechargeable battery.
- Remove the rechargeable battery.

Troubleshooting

This chapter summarizes the most common problems you could encounter with the product. If you are unable to solve the problem with the information below, visit www.philips.com/support for a list of frequently asked questions or contact the Consumer Care Center in your country.

Problem	Possible cause	Solution
The appliance produces an uneven cutting result.	The comb does not touch the scalp when you move the appliance through the hair.	Make sure that the flat part of the comb is always fully in contact with the scalp when you move the appliance through the hair.
	You used the appliance on wet hair.	Make sure the hair is clean and dry. Do not use the appliance on wet hair.
	You only move the appliance in one direction.	Move the appliance in different directions (upward, downward or across), because hair doesn't all grow in the same direction.
	The comb is not correctly attached to the cutting unit.	Remove the comb and reattach it. Put the comb into the slots on both sides of the appliance ('click').
	The cutting unit and/or the comb are dirty.	Clean the cutting unit and/or the comb (see 'Cleaning').
	The cutting performance decreases when the battery runs low.	Charge the battery or connect the appliance to the wall socket and use the appliance with cord.
The appliance does not work when I press the on/off button.	The rechargeable battery is empty.	Charge the battery (see 'Preparing for use').

	The appliance is not connected to the wall socket.	Insert the small plug into the appliance and put the supply unit in the wall socket. You can also use the appliance when it is connected to the wall socket.
The charging indicator does not light up green to indicate that the appliance is charging when I connect the appliance to the wall socket.	There is a power failure or the wall socket is not live.	Check if the power supply is working. If it is, check whether the socket is live by plugging in another appliance.

简体中文

简介

感谢您的惠顾，很高兴您选择飞利浦！为了让您能充分享受飞利浦提供的支持，请在 www.philips.com/welcome 上注册您的产品。

全新飞利浦宝宝理发器让您可以在自己家中舒适地为您的宝宝理出专业发型。安全、轻便和防水设计及超静音马达让您和孩子轻松享受理发过程。采用特制安全圆润刀头结合多个尺寸的梳齿，帮您每次都能安全地理出平滑、均匀的发型。

基本说明 (图 1)

- 1 修剪部件
- 2 开/关按钮
- 3 充电指示灯
- 4 小插头插座
- 5 耳边梳 (1 毫米/1-9 毫米)
- 6 定长梳齿 (3 毫米/6 毫米)
- 7 定长梳齿 (9 毫米/12 毫米)
- 8 电源部件
- 9 小插头
- 10 油瓶
- 11 清洁刷

重要安全信息

使用本产品及其附件之前，请仔细阅读本重要信息，并妥善保管以供日后参考。随附的附件可能因产品而异。

危险

- 保持电源部件干燥 (图 2)。
- 警告符号注释：禁止在打开的水龙头下进行清洗 (图 2)。

警告

- 要给电池充电，请仅使用产品随附的可拆卸电源部件 (类型 HQ8507)。
- 电源部件中包含一个变压器。请勿自行更换电源部件的插头，否则将导致严重后果。
- 本产品也可以由 8 岁或以上年龄的儿童以及肢体不健全、感觉或精神上有障碍或缺乏相关经验和知识的人士使用，但前提是有人对他们使用本产品进行监督或指导，以确保他们安全使用，并且让他们明白相关的危害。切勿让儿童玩弄本产品。不要让儿童在无人监督的情况下对本产品进行清洁和保养。
- 将手持部分与电源软线分开后，才能在水中清洗手持部分。
- 使用前，请务必检查产品。请勿使用损坏的产品，否则可能对人体造成伤害。请务必用原装型号更换损坏的部件。
- 本产品包含的电池不可更换。
- 切勿拆开本产品更换充电电池。

警告

- 切勿将产品浸入水中。请勿在洗澡或淋浴时使用本产品。
- 切勿使用温度高于 60° C 的热水冲洗本产品。
- 只能将本产品用于用户手册中所示的原定用途。
- 如果使用产品给多个孩子修剪头发，请在用于其他孩子前清洁本产品。
- 切勿使用压缩气体、钢丝绒、研磨性清洁剂或腐蚀性液体 (例如汽油或丙酮) 来清洁产品。

- 请勿在包含电动空气清新器的墙壁插座上或其周围使用电源部件，以免电源部件受到不可修复的损坏。

电磁场 (EMF)

本 Philips 产品符合所有有关暴露于电磁场的适用标准和法规。

概述

- 该产品可放心在水龙头下 (图 3) 清洗。
- 符号注释：适合用在打开的水龙头下进行清洗 (图 3)。
- 电源部件适合在 100 - 240 伏的电源电压下工作。
- 该电源部件可将 100-240 伏的电压转换为 24 伏以下的安全低电压。

使用准备

充电

在第一次使用前、长时间没有使用后或在理发过程中马达开始变慢，要给本产品至少充电 8 个小时。

充满电后，产品可在不接电源的情况下工作长达 45 分钟。

注意： 不要将本产品与电源插座接通超过 24 小时

- 1 关闭产品。
- 2 将充电插头插入产品，然后将电源部件插入电源插座 (图 4)。
 - 几秒钟之后，充电指示灯呈绿色持续亮起，表示产品正在充电 (图 5)。
- 3 充电之后 (大约 8 小时)，从电源插座上拔下电源部件，并从产品上拔下充电插头。

充电指示

电池电量不足

产品性能可反映电池电量状态。当产品开始工作得越来越慢时，表示电池电量几乎耗尽，需要充电才能获得最佳性能。

正在充电

为产品充电时，充电指示灯呈绿色持续亮起，表示产品正在充电 (图 5)。

使用本产品

注意： 本产品既可以在不接电源的情况下使用，也可连接电源插座 (图 6) 使用。

打开或关闭产品

- 要打开本产品，请向上 (图 7) 滑动开/关按钮。
- 要关闭本产品，请向下滑动开/关按钮。

拆卸或安装梳齿

- 1 要取下梳齿，从产品向后推动一侧凸缘，直至梳齿从产品 (图 8) 卸下。
- 2 要安装梳齿，请确保标有所需头发长度标识的一面朝上。将凸缘内部的一个凸起部位装入产品侧面的小孔。将梳齿的另一个凸缘推入到位 (可听到“咔哒”一声) (图 9)。

注意： 请确保梳齿的凸缘正确装入产品两侧的孔中。

使用前的准备工作

- 为了实现最大的安全性，建议始终带有梳齿使用本产品。
- 本产品仅限于修剪人类头发。请勿将其用作任何其它用途。
- 第一次修剪头发时，建议使用最大长度的梳齿开始修剪，以便熟悉产品的使用方法。
- 确保头发清洁干燥。请勿对过湿的头发使用本产品。
- 确保要剪发的人的头部与您的胸部处于同一水平。这将确保能够清楚地看到整个头部并可轻松触及。

使用梳齿修剪头发

本产品随附不同长度的定长梳齿。各个梳齿的每侧可修剪到不同的固定头发长度。每个梳齿内的标识表示剪发后剩余的头发长度。

耳边梳	1 毫米/1-9 毫米
-----	-------------

定长梳齿	3 毫米/6 毫米
------	-----------

定长梳齿	9 毫米/12 毫米
------	------------

- 1 按头发生长的方向梳理头发。
- 2 将所需的梳齿安装到本产品 (请参见‘拆卸或安装梳齿’) 上。

- 要修剪头发，请将本产品在头发上缓缓移动。确保梳齿的扁平部分完全接触到头皮，以获得均匀的修剪效果(图 10)。

头发修剪提示

- 要获得最大修剪效率，请沿头发生长的反方向移动本产品。
- 向不同的方向（向上、向下或交叉）移动本产品，因为头发不会全部朝相同的方向生长。
- 在整个头部重复修剪动作，以确保产品捕捉到所有需要修剪的头发。
- 记下您使用的梳齿，用作未来剪发过程中创造某种发型的参考。
- 定期清除梳齿上的残留头发。如果梳齿中积聚了许多头发，请将梳齿从产品上卸下，将头发(请参见‘清洁’)吹出或甩出。

清洁

切勿用毛巾或纸巾擦拭修剪部件，否则可能会损坏修剪齿。

每次使用后都要清洁产品。

仅使用随附的清洁刷清洁产品。

切勿使用钢丝绒、研磨性清洁剂或腐蚀性液体（例如酒精、汽油或丙酮）来清洁产品。

- 1 关闭产品并与电源插座断开连接。
- 2 使用干布(图 11)擦拭产品表面。
- 3 取下修剪梳，然后用清洁刷进行清洁和/或放在水龙头(图 12)下冲洗。
- 4 将修剪部件的修剪齿向上推，将其从本产品(图 13)上取下。
- 5 用清洁刷清洁修剪部件和/或将其放在水龙头(图 14)下冲洗。
- 6 用清洁刷清洁产品内部和/或在水龙头(图 15)下冲洗。
- 7 小心地甩掉多余的水份并让所有部件干燥。
- 8 为获得最佳效果，请定期(图 16)用随附的润滑油涂抹在刀头上进行保养
- 9 将修剪部件的凸缘插入导向槽，然后将修剪部件推回到产品上。

更换

立即更换损坏的部件。请务必用原装飞利浦修剪部件更换修剪部件。

- 1 将修剪部件的修剪齿向上推，从本产品(图 13)中拉出修剪部件。
- 2 取下用过的修剪部件。
- 3 将新修剪部件的凸缘插入导向槽，然后将修剪部件推到产品上（可听到“咔哒”一声）(图 17)。

回收

- 弃置本产品时，请不要将其与一般生活垃圾放在一起，应将其交给政府指定的回收中心。这样做将有利于环保。
- 此产品包含内置充电电池；请勿将充电电池与一般生活垃圾一起弃置。请您将产品送到官方收集中心或飞利浦服务中心，请专业人士移除充电电池。
- 遵循您的国家/地区有关分类回收电子电气产品和充电电池的规定。正确弃置产品有助于避免对环境和人类健康造成不良后果。

拆下充电电池

必须从产品上卸下电池，然后才能将其弃置。

卸下电池时，请确保产品与电源断开连接。

请安全弃置电池。

- 1 检查产品的前面和后面是否有螺丝。如果有，请将其拆下。
- 2 用螺丝刀卸下产品的前面板和/或后面板。必要时还需要拆下更多的螺丝和/或部件，直到您看见装有充电电池的印刷电路板为止。
- 3 拆下充电电池。

部件名称	产品中有害物质的名称及含量					
	有害物质					
	铅 (Pb)	汞 (Hg)	镉 (Cd)	六价铬 (Cr (VI))	多溴联苯 (PBB)	多溴二苯醚 (PBDE)
Internal metal parts 内部金属件	X	○	○	○	○	○

本表格依据SJ/T 11364的规定编制。

○: 表示该有害物质在该部件所有均质材料中的含量均在GB/T 26572规定的限量要求以下。

X: 表示该有害物质至少在该部件的某一均质材料中的含量超出GB/T 26572规定的限量要求。

- 该表格中所显示的“有害物质”在产品正常使用情况下不会对人身和环境产生任何伤害。

- 该表格中所显示的“有害物质”及其存在的部件向消费者和回收处理从业者提供相关物质的存在信息，有助于产品废弃时的妥善处理。

故障处理方法

本章归纳了使用本产品最常遇到的问题。如果您无法根据以下信息解决问题，请访问 www.philips.com/support 查阅常见问题列表，或联系您所在国家/地区的客户服务中心。

故障排除表格

问题	可能的原因	解决方法
产品的修剪效果不均匀。	产品在头发上推动时没有触碰头皮。	在头发上推动产品时，请确保梳齿的扁平部分可始终与头皮完全接触。
	您在湿发上使用本产品。	确保头发清洁干燥。请勿对过湿的头发使用本产品。
	您只向一个方向移动产品。	向不同的方向（向上、向下或交叉）移动本产品，因为头发不会全部朝相同的方向生长。
	梳齿未正确安装到修剪部件上。	卸下梳齿，重新安装。将修剪梳放入产品两侧的导槽中（可听到“咔哒”一声）。
	修剪部件和/或梳齿不干净。	清洁修剪部件和/或修剪梳（请参见‘清洁’）。
	电池电量低时，修剪性能会下降。	给电池充电或将产品连接到电源插座，连接电源使用本产品。
按下开/关按钮时，产品不工作。	充电电池的电量已耗尽。	给电池（请参见‘使用准备’）充电。
	产品没有连接电源插座。	将充电插头插入产品，然后将电源部件插入电源插座。本产品还能连接电源插座使用。
当产品连接至电源插座时，充电指示灯未呈绿色亮起。	可能是电源故障或插座没电。	检查电源是否工作。如果有，在插座中插入另一产品检查插座是否通电。

PHILIPS

产品：飞利浦宝宝理发器
 型号：MVL1098
 额定电压：220V~
 额定频率：50Hz
 额定输入功率：7.5W
 生产日期：请见产品本体
 产地：中国浙江宁波

IPX4



飞利浦（中国）投资有限公司
 上海市静安区灵石路718号A1幢
 全国顾客服务热线: 4008 800 008

本产品根据国标 GB4706.1-2005, GB4706.9-2008制造

保留备用

发行日期: 6/3/2019