

PHILIPS

7000 series

S7740

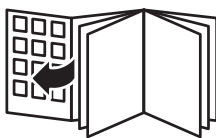



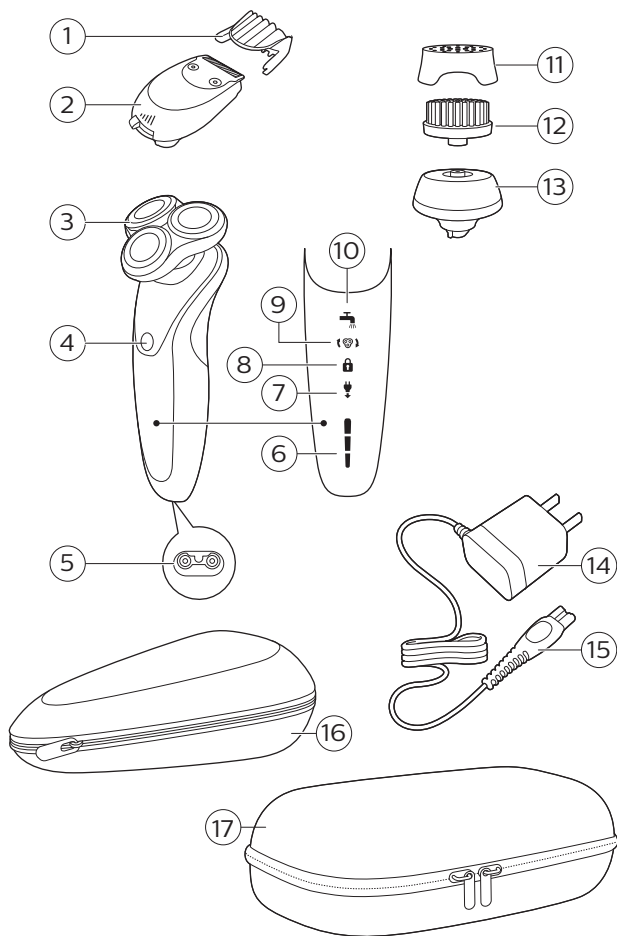

English 6

简体中文 **28**

Introduction

Congratulations on your purchase and welcome to Philips! To fully benefit from the support that Philips offers, register your product at www.philips.com/welcome.

General description

- 1 Beard styler comb
- 2 Click-on beard styler attachment
- 3 Click-on shaving unit
- 4 On/off button
- 5 Socket for small plug
- 6 Battery charge indicator with 3 lights
- 7 Unplug for use symbol
- 8 Travel lock symbol
- 9 Replacement reminder
- 10 Cleaning reminder
- 11 Protection cap for cleansing brush
- 12 Click-on cleansing brush attachment
- 13 Attachment base
- 14 Supply unit
- 15 Small plug
- 16 Small pouch
- 17 Big pouch

Danger



- Keep the supply unit dry.

Warning

- To charge the battery, only use the detachable supply unit (HQ80) provided with the appliance.

- The supply unit contains a transformer. Do not cut off the supply unit to replace it with another plug, as this causes a hazardous situation.
- This appliance can be used by children aged from 8 years and above and persons with reduced physical, sensory or mental capabilities or lack of experience and knowledge if they have been given supervision or instruction concerning use of the appliance in a safe way and understand the hazards involved. Children shall not play with the appliance. Cleaning and user maintenance shall not be made by children without supervision.
- Always unplug the shaver before you clean it under the tap.
- Always check the appliance before you use it. Do not use the appliance if it is damaged, as this may cause injury. Always replace a damaged part with one of the original type.
- Do not open the appliance to replace the rechargeable battery.

Caution



- Never immerse the cleaning system or the charging stand in water and do not rinse it under the tap.
- Never use water hotter than 60°C to rinse the shaver.
- Only use this appliance for its intended purpose as shown in the user manual.
- For hygienic reasons, the appliance should only be used by one person.
- Never use compressed air, scouring pads, abrasive cleaning agents or aggressive liquids such as petrol or acetone to clean the appliance.

- If your shaver comes with a cleaning system, always use the original Philips cleaning fluid (cartridge or bottle, depending on the type of cleaning system).
- Always place the cleaning system on a stable, level and horizontal surface to prevent leakage.
- If your cleaning system uses a cleaning cartridge, always make sure the cartridge compartment is closed before you use the cleaning system to clean or charge the shaver.
- When the cleaning system is ready for use, do not move it to prevent leakage of cleaning fluid.
- Water may drip from the socket at the bottom of the shaver when you rinse it. This is normal and not dangerous because all electronics are enclosed in a sealed power unit inside the shaver.
- Do not use the supply unit in or near wall sockets that contain an electric air freshener to prevent irreparable damage to the supply unit.

Electromagnetic fields (EMF)

- This Philips appliance complies with all applicable standards and regulations regarding exposure to electromagnetic fields.

General



- This shaver is waterproof. It is suitable for use in the bath or shower and for cleaning under the tap. For safety reasons, the shaver can therefore only be used without cord.
- The appliance is suitable for mains voltages ranging from 100 to 240 volts.
- The supply unit transforms 100-240 volts to a safe low voltage of less than 24 volts.

The display

Note: Remove any sticker or protective foil from the display before using the product.

Charging

Note: If you press the on/off button during charging, the 'unplug for use' symbol flashes white to remind you that you have to disconnect the product from the wall outlet.

Quick charge: When the battery is empty and you connect the product to an electrical outlet, the lights of the battery charge indicator light up one after the other repeatedly. When the product contains enough energy for one shave, the bottom light of the battery charge indicator starts flashing slowly.

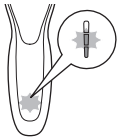

While the product continues to charge, first the bottom light of the battery charge indicator flashes and then lights up continuously. Then the second light flashes and then lights up continuously, and so on until the product is fully charged.

Battery fully charged

Note: This product can only be used without a cord.



When the battery is fully charged, all lights of the the battery charge indicator light up white continuously.

Note: When the battery is full, the display switches off automatically after 30 minutes.

Remaining battery charge



The remaining battery charge is shown by the lights of the battery charge indicator that light up continuously.

Battery low

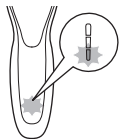

When the battery is almost empty, the bottom light of the battery charge indicator flashes orange.

'Unplug for use' reminder

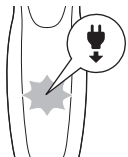

The 'unplug for use' symbol flashes to remind you that you have to disconnect the product from the power outlet before you can switch it on.

Cleaning reminder

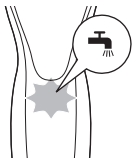

Clean the shaver after every shave for optimal performance. When you switch off the product, the cleaning reminder flashes to remind you to clean the product.

Travel lock

You can lock the appliance when you are going to travel. The travel lock prevents the appliance from being switched on by accident.

Activating the travel lock



- 1 Press the on/off button for 3 seconds to enter the travel lock mode.

While you activate the travel lock, the travel lock symbol lights up continuously. When the travel lock is activated, the travel lock symbol flashes.



Deactivating the travel lock

- 1 Press the on/off button for 3 seconds.
The travel lock symbol flashes and then lights up continuously. The appliance is now ready for use again.



Replacing shaving heads



For maximum shaving performance, replace the shaving heads every 2 years. The product is equipped with a replacement reminder which reminds you to replace the shaving heads. The shaving unit symbol lights up and the arrows flash to indicate that you have to replace the shaving heads.

Note: After replacing the shaving heads, you need to reset the replacement reminder by pressing the on/off button for 7 seconds.

Charge meter

Charge Meter monitors amount of remaining battery power available. Remaining battery capacity is based on the amount of power consumed shaving per minute and is dependent

upon your skin and beard type, whether you use pre-shave lotion, and how often the styler is used. Initially your shaver may need to go through 2 or 3 full charge/recharge cycles before remaining battery capacity indicators begin to display your accurate battery power left.

Charging

Charge the shaver before you use it for the first time and when the display indicates that the battery is almost empty.

Charging takes approx. 1 hour. A fully charged shaver has a shaving time of up to 50 minutes.

Note: You cannot use the appliance while it is charging.

Charging with the supply unit

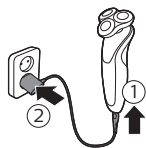

- 1 Make sure the appliance is switched off.
- 2 Put the small plug in the appliance and put the supply unit in the wall socket.
- 3 After charging, remove the supply unit from the wall socket and pull the small plug out of the appliance.

Using the appliance

Note: This appliance can only be used without cord.

Switching the appliance on and off



- 1 To switch on the appliance, press the on/off button once.
- 2 To switch off the appliance, press the on/off button once.

Shaving

Skin adaptation period

Your first shaves may not bring you the result you expect and your skin may even become slightly irritated. This is normal. Your skin and beard need time to adapt to any new shaving system. To allow your skin to adapt to this new appliance, we advise you to shave regularly (at least 3 times a week) and exclusively with this appliance for a period of 3 weeks.

Dry shaving

- 1 Switch on the appliance.
- 2 Move the shaving heads over your skin in circular movements to catch all hairs growing in different directions. Exert gentle pressure for a close, comfortable shave.

Note: Do not press too hard, this can cause skin irritation.

- 3 Clean the appliance after use.

Wet shaving

For a more comfortable shave, you can also use this appliance on a wet face with shaving foam or shaving gel.

To shave with shaving foam or shaving gel, follow the steps below:

- 1 Apply some water to your skin.



14 English



- 2 Apply shaving foam or shaving gel to your skin.



- 3 Rinse the shaving unit under the tap to ensure that the shaving unit glides smoothly over your skin.

- 4 Switch on the appliance.



- 5 Move the shaving heads over your skin in circular movements to catch all hairs growing in different directions. Exert gentle pressure for a close, comfortable shave.

Note: Do not press too hard, this can cause skin irritation.

Note: Rinse the shaving unit regularly to ensure that it continues to glide smoothly over your skin.

- 6 Dry your face.

- 7 Clean the appliance after use.

Note: Make sure you rinse all foam or shaving gel off the appliance.

Using the click-on attachments

Note: The accessories supplied may vary for different products. The box shows the accessories that have been supplied with your appliance.

Removing or attaching the click-on attachments

- 1 Make sure the appliance is switched off.



- 2 Pull the attachment straight off the appliance.

Note: Do not twist the attachment while you pull it off the appliance.



- 3 Insert the lug of the attachment into the slot in the top of the appliance. Then press down the attachment to attach it to the appliance ('click').

Note: Attach the click-on cleansing brush attachment on the attachment base first, before placing it on the appliance.

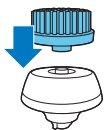

Using the cleansing brush attachment

Note: For better shaving results, use the click-on cleansing brush attachment before shaving.

Use the rotating cleansing brush with your daily cleansing cream. The cleansing brush removes oil and dirt, contributing to a healthy and oil-free skin. We advise you to use it no more than twice a day. Start with the lowest personal comfort setting to familiarize yourself with the attachment.

Do not use the appliance on damaged or irritated skin or on wounds.

- 1 Place the attachment on the attachment base.
- 2 Attach the attachment to the appliance ('click').

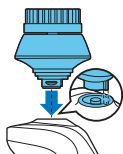

16 English



- 3** Moisten the attachment with water.

Note: Do not use the appliance with a dry brush attachment, as this can irritate the skin.



- 4** Moisten your face with water and apply a cleanser to your face.

- 5** Place the attachment on your cheek.

- 6** Switch on the appliance.



- 7** Gently move the attachment across your skin from the nose towards the ear. Do not push the attachment too hard onto the skin to make sure the treatment remains comfortable.

Note: Do not cleanse the sensitive area around your eyes.

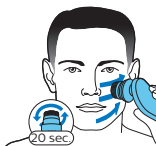

- 8** After approx. 20 seconds, move the appliance to your other cheek and start cleansing this part of your face.



- 9** After approx. 20 seconds move the appliance to your forehead and start cleansing this part of your face. Gently move the brush head from left to right.

Note: We advise you to not overdo the cleansing and to not cleanse any zone longer than 20 seconds.



10 After the treatment, rinse and dry your face. Your face is now ready for the next step of your daily skincare routine.

11 Clean the attachment after use (see 'Cleaning and maintenance').

Using the beard styler attachment with comb

You can use the beard styler with the comb attached to style your beard at one fixed setting, but also at different length settings. You can also use it to pre-trim any long hairs before shaving for a more comfortable shave.

The length settings on the beard styler attachment correspond to the remaining hair length after cutting and range from 1 to 5mm.

1 Attach the attachment to the appliance ('click').



2 Slide the comb straight into the guiding grooves on both sides of the beard styler ('click').



3 Press the length selector and then push it to the left or right to select the desired hair length setting.

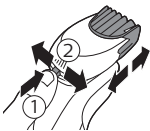

4 Switch on the appliance.



- 5 Move the appliance upwards while you exert gentle pressure. Make sure the front of the comb is in full contact with the skin.
- 6 Clean the attachment after use (see 'Cleaning and maintenance').

Using the beard styler attachment without comb

You can use the beard styler attachment without the comb to contour your beard, moustache, sideburns or neckline to a length of 0.5mm.

- 1 Pull the comb off the beard styler.

Note: Grab the comb in the center to pull it off the beard styler. Do not pull at the sides of the comb.

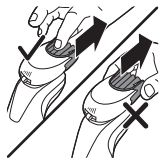

- 2 Switch on the appliance.



- 3 Hold the beard styler attachment perpendicular to the skin and move the appliance downwards while you exert gentle pressure.
- 4 Clean the attachment after use (see 'Cleaning and maintenance').

Cleaning and maintenance

Note: The accessories supplied may vary for different products. The box shows the accessories that have been supplied with your appliance.

Cleaning the shaver under the tap

Clean the shaver after every shave for optimal performance.

Be careful with hot water. Always check if the water is not too hot, to prevent burning your hands.

Never dry the shaving unit with a towel or tissue, as this may damage the shaving heads.

- 1 Switch on the appliance.
- 2 Rinse the shaving unit under a warm tap.



- 3 Switch off the appliance. Pull the shaving head holder off the bottom part of the shaving unit.

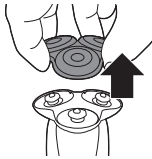

- 4 Rinse the hair chamber under the tap.



- 5 Rinse the shaving head holder under a warm tap.



- 6 Carefully shake off excess water and let the shaving head holder air dry.

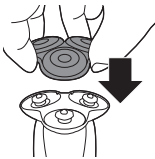

- 7 Attach the shaving head holder to the bottom part of the shaving unit ('click').

Cleaning the click-on attachments

Never dry trimmer or beard styler attachments with a towel or tissue, as this may damage the trimming teeth.

The accessories supplied may vary for different products. The box shows the accessories that have been supplied with your appliance.

Cleaning the cleansing brush attachment

Clean the cleansing brush attachment every time you have used it.

- 1 Switch off the appliance.
- 2 Detach the brush head from the attachment base.
- 3 Clean the parts thoroughly with warm water and soap.
- 4 Dry the cleansing brush attachment with a towel.

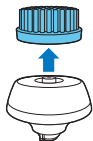

Cleaning the beard styler attachment

Clean the beard styler after each use.

- 1 Pull the comb off the beard styler.

Note: Grab the comb in the center to pull it off the beard styler. Do not pull at the sides of the comb.

- 2 Switch on the appliance.

- 3 Rinse the beard styler and the comb separately under a warm tap.
- 4 After cleaning, switch off the appliance.
- 5 Carefully shake off excess water and let the beard styler and comb air dry.

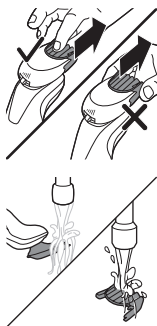

- 6 For optimal performance, lubricate the teeth of the attachment with a drop of sewing machine oil regularly.

Replacement

Replacing the shaving heads



For maximum shaving performance, we advise you to replace the shaving heads every two years. Replace damaged shaving heads immediately. Always replace the shaving heads with original Philips shaving heads (see 'Ordering accessories').

Replacement reminder



The replacement reminder indicates that the shaving heads need to be replaced. The shaving unit symbol and arrows light up when you switch off the appliance.

- 1 Switch off the appliance.

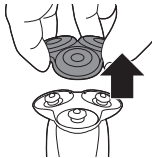

- 2 Pull the shaving head holder off the bottom part of the shaving unit.



- 3 Turn the retaining rings anticlockwise and remove them. Place them aside in a safe place.

22 English



- 4** Remove the shaving heads from the shaving head holder.

Discard the used shaving heads immediately to avoid mixing them with the new shaving heads.

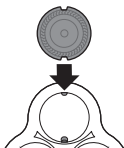

- 5** Place the new shaving heads in the shaving head holder.

Note: Make sure the notches on both sides of the shaving heads fit exactly onto the projections in the shaving head holder.

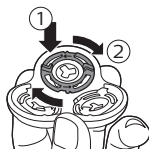

- 6** Place the retaining rings back onto the shaving heads and turn them clockwise to reattach the retaining ring.

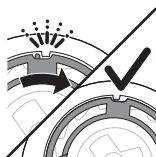

- Each retaining ring has two recesses that fit exactly into the projections of the shaving head holder. Turn the ring clockwise until you hear a click to indicate that the ring is fixed.

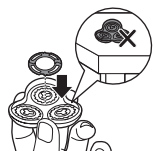

Note: Hold the shaving head holder in your hand when you reinsert the shaving heads and reattach the retaining rings. Do not place the shaving head holder on a surface, as this may cause damage to the shaving heads.

- 7** Attach the shaving head holder to the bottom part of the shaving unit ('click').
- 8** To reset the replacement reminder, press and hold the on/off button for approx. 7 seconds.

Storage

Storage



- Store the appliance in the pouch supplied.

Note: Make sure the appliance is dry before you store it in the pouch.



- Put the protection cap on the cleansing brush attachment to protect it from dirt accumulation.

Ordering accessories

To buy accessories or spare parts, visit **www.shop.philips.com/service** or go to your Philips dealer. You can also contact the Philips Consumer Care Center in your country (see the international warranty leaflet for contact details).

The following accessories and spare parts are available:

- SH70 Philips shaving heads
- HQ110 Philips shaving head cleaning spray
- RQ111 Philips beard styler attachment
- RQ585 Philips cleansing brush attachment
- MS591 Philips cleansing brush head (sensitive)
- RQ560/RQ563 Philips cleansing brush heads (normal)
- JC302/JC305 cleaning cartridge
- HQ8505 supply unit

Note: The availability of the accessories may differ by country.

Recycling

- Do not throw away the product with the normal household waste at the end of its life, but hand it in at an official collection point for recycling. By doing this, you help to preserve the environment.
- This product contains a built-in rechargeable battery which shall not be disposed of with normal household waste. We strongly advise you to take your product to an official collection point or a Philips service centre to have a professional remove the rechargeable battery.
- Follow your country's rules for the separate collection of electrical and electronic products and rechargeable batteries. Correct disposal helps prevent negative consequences for the environment and human health.

Removing the rechargeable appliance battery

Only remove the rechargeable battery when you discard the appliance. Before you remove the battery, make sure that the appliance is disconnected from the mains and that the battery is completely empty.

Take any necessary safety precautions when you handle tools to open the appliance.

Be careful, the battery strips are sharp.

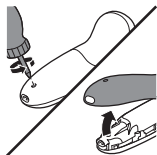

- 1 Remove the screw in the back panel with a screwdriver. Then remove the back panel.

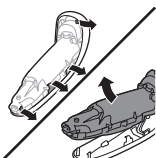

- 2 Bend the hooks aside and remove the power unit.

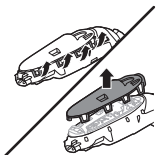

- 3 Break the snap hooks and remove the front panel of the power unit.

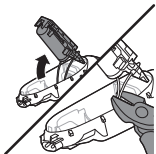

- 4 Take out the battery holder and cut the battery tags with a pair of cutting pliers.

Warranty and support

If you need information or support, please visit www.philips.com/support or read the international warranty leaflet.

Warranty restrictions

The shaving heads (cutters and guards) are not covered by the terms of the international warranty because they are subject to wear.

Troubleshooting

This chapter summarizes the most common problems you could encounter with the appliance. If you are unable to solve the problem with the information below, visit www.philips.com/support for a list of frequently asked questions or contact the Consumer Care Center in your country.

Shaver

Problem	Possible cause	Solution
The appliance does not work when I press the on/off button.	The appliance is still attached to the wall socket. For safety reasons, the appliance can only be used without cord.	Unplug the appliance and press the on/off button to switch on the appliance.
	The rechargeable battery is empty.	Recharge the battery (see 'Charging').
	The travel lock is activated.	Press the on/off button for 3 seconds to deactivate the travel lock.
	The shaving unit is soiled or damaged to such an extent that the motor cannot run.	Clean the shaving heads thoroughly or replace them. Also see 'Hairs or dirt obstruct the shaving heads' for a detailed description of how to clean the shaving heads thoroughly.
The appliance does not shave as well as it used to.	The shaving heads are damaged or worn.	Replace the shaving heads (see 'Replacement').
	Hairs or dirt obstruct the shaving heads.	Clean the shaving heads in the regular way or clean them thoroughly.

Problem	Possible cause	Solution
		To clean the shaving heads thoroughly, remove the shaving heads from the shaving head holder one by one (see 'Replacement'). Then separate the cutter from its guard and rinse each matching set under the tap. After rinsing, place the cutter back into its corresponding guard. Finally, put the shaving heads back into the shaving head holder (see 'Replacement').
I replaced the shaving heads, but the replacement reminder is still showing.	You have not reset the appliance.	Reset the appliance by pressing the on/off button for approx. 7 seconds.
A shaving head symbol has suddenly appeared on the display.	This symbol is a replacement reminder.	Replace the shaving heads (see 'Replacement').
Water is leaking from the bottom of the appliance.	During cleaning, water may collect between the inner body and the outer shell of the appliance.	This is normal and not dangerous because all electronics are enclosed in a sealed power unit inside the appliance.

简介

感谢您的惠顾，欢迎光临飞利浦！为了让您能充分享受飞利浦提供的支持，请在 www.philips.com/welcome 上注册您的产品。

基本说明

- 1 胡须造型器修剪梳
- 2 卡入式胡须造型器附件
- 3 卡入式剃须刀头部件
- 4 开/关按钮
- 5 小插头插座
- 6 电池充电指示灯（3级指示）
- 7 “拔出插头即可使用”符号
- 8 旅行锁符号
- 9 更换提醒
- 10 清洗提示
- 11 洁面刷保护盖
- 12 卡入式洁面刷附件
- 13 附件基座
- 14 电源部件
- 15 小插头
- 16 小软袋
- 17 大软袋

危险



- 保持电源部件干燥。
- 警告符号注释：禁止在打开的水龙头下进行清洗。

警告

- 要给电池充电，请仅使用产品随附的可拆卸电源部件 (HQ80)。
- 电源部件中包含一个变压器。请勿自行更换电源部件的插头，否则将导致严重后果。

- 本产品也可以由 8 岁或以上年龄的儿童以及肢体不健全、感觉或精神上有障碍或缺乏相关经验和知识的人士使用，但前提是有人对他们使用本产品进行监督或指导，以确保他们安全使用，并且让他们明白相关的危害。切勿让儿童玩弄本产品。不要让儿童在无人监督的情况下对本产品进行清洁和保养。
- 将剃须刀手持部分与电源软线分开后，才能在水龙头下清洗手持部分。
- 使用前，请务必检查产品。请勿使用损坏的产品，否则可能对人体造成伤害。请务必用原装型号更换损坏的部件。
- 切勿拆开本产品更换充电电池。

警告



- 切勿将清洁系统或充电座浸入水中，也不要在水龙头下冲洗。
- 警告符号注释：禁止在打开的水龙头下进行清洗
- 切勿使用温度高于 60° C 的热水冲洗剃须刀。
- 只能将本产品用于用户手册中所示的原定用途。
- 出于卫生的目的，本产品只能供一个人使用。
- 切勿使用压缩气体、钢丝绒、研磨性清洁剂或腐蚀性液体（例如汽油或丙酮）来清洁产品。
- 如果剃须刀随附清洁系统，应始终使用原装飞利浦清洁液（滤芯或瓶，取决于清洁系统类型）。
- 清洁系统必须放在稳定、平坦的水平表面上，以防漏液。
- 如果清洁系统采用清洁滤芯，在使用清洁系统进行清洁或为剃须刀充电之前，应始终确保滤芯仓已关闭。
- 清洁系统准备就绪时，切勿移动，以免清洁液漏出。
- 冲洗剃须刀时，水可能从产品底部的插口漏出。这是正常的，而且没有危险，因为所有电子元件都封闭在剃须刀内部的密封电源部件中。
- 请勿在包含电动空气清新器的墙壁插座上或其周围使用电源部件，以免电源部件受到不可修复的损坏。

电磁场 (EMF)

- 本 Philips 产品符合所有有关暴露于电磁场的适用标准和法规。

概述



- 符号注释：适合于在洗澡或淋浴时使用。允许在盛水的浴缸、淋浴、洗脸盆或其他器皿附近使用本器具。
- 该剃须刀具有防水性能。适合在沐浴或淋浴时使用，也可以放在水龙头下清洗。出于安全原因，该剃须刀在使用时不能连接电线。
- 本产品适合在 100 - 240 伏的电源电压下工作。
- 该电源部件可将 100-240 伏的电压转换为 24 伏以下的安全低电压。

显示屏

注意：使用本产品前，请先取下显示屏上的任何不干胶标签或保护膜。

充电

注意：充电期间按开/关按钮，“拔出插头即可使用”符号会呈白色闪烁，提醒您需断开本产品与电源插座的连接。

快速充电：电池电量耗尽后，当您本产品连接到电源插座时，电池充电指示灯将逐个亮起并重复循环。当本产品包含的电量足够完成一次剃须时，底部的电池充电指示灯开始缓慢闪烁。

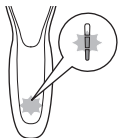

如果继续充电，本产品底部的电池充电指示灯先是闪烁，然后持续亮起。然后，第二个指示灯闪烁，之后持续亮起，以此类推，直至本产品充满电。

电池已完全充满

注意：本产品只能在不接电源的情况下使用。



电池已完全充满

电池充满电后，所有电池充电指示灯都将呈白色持续亮起。

注意： 电池充满电后，显示屏会在 30 分钟后自动关闭。

电池剩余电量



电池充电指示灯

剩余的电池电量由持续亮起的充电指示灯来表示。

电池电量不足

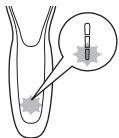

当电池电量几乎耗尽时，电池充电指示灯的底灯会呈橙色闪烁。

“拔出插头即可使用”提醒

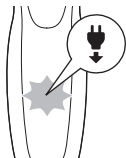

“拔出插头即可使用”符号闪烁，提醒您需先断开产品与电源插座的连接才能启动本产品。

清洗提示



每次剃须后请清洁剃须刀，以获得出色性能。关闭本产品时，清洗提示符号闪烁，提醒您需要清洁产品。

旅行锁

您可以在携带本产品旅行之前将其锁住。旅行锁可防止本产品被意外启动。

启用旅行锁

- 1 按住开/关按钮 3 秒钟以进入旅行锁模式。



启用旅行锁后，旅行锁符号会持续亮起。旅行锁启用后，旅行锁符号将闪烁。

禁用旅行锁

- 1 按开/关按钮 3 秒钟。



旅行锁符号闪烁，然后持续亮起。现在可以再次使用本产品。



更换剃须刀头



要获得最佳的剃须效果，请每两年更换一次剃须刀头。本产品配有更换提示，它会提醒您更换剃须刀头。剃须刀头部件符号亮起，箭头闪烁，表示需要更换剃须刀头。

注意：更换剃须刀头后，您需要通过按开/关按钮 7 秒来重置更换提醒。

电量指示器

电量指示器负责监控可用的剩余电池电量。剩余电池容量基于剃须时每分钟消耗的电量而定，并取决于您的皮肤和胡须类型、剃须前是否使用了剃须乳液以及造型器的使用频率。

开始时，您的剃须刀可能需要先经过 2 到 3 次的充满电/放电周期，然后剩余电池容量指示灯才开始显示准确的剩余电池电量。

充电

首次使用剃须刀之前，或当显示屏指示电池电量几乎耗尽时，请先为剃须刀充电。

充电约需 1 小时。充满电的剃须刀最长剃须时间 可达 50 分钟。

注意：不能在充电时使用本产品。

用电源部件充电

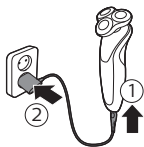

- 1 确保产品电源已关闭。
- 2 将小插头插入本产品，然后将电源部件插入电源插座。
- 3 充电之后，从电源插座上拔下电源部件，并从产品上拔下小插头。

使用本产品

注意：本产品只能在不接电源的情况下使用。

打开或关闭产品



- 1 要打开本产品，请按一下开/关按钮。
- 2 要关闭产品，请按一下开/关按钮。

剃须

皮肤适应期

前几次剃须可能不会带给您预期效果，并且您的皮肤可能会受到轻度刺激。这是正常的。您的皮肤和胡须需要时间适应任何新的剃须系统。为了让您的皮肤适应这款新产品，我们建议您在 3 周时间内定期（至少每周 3 次）仅使用本产品剃须。

干用剃须

- 1 启动产品。
- 2 让剃须刀头在您的皮肤上作迂回运动，以刮剃向不同方向生长的所有须发。轻轻按压，以获取舒适贴面的剃须感受。

注意：划圈动作比直线动作的剃须效果更好。

- 3 使用后要清洁本产品。

湿剃

要获得更舒适的剃须体验，您也可以先用剃须泡沫或剃须啫喱将脸弄湿，然后再用本产品进行剃须。

要用剃须泡沫或剃须啫喱剃须，请按照下面的步骤执行操作：

- 1 用水润湿皮肤。





2 在皮肤上涂抹剃须泡沫或剃须啫喱。



3 在水龙头下冲洗一下剃须刀头部件，确保剃须刀头部件可以在您的皮肤上顺畅滑动。

4 启动产品。



5 让剃须刀头在您的皮肤上作迂回运动，以刮剃向不同方向生长的所有须发。轻轻按压，以获取舒适贴面的剃须感受。

注意： 定期冲洗剃须刀头部件，确保其能够继续在您的皮肤上顺畅滑动。

6 擦干面部。

7 使用后要清洁本产品。

注意： 确保冲洗干净本产品上的所有泡沫或剃须啫喱。

使用卡入式附件

注意： 随附的附件可能因产品而异。包装盒上会显示随附于您产品的附件。

拆卸或安装卡入式附件

1 确保产品电源已关闭。

2 将附件竖直抽离产品。

注意： 将附件从产品上抽出时，不要旋转。



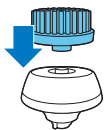

- 3 将附件的凸缘插入本产品顶部的槽内。然后，按下附件将其安装到本产品上（可听到“咔哒”一声）。

注意：请先将卡入式洁面刷附件安装到附件基座上，然后再安装到本产品上。

使用洁面刷附件

注意：为获得最佳的剃须效果，剃须之前使用卡入式洁面刷附件进行清洁。

将旋转洁面刷与日常洁面产品一起使用。洁面刷可去除油脂和污垢，焕发健康无油脂的肌肤。建议每天使用本产品不超过2次。从最低个人舒适度设置开始，以熟悉附件的使用方法。

请不要在受伤或发炎的皮肤或伤口上使用本产品。



- 1 将附件安装至附件基座上。
- 2 将附件安装到产品上（可听到“咔哒”一声）。

- 3 用水湿润附件。

注意：切勿在洁面刷附件干燥的情况下使用产品，否则可能会刺激皮肤。



- 4 用水润湿面部，并将洁面乳涂抹到脸上。
- 5 将附件置于面颊上。
- 6 启动产品。

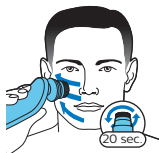

- 7 在鼻子至耳朵之间的皮肤上轻轻地移动附件。请勿过分用力地将附件压在皮肤上，以确保舒适护理。

注意：切勿清洁眼部周围的敏感区域。



- 8 约 20 秒后，可将本产品移至另一侧面颊，开始清洁这部分面部皮肤。

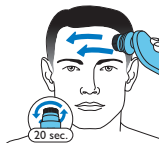

- 9 约 20 秒后，可将本产品移至前额，开始清洁这部分面部皮肤。轻轻将刷头从左向右移动。

注意：建议您不要过度清洁，任何部位的清洁时间不要超过 20 秒钟。



- 10 护理后，洗脸并擦干。现在您可以进行日常面部护肤的下一步了。

- 11 使用 (请参见 '清洁和保养')后要清洁附件。

使用带修剪梳的胡须造型器附件

您可以使用带修剪梳的胡须造型器以固定设置（也可使用不同的长度设置）修整胡须。您也可以在剃须前用其预先修剪较长须发，以实现更舒适的剃须体验。

胡须造型器附件的长度设置对应修剪后剩余的须发长度，范围为 1 到 5 毫米。

- 1 将附件安装到产品上（可听到“咔哒”一声）。





- 2 将修剪梳直接滑入胡须造型器两侧的导槽中（可听到“咔哒”一声）。

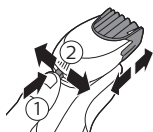

- 3 按下长度选择器，然后将其向左或向右推动以选择所需的须发长度设置。
- 4 启动产品。



- 5 向上移动产品，同时轻轻按压。确保修剪梳的正面与皮肤完全接触。

- 6 使用 (请参见 '清洁和保养')后要清洁附件。

使用不带修剪梳的胡须造型器附件

您可以使用不带修剪梳的胡须造型器附件将胡须、须髥、鬓角或颈部轮廓修整至 0.5 毫米的长度。

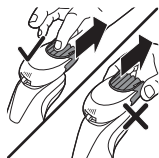

- 1 将修剪梳抽离胡须造型器。

注意： 抓住修剪梳的中心位置，将其抽离胡须造型器。不要拉拔修剪梳的侧面。

- 2 启动产品。



- 3 将胡须造型器附件垂直放在皮肤上，向下移动产品，同时轻轻按压。

- 4 使用 (请参见 '清洁和保养')后要清洁附件。

清洁和保养

注意： 随附的附件可能因产品而异。包装盒上会显示随附于您产品的附件。

在水龙头下冲洗剃须刀

每次剃须后请清洁剃须刀，以获得出色性能。

使用热水要当心。切记先检查水温是否太高，以防烫手。

不要用毛巾或纸巾擦拭剃须刀头部件，因为这样可能会损坏剃须刀头。

- 1 启动产品。
- 2 用温水冲洗剃须刀头部件。



- 3 关闭产品。将剃须刀头支架从剃须刀头部件的底部抽离。

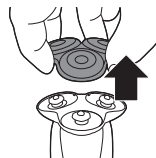

- 4 在水龙头下冲洗胡茬储藏室。



- 5 用温水冲洗剃须刀头支架。
- 6 小心甩干多余的水，然后让剃须刀头支架晾干。



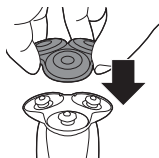

- 3 将剃须刀头支架安装到剃须刀头部件的底部（可听到“咔哒”一声）。

清洁卡入式附件

切勿用毛巾或纸巾擦干修剪器或胡须造型器附件，这样做可能会损坏修剪齿。

随附的附件可能因产品而异。包装盒上会显示随附于您产品的附件。

清洗洁面刷附件

每次使用后都要清洗洁面刷附件。

- 1 关闭产品。
- 2 从附件基座上卸下刷头。
- 3 用温水和肥皂彻底清洗部件。
- 4 用毛巾擦干洁面刷附件。

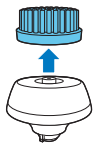

清洁胡须造型器附件

每次使用后都要清洁胡须造型器。

- 1 将修剪梳抽离胡须造型器。

注意：抓住修剪梳的中心位置，将其抽离胡须造型器。不要拉拔修剪梳的侧面。

- 2 启动产品。

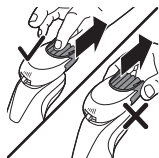

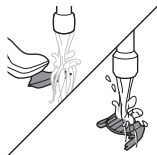

- 3 在温水水龙头下单独冲洗胡须造型器和修剪梳。
- 4 清洁完成后，关闭产品。
- 5 小心地甩干多余的水，然后将胡须造型器和修剪梳晾干。
- 6 为获得最佳效果，请定期用一滴缝纫机油润滑附件齿部。

更换

更换剃须刀头



为获得更好剃须效果，建议每两年更换一次剃须刀头。立即更换损坏的剃须刀头。务必使用原装飞利浦剃须刀头 (请参见 '订购配件') 进行更换。

更换提醒

更换提醒表示需要更换剃须刀头。关闭产品时，剃须刀头部件符号和箭头亮起。

- 1 关闭产品。

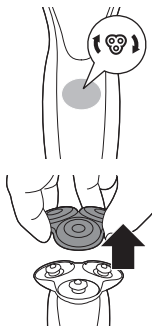

- 2 将剃须刀头支架从剃须刀头部件的底部抽离。

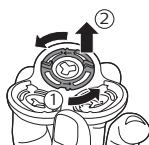

- 3 逆时针旋转固定环并将其取下。将其存放在安全的地方。



- 4 从剃须刀头支架上卸下剃须刀头。

立即丢弃用过的剃须刀头，以免与新的剃须刀头混淆。

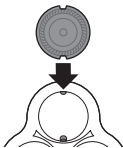

- 5 将新的剃须刀头装到剃须刀头支架中。

注意：确保剃须刀头两侧的槽口正好卡入剃须刀头支架上的凸起部位。

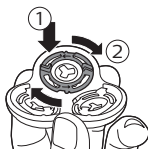

- 6 将固定环放回剃须刀头上，然后顺时针旋转以重新安装固定环。

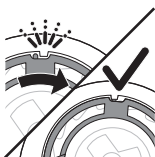

- 每个固定环均具有两个凹槽，正好能够装入剃须刀头支架的凸缘上。顺时针旋转固定环，直至听到“咔哒”一声，表明固定环已就位。

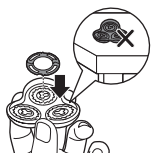

注意：当您重新插入剃须刀头并重新安装固定环时，请将剃须刀头支架握在手中。切勿将剃须刀头支架放在平面上，否则可能会损坏剃须刀头。

- 7 将剃须刀头支架安装到剃须刀头部件的底部（可听到“咔哒”一声）。
- 8 要重置更换提醒，请按住开/关按钮约 7 秒钟。

存放

存放



- 将产品存放在随附的软袋中。

注意：将本产品存放到软袋之前，应确保其干燥。



- 将保护盖放在洁面刷附件上，以防产品积聚灰尘。

订购配件

要购买附件或备件，请访问 www.shop.philips.com/service 或联系您的飞利浦经销商。您还可以联系所在国家/地区的飞利浦客户服务中心（请参阅全球保修卡了解详细联系信息）。

可选配以下附件和备件：

- SH70 飞利浦剃须刀头
- HQ110 飞利浦剃须刀头清洁喷雾剂
- RQ111 飞利浦胡须造型器附件
- RQ585 飞利浦洁面刷附件
- MS591 飞利浦洁面刷头（敏感肌肤）
- RQ560/RQ563 飞利浦洁面刷头（普通肌肤）
- JC302/JC305 清洁滤芯
- HQ8505 电源部件

注意：配件可用性可能因国家/地区而异。

回收

- 弃置本产品时，请不要将其与一般生活垃圾放在一起，应将其交给政府指定的回收中心。这样做将有利于环保。
- 此产品包含内置充电电池；请勿将充电电池与一般生活垃圾一起弃置。强烈建议您将自己的产品送到官方收集点或飞利浦服务中心，让专业人士移除充电电池。
- 遵循您的国家/地区有关分类回收电子电气产品和充电电池的规定。正确弃置产品有助于避免对环境和人类健康造成不良后果。

取出可充电的产品电池

仅在丢弃本产品时方可取出充电电池。卸下电池之前，请确保本产品与电源断开连接并且电池电量已耗尽。

当您使用工具打开本产品时，请采取必要的安全保护措施。

注意，电池带非常锋利。

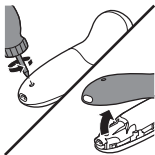

- 1 使用螺丝刀取出后面板中的螺钉。拆除后面板。

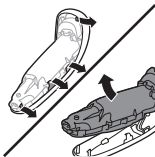

- 2 将钩子向外掰，取出电源部件。

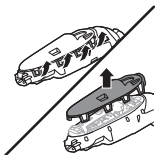

3 脱离安全钩，取下电源部件的前面板。

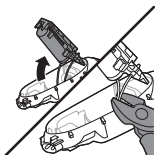

4 取出电池舱，用一把钢丝钳剪下电池标签。

部件名称	产品中有害物质的名称及含量					
	有害物质					
	铅 (Pb)	汞 (Hg)	镉 (Cd)	六价铬 (Cr (VI))	多溴联苯 (PBB)	多溴二苯醚 (PBDE)
PCB's 集成电路板	X	○	○	○	○	○
Electrical contact pins 电接触片	X	○	○	○	○	○
Power plug 电源插头	X	○	○	○	○	○
Internal metal parts 内部金属件	X	○	○	○	○	○

本表格依据SJ/T 11364的规定编制。

○: 表示该有害物质在该部件所有均质材料中的含量均在GB/T 26572规定的限量要求以下。

X: 表示该有害物质至少在该部件的某一均质材料中的含量超出GB/T 26572规定的限量要求。

- 该表格中所显示的“有害物质”在产品正常使用情况下不会对人身和环境产生任何伤害。
- 该表格中所显示的“有害物质”及其存在的部件向消费者和回收处理从业者提供相关物质的存在信息，有助于产品废弃时的妥善处理。

保修和支持

如需信息或支持，请访问 www.philips.com/support 或阅读国际保修卡。

保修条款

由于剃须刀头（刀片和网罩）属于易磨损物品，因此不在国际保修条款的涵盖范围之列。

故障种类和处理方法

本章归纳了使用本产品时最常见的一些问题。如果您无法根据以下信息解决问题，请访问

www.philips.com/support 查阅常见问题列表，或联系您所在国家/地区的客户服务中心。

剃须刀

问题	可能的原因	解决方法
按下开/关按钮时，产品不工作。	本产品仍然连接着电源插座。出于安全原因，本产品在使用时不能连接电线。	拔掉本产品插头并按开/关按钮打开产品。
	充电电池的电量已耗尽。	给电池充电 (请参见 '充电')。
	旅行锁已被激活。	按住开/关按钮 3 秒钟以解除旅行锁。
	剃须刀头部件被污染或损坏，导致马达无法运行。	彻底清洁剃须刀头或将其更换。有关如何彻底清洗剃须刀头的详细说明，另请参阅“毛发或污垢堵塞了剃须刀头”。
产品的剃须效果没有以前好。	剃须刀头已损坏或磨损。	更换剃须刀头 (请参见 '更换')。
	毛发或污垢堵塞了剃须刀头。	对剃须刀头进行常规或彻底清洁。 要彻底清洁剃须刀头，请将剃须刀头从剃须刀头支架上逐一 (请参见 '更换') 卸下。然后，分离刀片和网罩，并在水龙头下冲洗每个刀片和网罩套装。冲洗后，将刀片放回对应的网罩中。最后，将剃须刀头装回到剃须刀头支架 (请参见 '更换') 中。
我更换了剃须刀头，但仍然显示更换提醒。	产品尚未重置。	按住开/关按钮大约 7 秒钟以重置产品。
显示屏上突然出现剃须刀头符号。	此符号是更换提醒。	更换剃须刀头 (请参见 '更换')。

问题	可能的原因	解决方法
水从本产品底部漏出。	在清洁过程中，水可能聚集在本产品的机身内部与外壳之间。	这是正常现象，而且没有危险，因为所有电子元件都封闭在本产品内部的密封电源部件中。

PHILIPS

产品： 飞利浦电动剃须刀
 型号： S7740
 额定电压： 220V~
 额定频率： 50Hz
 额定输入功率： 9 W
 产地： 荷兰
 生产日期： 请见产品本体



制造商：飞利浦电子香港有限公司
 香港新界沙田香港科学园科技道东五号

经销单位：飞利浦（中国）投资有限公司
 上海市天目西路218号1602-1605
 全国顾客服务热线：4008 800 008

本产品根据国标 GB4706.1-2005,
 GB4706.9-2008制造

保留备用

发行日期: 24/5/2017

— |

| —

— |

| —

— |

| —

— |

| —

— |

| —

— |

| —



© 2017 Koninklijke Philips N.V.

All rights reserved

保留所有权利

4222.002.7348.1 (24/5/2017)

> 75% 循环再造纸



>75% recycled paper

>75% papier recyclé