

PHILIPS

Series S5000

XZ5810, S5888,
S5580, S5571,
S5570, S5560,
S5551, S5530,
S5380, S5370

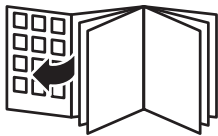



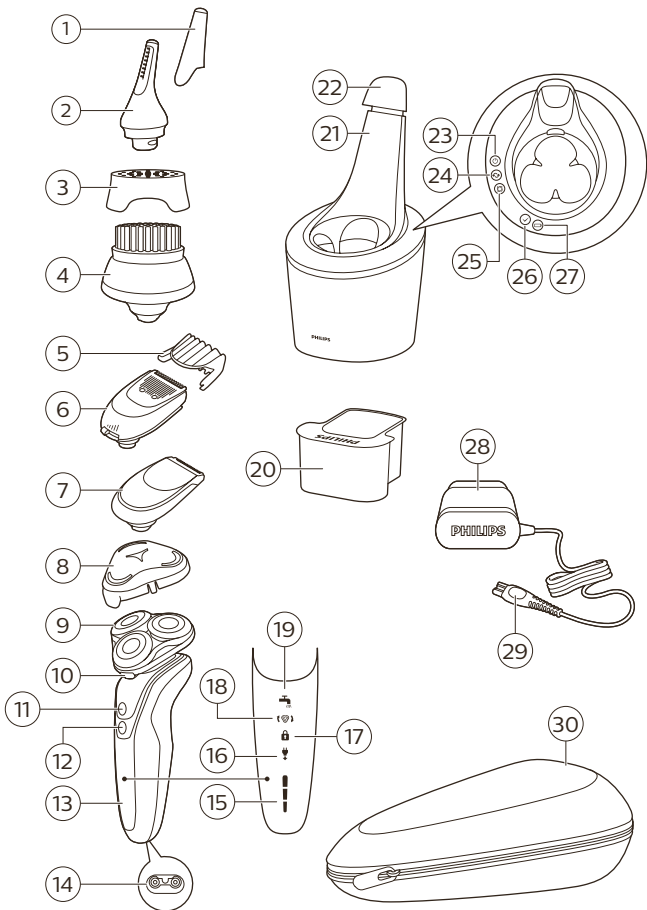

English 6
简体中文 **41**

General description

- 1 Protection cap for nose trimmer attachment (S5530/37 only)
- 2 Click-on nose trimmer attachment (S5530/37 only)
- 3 Protection cap for cleansing brush attachment (XZ5810/70, S5580/68, S5571/68, S5570/43, S5570/33, S5560/33 only)
- 4 Click-on cleansing brush attachment (XZ5810/70, S5580/68, S5571/68, S5570/43, S5570/33, S5560/33 only)
- 5 Comb for beard styler attachment (S5580/68, S5571/68, S5570/33, S5560/33 only)
- 6 Click-on beard styler attachment (S5580/68, S5571/68, S5570/33, S5560/33)
- 7 Click-on precision trimmer attachment (XZ5810/70, S5580/68, S5571/68, S5570/43, S5380/04, S5370/04, S5530/37 only)
- 8 Protection cap for shaving unit (XZ5810/70, S5888/75, S5380/04, S5370/04 only)
- 9 Click-on shaving unit
- 10 Shaving unit release button
- 11 On/off button
- 12 Turbo button
- 13 Handle
- 14 Socket for small plug
- 15 Battery charge indicator with 3 lights
- 16 Unplug for use symbol
- 17 Travel lock symbol
- 18 Replacement reminder
- 19 Cleaning reminder
- 20 Cleaning cartridge for SmartClean system (XZ5810/70, S5888/75, S5570/33, S5560/33, S5551/27, S5530/37 only)
- 21 SmartClean system (XZ5810/70, S5888/75, S5570/33, S5560/33, S5551/27, S5530/37 only)

- 22 Cap of SmartClean system (XZ5810/70, S5888/75, S5570/33, S5560/33, S5551/27, S5530/37 only)
- 23 On/off button
- 24 Replacement symbol
- 25 Rinsing symbol
- 26 Ready symbol
- 27 Battery symbol
- 28 Supply unit
- 29 Small plug
- 30 Pouch (XZ5810/70, S5570/43, S5570/33, S5560/33, S5530/37 only)

The accessories supplied may vary for different products. The box shows the accessories that have been supplied with your product.

Introduction

Congratulations on your purchase and welcome to Philips! To fully benefit from the support that Philips offers, register your product at www.philips.com/welcome.

Important safety information

Read this important information carefully before you use the appliance and its accessories and save it for future reference. The accessories supplied may vary for different products.

Danger



- Keep the supply unit dry.

Warning

- To charge the battery, only use the detachable supply unit (HQ8505) provided with the appliance.
- The supply unit contains a transformer. Do not cut off the supply unit to replace it with another plug, as this causes a hazardous situation.
- This appliance can be used by children aged from 8 years and above and persons with reduced physical, sensory or mental capabilities or lack of experience and knowledge if they have been given supervision or instruction concerning use of the appliance in a safe way and understand the hazards involved. Children shall not play with the appliance. Cleaning and user maintenance shall not be made by children without supervision.
- Always unplug the shaver before you clean it under the tap.
- Always check the appliance before you use it. Do not use the appliance if it is damaged, as this may cause injury. Always replace a damaged part with one of the original type.
- This appliance contains batteries that are non-replaceable.
- Do not open the appliance to replace the rechargeable battery.

Caution



- Never immerse the cleaning system or the charging stand in water and do not rinse it under the tap.
- Never use water hotter than 60°C to rinse the shaver.
- Only use this appliance for its intended purpose as shown in the user manual.
- For hygienic reasons, the appliance should only be used by one person.

- Never use compressed air, scouring pads, abrasive cleaning agents or aggressive liquids such as petrol or acetone to clean the appliance.
- If your shaver comes with a cleaning system, always use the original Philips cleaning fluid (cartridge or bottle, depending on the type of cleaning system).
- Always place the cleaning system on a stable, level and horizontal surface to prevent leakage.
- If your cleaning system uses a cleaning cartridge, always make sure the cartridge compartment is closed before you use the cleaning system to clean or charge the shaver.
- When the cleaning system is ready for use, do not move it to prevent leakage of cleaning fluid.
- Water may drip from the socket at the bottom of the shaver when you rinse it. This is normal and not dangerous because all electronics are enclosed in a sealed power unit inside the shaver.
- Do not use the supply unit in or near wall sockets that contain an electric air freshener to prevent irreparable damage to the supply unit.

Electromagnetic fields (EMF)

This Philips appliance complies with all applicable standards and regulations regarding exposure to electromagnetic fields.

General



- This shaver is waterproof. It is suitable for use in the bath or shower and for cleaning under the tap. For safety reasons, the shaver can therefore only be used without cord.
- The supply unit is suitable for mains voltages ranging from 100 to 240 volts.

- The supply unit transforms 100-240 volts to a safe low voltage of less than 24 volts.

The display

Battery charge indicator

Note: If you press the on/off button during charging, the 'unplug for use' symbol flashes white to remind you that you have to disconnect the appliance from the wall socket.

Quick charge: When the battery is empty and you connect the appliance to the wall socket, the lights of the battery charge indicator light up one after the other repeatedly. When the appliance contains enough energy for one shave, the bottom light of the battery charge indicator starts flashing slowly. While the appliance continues to charge, first the bottom light of the battery charge indicator flashes and then lights up continuously, and then the second light flashes and then lights up continuously, and so on until the appliance is fully charged.

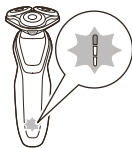

Battery fully charged

Note: When the battery is full, the display switches off automatically after 30 minutes.

Note: This appliance can only be used without cord.

When the battery is fully charged, all lights of the battery charge indicator light up white continuously.



Battery low



When the battery is almost empty, the bottom light of the battery charge indicator flashes orange. At this point there is enough energy left for one shave.

Remaining battery charge



The remaining battery charge is shown by the lights of the battery charge indicator that light up continuously.

'Unplug for use' reminder

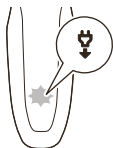

The 'unplug for use' symbol flashes to remind you that you have to disconnect the appliance from the wall socket before you can switch it on.

Cleaning reminder

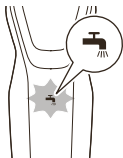

Clean the shaver after every use for optimal performance. When you switch off the appliance, the cleaning reminder flashes to remind you to clean the appliance.

Travel lock

When you are going to travel, you can lock the shaver to prevent it from accidentally switching on (see 'Activating the travel lock').

Activating the travel lock



- 1 Press the on/off button for 3 seconds to use the travel lock mode.



While you activate the travel lock, the travel lock symbol lights up continuously. When the travel lock is activated, the travel lock symbol flashes.

If you try to switch on the shaver while the travel lock is active, the travel lock symbol flashes.

Deactivating the travel lock

- 1 Press the on/off button for 3 seconds.

While you deactivate the travel lock, the travel lock symbol lights up briefly and the shaver produces a short sound. The shaver switches on and is now ready for use again.



Replacement reminder



For maximum shaving performance, we advise you to replace the shaving heads every two years. The appliance is equipped with a replacement reminder which reminds you to replace the shaving heads. The shaving unit symbol and arrows light up to indicate that you have to replace the shaving heads (see 'Replacing the shaving heads').

Note: After replacing the shaving heads, you can reset the replacement reminder by pressing the on/off button for 7 seconds. If you do not reset the replacement reminder, the shaver resets automatically after 9 shaves.

Turbo setting (specific types only)

The appliance is equipped with a Turbo or Turbo+ setting. This setting is intended for quicker and more intense shaving and makes hard-to-reach areas easier to shave.

Activating the Turbo setting

- 1 To activate the Turbo setting, press the Turbo button once when the appliance is switched on.

Deactivating the Turbo setting

- 1 To deactivate the Turbo setting, press the Turbo button once.

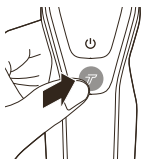

Charging

Charge the shaver before you use it for the first time and when the display indicates that the battery is almost empty.

Charging takes approx. 1 hour.

Note: You cannot use the appliance while it is charging.

Charging with the supply unit

- 1 Make sure the appliance is switched off.
- 2 Put the small plug in the appliance and put the supply unit in the wall socket.
- 3 After charging, remove the supply unit from the wall socket and pull the small plug out of the appliance.

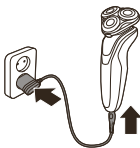

Note: When the battery is full, the display switches off automatically after 30 minutes.

Charging in the SmartClean system (specific types only)

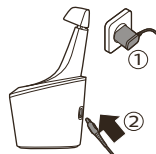

- 1 Put the small plug in the back of the SmartClean system.
- 2 Put the supply unit in the wall socket.

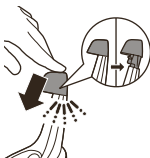

- 3 Press to open the SmartClean system cap, to be able to place the shaver in the holder ('click').

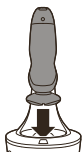

- 4 Hold the shaver upside down above the holder. Make sure the front of the shaver points towards the SmartClean system holder.

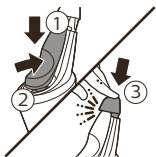

- 5 Place the shaver in the holder, tilt the shaver backwards and press down the SmartClean system cap to connect the shaver ('click').

The battery symbol flashes to indicate that the appliance is charging. When the battery is fully charged, the battery symbol lights up continuously.

Using the appliance

Note: This appliance can only be used without cord.

Switching the appliance on and off

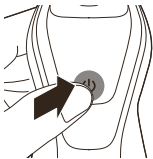

- 1 To switch on the appliance, press the on/off button once.
- 2 To switch off the appliance, press the on/off button once.

The display lights up for a few seconds to show the remaining battery status.

Shaving

Skin adaptation period

Your first shaves may not bring you the result you expect and your skin may even become slightly irritated. This is normal. Your skin and beard need time to adapt to any new shaving system. To allow your skin to adapt to this new appliance, we advise you to shave regularly (at least 3 times a week) and exclusively with this appliance for a period of 3 weeks.

Dry shaving

- 1 Switch on the appliance.
- 2 Move the shaving heads over your skin in circular movements to catch all hairs growing in different directions. Make sure each shaving head is fully in contact with the skin. Exert gentle pressure for a close, comfortable shave.

Note: Do not press too hard, as this can cause skin irritation.

- 3 Clean the appliance after use.

Wet shaving

For a more comfortable shave, you can also use this appliance on a wet face with shaving foam or shaving gel.

To shave with shaving foam or shaving gel, follow the steps below:





1 Apply some water to your skin.



2 Apply shaving foam or shaving gel to your skin.



3 Rinse the shaving unit under the tap to ensure that the shaving unit glides smoothly over your skin.

4 Switch on the appliance.



5 Move the shaving heads over your skin in circular movements to catch all hairs growing in different directions. Make sure each shaving head is fully in contact with the skin. Exert gentle pressure for a close, comfortable shave.

Note: Do not press too hard, this can cause skin irritation.

Note: Rinse the shaving unit regularly to ensure that it continues to glide smoothly over your skin.

6 Dry your face.

7 Clean the appliance after use.

Note: Make sure you rinse all foam or shaving gel off the appliance.

Turbo setting (specific types only)

The appliance is equipped with a Turbo or Turbo+ setting. This allows you to shave hard-to-reach areas more quickly.

- 1 Switch on the appliance.
- 2 To activate the Turbo setting, press the Turbo button once when the appliance is switched on.

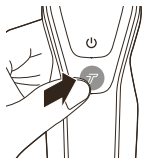

- 3 Move the shaving heads over your skin in circular movements to catch all hairs growing in different directions. Make sure each shaving head is fully in contact with the skin. Exert gentle pressure for a close, comfortable shave.

Note: Circular movements provide better shaving results than straight movements.

- 4 To deactivate the Turbo setting, press the Turbo button once.

Using the click-on attachments

Note: The accessories supplied may vary for different products. The box shows the accessories that have been supplied with your product.

Removing or attaching click-on attachments

- 1 Make sure the appliance is switched off.
- 2 Pull the attachment straight off the appliance.

Note: Do not twist the attachment while you pull it off the appliance.



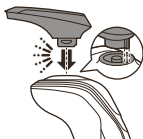

- 3 Insert the lug of the attachment into the slot in the top of the appliance. Then press down the attachment to attach it to the appliance ('click').

Using the precision trimmer attachment

You can use the precision trimmer attachment to touch up your beard, sideburns and moustache.

- 1 Attach the attachment to the appliance ('click').
- 2 Switch on the appliance.

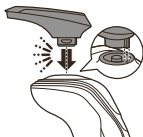

- 3 Hold the trimmer attachment perpendicular to the skin and move the appliance downwards while you exert gentle pressure.
- 4 Clean the attachment after use (see 'Cleaning and maintenance').



Using the beard styler attachment with comb

You can use the beard styler attachment with the comb attached to style your beard at one fixed setting or at different length settings. You can also use it to pre-trim any long hairs before shaving for a more comfortable shave.

The length settings on the beard styler attachment correspond to the remaining hair length after cutting and range from 1 to 5 mm (3/64 - 3/16 in).

- 1 Attach the attachment to the appliance ('click').

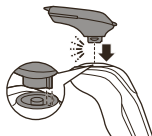



- 2 Slide the comb straight into the guiding grooves on both sides of the beard styler attachment ('click').

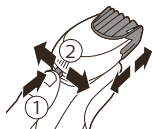

- 3 Press the length selector and then push it to the left or right to select the desired hair length setting.
- 4 Switch on the appliance.



- 5 Move the appliance upwards while you exert gentle pressure. Make sure the front of the comb is in full contact with the skin.
- 6 Clean the attachment after use (see 'Cleaning and maintenance').

Using the beard styler attachment without comb

You can use the beard styler attachment without the comb to contour your beard, moustache, sideburns or neckline at a length of 0.5 mm (1/32 in).

- 1 Pull the comb off the beard styler attachment.

Note: Grab the comb in the center to pull it off the beard styler attachment. Do not pull at the sides of the comb.

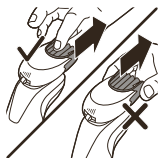

- 2 Switch on the appliance.



- 3 Hold the beard styler attachment perpendicular to the skin and move the appliance downwards while you exert gentle pressure.
- 4 Clean the attachment after use (see 'Cleaning and maintenance').

Using the cleansing brush attachment

Note: For better shaving results, use the click-on cleansing brush attachment before shaving.

Use the rotating cleansing brush with your daily cleansing cream. The cleansing brush removes oil and dirt, contributing to a healthy and oil-free skin. We advise you to use it no more than twice a day.

Do not use the appliance on damaged or irritated skin or on wounds.

- 1 Place the attachment on the attachment holder.
- 2 Attach the attachment to the appliance ('click').

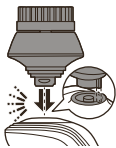

- 3 Moisten the attachment with water.

Note: Do not use the appliance with a dry cleansing brush attachment, as this can irritate the skin.



- 4 Moisten your face with water and apply a cleanser to your face.
- 5 Place the attachment on your cheek.
- 6 Switch on the appliance.



- 7** Gently move the brush across your skin from the nose towards the ear. Do not push the brush too hard onto the skin to make sure that the treatment remains comfortable.

Note: Do not cleanse the sensitive area around your eyes.



- 8** After approx. 20 seconds, move the appliance to your other cheek and start cleansing this part of your face.



- 9** After approx. 20 seconds, move the appliance to your forehead and start cleansing this part of your face. Gently move the brush head from left to right.

Note: We advise you to not overdo the cleansing and to not cleanse any zone longer than 20 seconds.

- 10** Switch off the appliance and clean the attachment after use.



- 11** After the treatment, rinse and dry your face. Your face is now ready for the next step of your daily skincare routine.

Using the nose/ear trimmer attachment

You can use the nose/ear trimmer attachment to trim your nose and/or ear hair.

Trimming nose hair

When trimming nose hair, make sure your nostrils are clean.

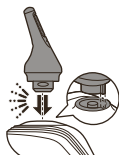

- 1 Attach the attachment to the appliance ('click').
- 2 Switch on the appliance.
- 3 Carefully insert the attachment into one of your nostrils.

Do not insert the attachment more than 0.5 cm into your nostrils.



- 4 Slowly move the attachment around to remove all unwanted hairs in your nostrils.
- 5 Clean the attachment after use (see 'Cleaning and maintenance').

Trimming ear hair

When trimming ear hair, make sure your outer ear channels are clean and free from wax.

- 1 Attach the attachment to the appliance ('click').
- 2 Switch on the appliance.
- 3 Slowly move the attachment along the rim of the ear to remove hairs that stick out beyond the rim.
- 4 Insert the attachment into the outer ear channel.

Do not insert the attachment more than 0.5 cm into your ear channel, as this could damage the eardrum.

- 5 Slowly turn the attachment around to remove all unwanted hairs from your outer ear channel.
- 6 Clean the attachment after use (see 'Cleaning and maintenance').



Cleaning and maintenance

Note: The accessories supplied may vary for different products. The box shows the accessories that have been supplied with your product.

Cleaning the shaver in the SmartClean system



Preparing the SmartClean system for use

Caution: Do not tilt the SmartClean system to prevent leakage.

Note: Hold the SmartClean system while you prepare it for use.

Note: If you clean the shaver in the SmartClean system once a week, the SmartClean cartridge lasts approximately three months.

- 1 Put the small plug in the back of the SmartClean system.
- 2 Put the supply unit in the wall socket.
- 3 While holding the SmartClean system with one hand, press the button on the side of the SmartClean system and lift the top part of the SmartClean system.
- 4 Pull the seal off the cleaning cartridge.
- 5 Place the cleaning cartridge in the SmartClean system.

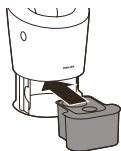
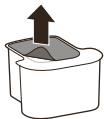
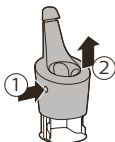



- 6 While holding the SmartClean system with one hand, gently push the top part of the SmartClean system back down ('click').

Using SmartClean

Note: If you use the shaver with shaving foam, shaving gel or pre-shave products, briefly rinse the shaver with warm water before you clean it in SmartClean.

Caution: Always shake excess water off the shaver before you place it in the SmartClean system.

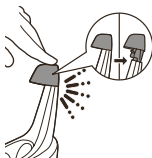
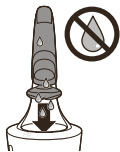

- 1 Press to open the SmartClean cap, to be able to place the shaver in the holder ('click').

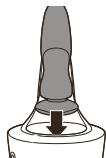

- 2 Hold the shaver upside down above the holder. Make sure the front of the shaver points towards the SmartClean holder.

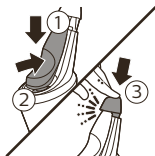

- 3 Place the shaver in the holder (1), tilt the shaver backwards (2) and press down the top cap to connect the shaver ('click') (3).

The battery symbol on SmartClean starts to flash, which indicates that the shaver is charging.

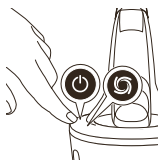

- 4** Press the on/off button on SmartClean to start the cleaning program.

During the cleaning phase, the cleaning symbol flashes. When the cleaning phase is done (after approx. 10 minutes), the cleaning symbol lights up continuously.

Next, the ready symbol lights up continuously.

30 minutes after the cleaning program and charging are done, SmartClean switches off automatically.

The battery symbol lights up continuously to indicate that the shaver is fully charged. Charging takes approx. 1 hour.

- 5** To let the shaver dry, you can leave it in the SmartClean system until your next shave. You can also remove the shaver from the SmartClean system, shake off excess fluid, open the shaving unit and let the shaver air-dry. Press to open the SmartClean cap, to remove the shaver from the holder ('click').

Note: If you press the on/off button of SmartClean during the cleaning program, the program stops. In this case, the cleaning or drying symbol goes out.

Note: If you disconnect SmartClean from its power supply, the cleaning program stops.

Replacing the SmartClean cartridge

Replace the cleaning cartridge when the replacement symbol flashes orange or when you are no longer satisfied with the cleaning result. If you clean the shaver with SmartClean once a week, the cartridge lasts approximately three months.

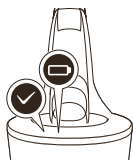

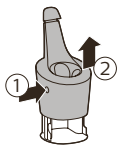

1 While holding SmartClean with one hand, press the button on the side of SmartClean and lift the top part of the SmartClean.

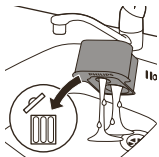

2 Remove the cleaning cartridge from SmartClean and pour out any remaining cleaning fluid. You can safely pour the cleaning fluid down the sink.

3 Discard the empty cleaning cartridge.

4 Unpack the new cleaning cartridge and pull off the seal.

5 Place the cleaning cartridge in the SmartClean.

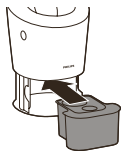

6 While holding SmartClean with one hand, gently push the top part back down ('click').



Cleaning the shaver under the tap

Clean the shaver after every use for optimal performance.

Be careful with hot water. Always check if the water is not too hot, to prevent burning your hands.

Never dry the shaving unit with a towel or tissue, as this may damage the shaving heads.

While rinsing the shaving unit, water may drip out of the base of the shaver. This is a normal occurrence.

- 1 Switch on the appliance.
- 2 Rinse the shaving unit under a warm tap.



- 3 Switch off the appliance. Press the release button to open the shaving unit.



- 4 Rinse the hair chamber under the tap.



- 5 Rinse the shaving head holder under a warm tap.
- 6 Carefully shake off excess water and let the shaving head holder air-dry completely.



- 7 Close the shaving head holder ('click').



Cleaning the click-on attachments

Never dry trimmer or beard styler attachments with a towel or tissue, as this may damage the trimming teeth.

The accessories supplied may vary for different products. The box shows the accessories that have been supplied with your product.

Cleaning the precision trimmer attachment

Clean the trimmer attachment after each use.

- 1 Switch on the appliance with the precision trimmer attachment attached.
- 2 Rinse the attachment under a warm tap.
- 3 After cleaning, switch off the appliance.
- 4 Carefully shake off excess water and let the attachment air-dry completely.

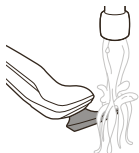

For optimal performance, lubricate the teeth of the attachment with a drop of sewing machine oil every six months.

Cleaning the beard styler attachment

Clean the beard styler attachment after each use.

- 1 Pull the comb off the beard styler attachment.

Note: Grab the comb in the center to pull it off the beard styler attachment. Do not pull at the sides of the comb.

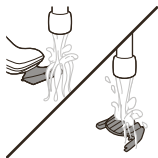
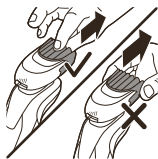

- 2 Rinse the cut hairs off the cutting unit with lukewarm water.
- 3 Rinse the cut hairs off the comb.



4 Remove the cutting unit from the beard styler attachment. By pushing the cutting unit from the beard styler attachment you can remove any hairs that have accumulated inside the beard styler. You can also rinse the back of the cutting unit.

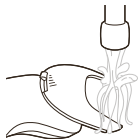

5 Rinse cut hairs out of the beard styler attachment.

6 Carefully shake off excess water and leave the comb, cutting unit and beard styler attachment to dry before next usage.



7 When the cutting unit is dry attach it to the beard styler attachment.



8 When the comb is dry, re-attach it to the beard styler.

9 For optimal performance, lubricate the teeth of the attachment with a drop of sewing machine oil regularly.

Cleaning the cleansing brush attachment

Clean the cleansing brush attachment after each use.

1 Switch off the appliance.

2 Detach the brush head from the attachment holder.

3 Clean the parts thoroughly with warm water and soap.

4 Dry the cleansing brush attachment with a towel.

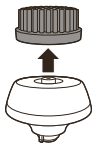

Cleaning the nose trimmer attachment

Clean the nose trimmer attachment every time you have used it.



- 1 Make sure the appliance is switched off.
- 2 Rinse the cutting element with hot water.
- 3 Switch on the appliance and rinse the cutting element once more to remove any remaining hairs. Then switch off the appliance again.
- 4 Carefully shake off excess water and let the nose trimmer attachment dry.

Tip: For optimal trimmer performance, lubricate the trimmer teeth with a drop of sewing machine oil every six months.

Storage

We advise you to let the appliance and its attachments dry before you put the protection caps on the attachments or store the shaver in the pouch.

Note: The accessories supplied may vary for different products. The box shows the accessories that have been supplied with your product.

Store the shaver in the pouch (if supplied).



Put the protection cap on the shaver to protect it from any dirt accumulation.



Place the protection cap on the nose trimmer attachment.



Put the protection cap on the cleansing brush attachment to protect it from dirt accumulation.

Replacement

Replacing the shaving heads



For maximum shaving performance, we advise you to replace the shaving heads every two years. Replace damaged shaving heads immediately. Always replace the shaving heads with original Philips shaving heads (see 'Ordering accessories').

Replacement reminder



The replacement reminder indicates that the shaving heads need to be replaced. The shaving unit symbol and arrows light up when you switch off the appliance.

- 1 Switch off the appliance.
- 2 Press the release button to open the shaving unit.



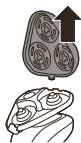

- 3** Pull the shaving head holder off the bottom part of the shaving unit.

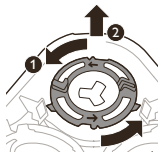

- 4** Turn the retaining rings counterclockwise and remove them. Place them aside in a safe place.



- 5** Remove the shaving heads from the shaving head holder.

Discard the used shaving heads immediately to avoid mixing them with the new shaving heads.

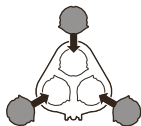

- 6** Place the new shaving heads in the shaving head holder.

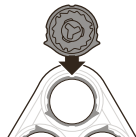

Note: Make sure that the projections of the shaving heads fit exactly into the recesses of the shaving head holder.

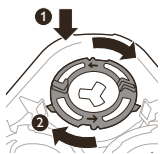

- 7** Place the retaining rings back onto the shaving heads and turn them clockwise to reattach the retaining ring.

Each retaining ring has two recesses and two projections that fit exactly in the projections and recesses of the shaving head holder.

- Turn the ring clockwise until you hear a click to indicate that the ring is fixed.

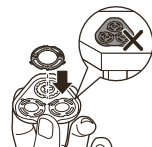
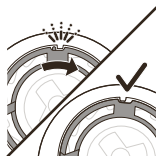

Note: Hold the shaving head holder in your hand when you reinsert the shaving heads and reattach the retaining rings. Do not place the shaving head holder on a surface, as this may cause damage to the shaving heads.



- 8** Reinsert the hinge of the shaving head holder into the slot of the shaving unit. Close the shaving head holder ('click').



- 9** To reset the replacement reminder, press and hold the on/off button for approx. 7 seconds.

Replacing the cleansing brush attachment

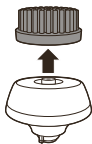

The cleansing brush attachment should be replaced every 3 months or earlier if the brush hairs are bent or damaged (see 'Ordering accessories').

Ordering accessories

To buy accessories or spare parts, visit **www.philips.com/parts-and-accessories** or go to your Philips dealer. You can also contact the Philips Consumer Care Center in your country (see the international warranty leaflet for contact details).

The following accessories and spare parts are available:

- SH50 Philips shaving heads
- HQ110 Philips shaving head cleaning spray
- RQ111 Philips beard styler attachment
- RQ585 Philips cleansing brush attachment
- RQ560, RQ563 Philips cleansing brush heads
- JC301, JC302, JC303, JC304, JC305 cleaning cartridge
- HQ8505 supply unit

Note: The availability of the accessories may differ by country.

Recycling

- Do not throw away the product with the normal household waste at the end of its life, but hand it in at an official collection point for recycling. By doing this, you help to preserve the environment.

- This product contains a built-in rechargeable battery which shall not be disposed of with normal household waste. Please take your product to an official collection point or a Philips service center to have a professional remove the rechargeable battery.
- Follow your country's rules for the separate collection of electrical and electronic products and rechargeable batteries. Correct disposal helps prevent negative consequences for the environment and human health.

Removing the rechargeable shaver battery

Only remove the rechargeable battery when you discard the appliance. Before you remove the battery, make sure that the appliance is disconnected from the mains and that the battery is completely empty.

Take any necessary safety precautions when you handle tools to open the appliance.

Be careful, the battery strips are sharp.

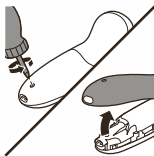

- 1 Remove the screw in the back of the shaver.
- 2 Remove the back panel.

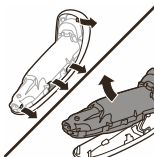

- 3 Take out the power unit.

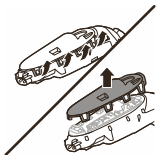

- 4 Bend the snap hooks aside and remove the transparent cover of the power unit.

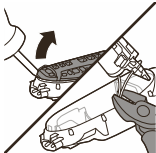

- 5 Lift out the battery holder and cut the wires with a pair of cutting pliers or scissors.

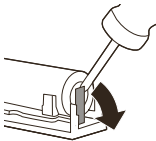

- 6 Bend the battery tags aside with a pair of cutting pliers or a screw driver.
7 Remove the rechargeable batteries.

Warranty and support

If you need information or support, please visit www.philips.com/support or read the international warranty leaflet.

Warranty restrictions

The shaving heads (cutters and guards) are not covered by the terms of the international warranty because they are subject to wear.

Troubleshooting

This chapter summarizes the most common problems you could encounter with the appliance. If you are unable to solve the problem with the information below, visit www.philips.com/support for a list of frequently asked questions or contact the Consumer Care Center in your country.

Shaver

Problem	Possible cause	Solution
The appliance does not work when I press the on/off button.	The appliance is still attached to the wall socket. For safety reasons, the appliance can only be used without charging cord.	Unplug the appliance and press the on/off button to switch on the appliance.
	The rechargeable battery is empty.	Recharge the battery.
	The travel lock is activated.	Press the on/off button for 3 seconds to deactivate the travel lock.
	The shaving unit is soiled or damaged to such an extent that the motor cannot run.	Clean the shaving heads thoroughly or replace them.
The appliance does not shave as well as it used to.	The shaving heads are damaged or worn.	Replace the shaving heads.
	Hairs or dirt obstruct the shaving heads.	Clean the shaving heads in the regular way or clean them thoroughly.
I replaced the shaving heads, but the replacement reminder is still showing.	You have not reset the replacement reminder.	To reset the replacement reminder, press and hold the on/off button for more than 7 seconds.
A shaving head symbol has suddenly appeared on the display.	This symbol is the replacement reminder.	Replace the shaving heads.

Problem	Possible cause	Solution
Water is leaking from the bottom of the appliance.	During cleaning, water may collect between the inner body and the outer shell of the appliance.	This is normal and not dangerous because all electronics are enclosed in a sealed power unit inside the appliance.

SmartClean

Problem	Possible cause	Solution
The SmartClean does not work when I press the on/off button.	The SmartClean is not connected to the wall socket.	Put the small plug in the SmartClean and put the supply unit in the wall socket.
	The cleaning cartridge is empty. The replacement symbol flashes to indicate that you have to replace the cleaning cartridge.	Place a new cleaning cartridge in the SmartClean.
The shaver is not entirely clean after I clean it with the SmartClean.	You have not placed the shaver in SmartClean properly, so there is no electrical connection between SmartClean and the shaver.	Press down the top cap ('click') to ensure a proper connection between the shaver and the SmartClean.

Problem	Possible cause	Solution
	The battery of the shaver is not charged sufficiently.	If the battery of the shaver is not charged sufficiently, the SmartClean may not work properly. The shaver needs to be able to switch on briefly during the rinsing phase. Charge the shaver for a short time before you use the SmartClean to clean your shaver.
	The cleaning cartridge needs to be replaced.	Replace the cleaning cartridge.
	You have used another cleaning fluid than the original Philips Norelco cleaning cartridge.	Only use the original Philips Norelco cleaning cartridge.
	The hole of the drain of the cleaning cartridge is blocked.	Remove the cartridge from the SmartClean and push the hairs down the drain with a toothpick.
The shaver is not fully charged after I charge it in SmartClean.	You have not placed the shaver in SmartClean properly, so there is no electrical connection between SmartClean and the shaver.	Press down the top cap ('click') to ensure a proper connection between the shaver and SmartClean.

Problem	Possible cause	Solution
The nose trimmer attachment pulls at the hairs.	You move the appliance too fast.	Slowly move the attachment around to remove all unwanted hairs in your nostrils.

Problem	Possible cause	Solution
The nose trimmer attachment does not work.	The cutting element of the attachment is very dirty, for instance because some nasal mucus has dried inside the cutting element.	Clean the cutting element by rinsing it under the tap with hot water. Switch on the appliance and rinse the cutting element once more to remove any remaining hairs
		If rinsing the nose trimmer under the tap does not unblock the cutting element, then immerse it in a glass with warm water for a few minutes. Then switch on the appliance and rinse it under the tap.

基本说明

- 1 鼻毛修剪器附件保护盖（仅限 S5530/37）
- 2 卡入式鼻毛修剪器附件（仅限 S5530/37）
- 3 洁面刷附件保护盖（仅限 XZ5810/70、S5580/68、S5571/68、S5570/43、S5570/33、S5560/33）
- 4 卡入式洁面刷附件（仅限 XZ5810/70、S5580/68、S5571/68、S5570/43、S5570/33、S5560/33）
- 5 适用于胡须造型器附件的修剪梳（仅限 S5580/68、S5571/68、S5570/33、S5560/33）
- 6 卡入式胡须造型器附件（S5580/68、S5571/68、S5570/33、S5560/33）
- 7 卡入式精确修剪器附件（仅限 XZ5810/70、S5580/68、S5571/68、S5570/43、S5380/04、S5370/04、S5530/37）
- 8 剃须刀头部件保护盖（仅限 XZ5810/70、S5888/75、S5380/04、S5370/04）
- 9 卡入式剃须刀头部件
- 10 剃须刀头部件释放按钮
- 11 开/关按钮
- 12 Turbo 按钮
- 13 手柄
- 14 小插头插座

- 15 电池充电指示灯（3 级指示）
- 16 “不要接电源使用” 指示灯
- 17 旅行锁指示灯
- 18 更换提醒
- 19 清洗提示
- 20 适用于高效智能清洁系统的清洁滤芯
（仅限 XZ5810/70、S5888/75、
S5570/33、S5560/33、S5551/27、
S5530/37）
- 21 高效智能清洁系统（仅限 XZ5810/70、
S5888/75、S5570/33、S5560/33、
S5551/27、S5530/37）
- 22 高效智能清洁系统顶盖（仅限
XZ5810/70、S5888/75、S5570/33、
S5560/33、S5551/27、S5530/37）
- 23 开/关按钮
- 24 更换符号
- 25 冲洗符号
- 26 准备就绪指示灯
- 27 电量指示灯
- 28 电源部件
- 29 小插头
- 30 存储袋（仅限 XZ5810/70、
S5570/43、S5570/33、S5560/33、
S5530/37）

随附的附件可能因产品而异。包装盒上会显示随附于您产品的附件。

简介

感谢您的惠顾，很高兴您选择飞利浦！为了让您能充分享受飞利浦提供的支持，请在 www.philips.com/welcome 上注册您的产品。

重要安全信息

使用本产品及其附件之前，请仔细阅读本重要信息，并妥善保管以供日后参考。随附的附件可能因产品而异。

危险



- 保持电源部件干燥。
- 警告符号注释：禁止在打开的水龙头下进行清洗。

警告

- 要给电池充电，请仅使用产品随附的可拆卸电源部件 (HQ8505)。
- 电源部件中包含一个变压器。请勿自行更换电源部件的插头，否则将导致严重后果。

- 本产品也可以由 8 岁或以上年龄的儿童以及肢体不健全、感觉或精神上有障碍或缺乏相关经验和知识的人士使用，但前提是有人对他们使用本产品进行监督或指导，以确保他们安全使用，并且让他们明白相关的危害。切勿让儿童玩弄本产品。不要让儿童在无人监督的情况下对本产品进行清洁和保养。
- 将剃须刀手持部分与电源软线分开后，才能在水龙头下清洗手持部分。
- 使用前，请务必检查产品。请勿使用损坏的产品，否则可能对人体造成伤害。请务必用原装型号更换损坏的部件。
- 本产品包含的电池不可更换。
- 切勿拆开本产品更换充电电池。

注意



- 切勿将清洁系统或充电座浸入水中，也不要在水龙头下冲洗。
- 警告符号注释：禁止用在打开的水龙头下进行清洗。
- 切勿使用温度高于 60° C 的热水冲洗剃须刀。
- 只能将本产品用于用户手册中所示的原定用途。
- 出于卫生的目的，本产品只能供一个人使用。

- 切勿使用压缩气体、钢丝绒、研磨性清洁剂或腐蚀性液体（例如汽油或丙酮）来清洁产品。
- 如果剃须刀随附清洁系统，应始终使用原装飞利浦清洁液（滤芯或瓶，取决于清洁系统类型）。
- 清洁系统必须放在稳定、平坦的水平表面上，以防漏液。
- 如果清洁系统采用清洁滤芯，在使用清洁系统进行清洁或为剃须刀充电之前，应始终确保滤芯仓已关闭。
- 清洁系统准备就绪时，切勿移动，以免清洁液漏出。
- 冲洗剃须刀时，水可能从产品底部的插口漏出。这是正常的，而且没有危险，因为所有电子元件都封闭在剃须刀内部的密封电源部件中。
- 请勿在包含电动空气清新器的墙壁插座上或其周围使用电源部件，以免电源部件受到不可修复的损坏。

电磁场 (EMF)

本 Philips 产品符合所有有关暴露于电磁场的适用标准和法规。

概述

- 符号注释：适合于在洗澡或淋浴时使用。允许在盛水的浴缸、淋浴、洗脸盆或其他器皿附近使用本器具。



- 该剃须刀具有防水性能。适合在沐浴或淋浴时使用，也可以放在水龙头下清洗。出于安全原因，该剃须刀在使用时不能连接电线。
- 电源部件适合在 100 - 240 伏的电源电压下工作。
- 该电源部件可将 100-240 伏的电压转换为 24 伏以下的安全低电压。

显示屏

充电

注意：充电期间按开/关按钮，“拔出插头即可使用”符号会呈白色闪烁，提醒您需断开产品与电源插座的连接。

快速充电：电池电量耗尽后，当您将产品连接到电源插座时，电池充电指示灯将逐个亮起并重复循环。产品包含的电量足够完成一次剃须时，底部的电池充电指示灯开始缓慢闪烁。

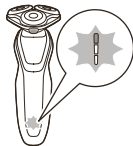

产品如果继续充电，底部的电池充电指示灯先是闪烁，然后持续亮起。然后，第二个指示灯闪烁，之后持续亮起，以此类推，直至本产品充满电。

电池已完全充满

注意：电池充满电后，显示屏会在 30 分钟后自动关闭。

注意：本产品只能在不接电源的情况下使用。



电池充满电后，所有电池充电指示灯都将呈白色持续亮起。

电池电量不足



当电池电量几乎耗尽时，电池充电指示灯的底灯会呈橙色闪烁。

电池剩余电量



剩余的电池电量由持续亮起的充电指示灯来表示。

“拔出插头即可使用”提示

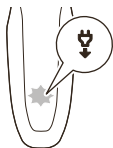

“拔出插头即可使用”符号闪烁，提醒您应先断开产品与电源插座的连接后才能打开本产品。

清洗提示

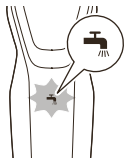

每次使用后请清洁剃须刀，以获得出色性能。关闭产品时，清洗提示符号闪烁，提醒您需要清洁产品。

旅行锁



您可以在携带本产品旅行之前将其锁住。旅行锁可防止本产品被意外启动。

启用旅行锁

- 1 按住开/关按钮 3 秒钟以进入旅行锁模式。



启用旅行锁后，旅行锁符号会持续亮起。旅行锁启用后，旅行锁符号将闪烁。



如果在旅行锁处于激活状态下尝试打开剃须刀，旅行锁符号将闪烁。

解除旅行锁

- 1 按开/关按钮 3 秒钟。



禁用旅行锁后，旅行锁符号会短暂亮起且剃须刀会发出短促声音。剃须刀打开后即可供再次使用。

更换提示



为获得更好剃须效果，建议每两年更换一次剃须刀头。本产品配有更换提示，它会提醒您更换剃须刀头。剃须刀头部件符号和箭头亮起，表示需要更换剃须刀头（请参见‘更换剃须刀头’）。

注意： 更换剃须刀头后，您需要通过按开/关按钮 7 秒来重置更换提醒。

高速设置（仅限于特定型号）

本产品配备了 Turbo 或 Turbo+ 设置。该设置用于更快速、更强力地剃须，可以轻松剃除难以到达部位的须发。

启用 Turbo 设置

- 1 要启用 Turbo 设置，请在启动产品后按一下 Turbo 按钮。

禁用 Turbo 设置

- 1 要禁用 Turbo 设置，请按一下 Turbo 按钮。

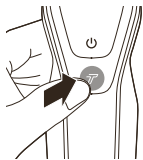

充电

首次使用剃须刀之前，或当显示屏指示电池电量几乎耗尽时，请先为剃须刀充电。

充电约需 1 小时。

注意：不能在充电时使用本产品。

使用电源部件充电

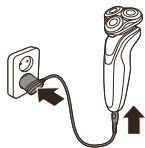

- 1 确保产品电源已关闭。
- 2 将小插头插入本产品，然后将电源部件插入电源插座。
- 3 充电之后，从电源插座上拔下电源部件，并从本产品上拔下小插头。

注意：电池充满电后，显示屏会在 30 分钟后自动关闭。

在高效智能清洁系统中充电（仅限于特定型号）

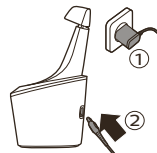

- 1 将小插头插入高效智能清洁系统的背面。
- 2 将电源部件插入电源插座。

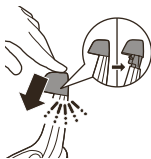

- 3 按下可打开高效智能清洁系统的盖子，以便将剃须刀放入支架（可听到“咔哒”一声）。

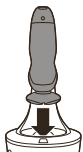

- 4 将剃须刀倒置放在支架上方。确保剃须刀的正面朝向高效智能清洁系统的支架。

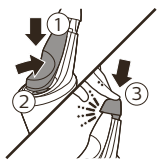

- 5 将剃须刀放入支架并向后倾斜，然后按下高效智能清洁系统的盖子以连接剃须刀（可听到“咔哒”一声）。

电池符号闪烁表示产品正在充电。当电池已完全充满电时，电池符号将持续亮起。

使用本产品

注意： 本产品只能在不接电源的情况下使用。

打开或关闭产品

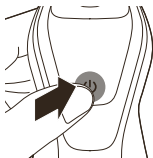

- 1 要打开本产品，请按一下开/关按钮。
- 2 要关闭产品，请按一下开/关按钮。

显示屏将亮起几秒钟时间，以显示电池剩余电量状态。

剃须

皮肤适应期

前几次剃须可能不会带给您预期效果，并且您的皮肤可能会受到轻度刺激。这是正常的。您的皮肤和胡须需要时间适应任何新的剃须系统。为了让您的皮肤适应这款新产品，我们建议您在 3 周时间内定期（至少每周 3 次）仅使用本产品剃须。

干剃

- 1 启动产品。



- 2 让剃须刀头在您的皮肤上作迂回运动，以刮剃向不同方向生长的所有须发。轻轻按压，以获取舒适贴面的剃须感受。

注意：不要用力按压剃须刀，这样做可能会导致皮肤疼痛。

- 3 使用后要清洁本产品。

湿剃

要获得更舒适的剃须体验，您也可以先用剃须泡沫或剃须啫喱将脸弄湿，然后再用本产品进行剃须。

要用剃须泡沫或剃须啫喱剃须，请按照下面的步骤执行操作：

- 1 用水润湿皮肤。



- 2 在皮肤上涂抹剃须泡沫或剃须啫喱。



- 3 在水龙头下冲洗一下剃须刀头部件，确保剃须刀头部件可以在您的皮肤上顺畅滑动。



- 4 启动产品。



- 5 让剃须刀头在您的皮肤上作迂回运动，以刮剃向不同方向生长的所有须发。轻轻按压，以获取舒适贴面的剃须感受。

注意：不要用力按压剃须刀，这样做可能会导致皮肤疼痛。

注意：定期冲洗剃须刀头部件，确保其能够在您的皮肤上顺畅滑动。

- 6 擦干面部。
- 7 使用后要清洁本产品。

注意：确保冲洗干净本产品上的所有泡沫或剃须啫喱。

高速设置（仅限于特定型号）

本产品配备了 Turbo 或 Turbo+ 设置。使用该功能，您可以快速剃除难以到达部位的须发。

- 1 启动产品。
- 2 要启用 Turbo 设置，请在启动产品后按一下 Turbo 按钮。

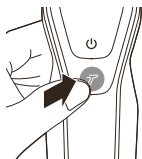

- 3 让剃须刀头在您的皮肤上作迂回运动，以刮剃向不同方向生长的所有须发。轻轻按压，以获取舒适贴面的剃须感受。

注意：划圈动作比直线动作的剃须效果更好。

- 4 要禁用 Turbo 设置，请按一下 Turbo 按钮。

使用卡入式附件

注意：随附的附件可能因产品而异。包装盒上会显示随附于您产品的附件。

拆卸或安装卡入式附件

- 1 确保产品电源已关闭。
- 2 将附件竖直抽离产品。

注意：将附件从产品上抽出时，不要旋转。

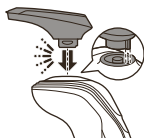

- 3 将附件的凸缘插入本产品顶部的槽内。然后，按下附件将其安装到本产品上（可听到“咔哒”一声）。

使用精确修剪器附件

您可使用修剪器附件修剪鬓角和须髯。

- 1 将附件安装到产品上（可听到“咔哒”一声）。
- 2 启动产品。

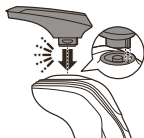

- 3 将修剪器附件垂直放在皮肤上，向下移动产品，同时轻轻按压。
- 4 使用 (请参见 '清洁和保养')后要清洁附件。



使用带修剪梳的胡须造型器附件

您可以使用带修剪梳的胡须造型器附件以固定设置（或者使用不同的长度设置）修整胡须。您也可以在剃须前用其预先修剪较长须发，以实现更舒适的剃须体验。

胡须造型器附件的长度设置对应修剪后剩余的须发长度，范围为 1 到 5 毫米（3/64 - 3/16 英寸）。

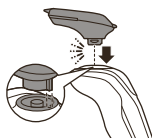

- 1 将附件安装到产品上（可听到“咔哒”一声）。



- 2 将修剪梳直接滑入胡须造型器附件两侧的导槽中（可听到“咔哒”一声）。

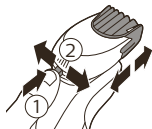

- 3 按下长度选择器，然后将其向左或向右推动以选择所需的须发长度设置。
- 4 启动产品。



- 5 向上移动产品，同时轻轻按压。确保修剪梳的正面与皮肤完全接触。
- 6 使用（请参见“清洁和保养”）后要清洁附件。

使用不带修剪梳的胡须造型器附件

您可以使用不带修剪梳的胡须造型器附件将胡须、须髥、鬓角或颈部轮廓修整至 0.5 毫米（1/32 英寸）。

1 将修剪梳抽离胡须造型器附件。

注意： 抓住修剪梳的中间位置，将其抽离胡须造型器附件。不要拉拔修剪梳的侧面。

2 启动产品。

3 将胡须造型器附件垂直放在皮肤上，向下移动产品，同时轻轻按压。

4 使用 (请参见 '清洁和保养')后要清洁附件。

使用洁面刷附件

注意： 为获得更佳的剃须效果，剃须之前使用卡入式洁面刷附件进行清洁。

将旋转洁面刷与日常洁面产品一起使用。洁面刷可去除油脂和污垢，焕发健康无油脂的肌肤。建议每天使用本产品不超过 2 次。

请不要在受伤或发炎的皮肤或伤口上使用本产品。

1 将附件安装至附件支架上。

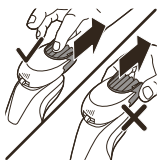

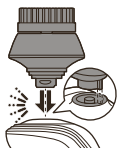

- 2 将附件安装到产品上（可听到“咔哒”一声）。



- 3 用水湿润附件。

注意：切勿在洁面刷附件干燥的情况下使用产品，否则可能会刺激皮肤。



- 4 用水润湿面部，并将洁面乳涂抹到脸上。

- 5 将附件置于面颊上。

- 6 启动产品。



- 7 在鼻子至耳朵的皮肤上轻轻地移动刷头。请勿太过用力地将刷子压在皮肤上，以确保舒适护理。

注意：切勿清洁眼部周围的敏感区域。



- 8 约 20 秒后，可将本产品移至另一侧面颊，开始清洁这部分面部皮肤。



9 约 20 秒后，可将本产品移至前额，开始清洁这部分面部皮肤。轻轻将刷头从左向右移动。

注意：建议您不要过度清洁，任何部位的清洁时间不要超过 20 秒钟。



10 使用后，请关闭本产品并清洁附件。

11 护理后，洗脸并擦干。现在您可以进行日常面部护肤的下一步了。

使用鼻毛/耳毛修剪器附件

您可以使用鼻毛/耳毛修剪器附件修剪鼻毛和/或耳毛。

修剪鼻毛

修剪鼻毛时，请确保鼻腔保持清洁。

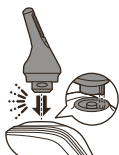

1 将附件安装到产品上（可听到“咔哒”一声）。

2 启动产品。

3 将附件小心地插入其中一个鼻孔。

附件插入鼻孔的深度不得超过 0.5 厘米。



4 缓缓地来回移动附件，以剃掉鼻孔中所有多余的毛发。

5 使用（请参见‘清洁和保养’）后要清洁附件。

修剪耳毛

修剪耳毛时，请确保外耳道保持清洁，没有耳垢。

- 1 将附件安装到产品上（可听到“咔哒”一声）。
- 2 启动产品。
- 3 缓缓地沿着耳缘移动附件，以剃掉突出耳缘的毛发。
- 4 将附件插入外耳道。

附件插入耳道的深度不能超过 0.5 厘米，否则可能损伤鼓膜。

- 5 缓缓地转动附件，以剃掉外耳道中所有多余的毛发。
- 6 使用（请参见‘清洁和保养’）后要清洁附件。



清洁和保养

注意： 随附的附件可能因产品而异。包装盒上会显示随附于您产品的附件。

在高效智能清洁系统中清洁剃须刀

高效智能清洁系统使用准备

警告： 切勿倾斜高效智能清洁系统，以防溢漏。

注意： 在准备使用高效智能清洁系统时用手握住。

注意： 如果您每周在高效智能清洁系统中清洁一次剃须刀，则高效智能清洁系统滤芯可持续工作约 3 个月。

- 1 将小插头插入高效智能清洁系统的背面。



2 将电源部件插入电源插座。

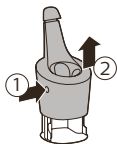

3 一只手抓住高效智能清洁系统，同时按高效智能清洁系统侧面的按钮，然后提起高效智能清洁系统的顶部。

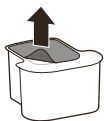

4 将密封圈从清洁滤芯上拔下。

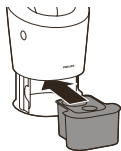

5 将清洁滤芯放置在高效智能清洁系统中。



6 一只手抓住高效智能清洁系统，然后将高效智能清洁系统的顶部向下轻轻推回去（可听到“咔哒”一声）。

使用高效智能清洁系统

注意： 如果您在剃须时使用了剃须泡沫、剃须啫喱或剃须前用品，则在将本剃须刀放入高效智能清洁系统进行清洁之前，请先用温水冲洗片刻。



警告： 将剃须刀放入高效智能清洁系统之前，务必确保甩掉剃须刀上多余的水份。

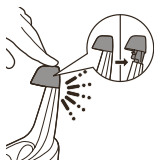

- 1 按下可打开高效智能清洁系统的盖子，以便将剃须刀放入支架（可听到“咔哒”一声）。

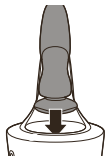

- 2 将剃须刀倒置放在支架上方。确保剃须刀的正面朝向高效智能清洁系统的支架。

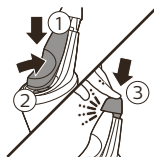

- 3 将剃须刀放在支架中 (1)，将剃须刀向后倾斜 (2)，然后按下顶盖以连接剃须刀（可听到“咔哒”一声）(3)。

高效智能清洁系统上的电池符号开始闪烁，这表示剃须刀正在充电。



- 4 按高效智能清洁系统上的开/关按钮以启动清洁程序。

在清洁期间，清洁符号闪烁。清洁阶段完成后（约 10 分钟后），清洁符号会持续亮起。

接下来，准备就绪符号将持续亮起。

在执行清洁程序和充电完成 30 分钟后，高效智能清洁系统将自动关闭。

电池符号持续亮起表示剃须刀已充满电。充电约需 1 小时。

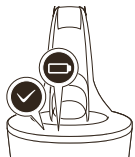

- 5 为使剃须刀干燥，可以将其放在高效智能清洁系统中，直至下次剃须。您也可以将剃须刀从高效智能清洁系统中取出，甩掉多余的水份，打开剃须刀头部件，让剃须刀晾干。按压以打开高效智能清洁系统盖，以便能够从支架上取下剃须刀（听到“咔哒”一声）。

注意：如果在清洁程序运行期间按下高效智能清洁系统的开/关按钮，则程序将停止工作。此时，清洁或干燥符号将熄灭。

注意：如果断开高效智能清洁系统的电源，则清洁程序将停止工作。

更换高效智能清洁系统的滤芯

当更换符号呈橙色闪烁时，或当您清洁效果不再满意时，请更换清洁滤芯。如果您每周在高效智能清洁系统中清洁一次剃须刀，则高效智能清洁系统滤芯可持续工作约 3 个月。

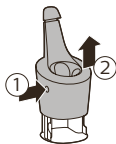

- 1 一只手抓住高效智能清洁系统，同时按高效智能清洁系统侧面的按钮，然后提起高效智能清洁系统的顶部。

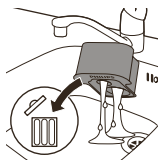

- 2 从高效智能清洁系统中取出清洁滤芯，然后将残余的所有清洁剂倒出。您可以安全地将清洁剂倒入水槽。
- 3 弃用空的清洁滤芯。

4 拆开新清洁滤芯的包装，然后将密封圈拔下。

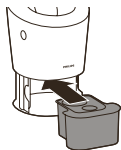

5 将清洁滤芯放置在高效智能清洁系统中。



6 一只手抓住高效智能清洁系统，然后将高效智能清洁系统的顶部向下轻轻推回去（可听到“咔哒”一声）。

在水龙头下冲洗剃须刀

每次使用后请清洁剃须刀，以获得出色性能。

使用热水要当心。切记先检查水温是否太高，以防烫手。

不要用毛巾或纸巾擦拭剃须刀头部件，因为这样可能会损坏剃须刀头。

冲洗剃须刀头部件时，水可能会从剃须刀底座中滴出。这属于正常现象。

- 1 启动产品。
- 2 用温水冲洗剃须刀头部件。





3 关闭产品。按下释放按钮，打开剃须刀头部件。



4 在水龙头下冲洗胡茬储藏室。



5 用温水冲洗剃须刀头支架。

6 小心地甩掉多余水分并彻底晾干剃须刀头支架。



7 合上剃须刀头支架（可听到“咔哒”一声）。

清洁卡入式附件

切勿用毛巾或纸巾擦干修剪器或胡须造型器附件，这样做可能会损坏修剪齿。

随附的附件可能因产品而异。包装盒上会显示随附于您产品的附件。

清洁精确修剪器附件

每次使用后都要清洁修剪器附件。

1 打开装有精确修剪器附件的产品。

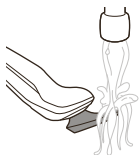

- 2 在温水水龙头下冲洗附件。
- 3 清洁完成后，关闭产品。
- 4 小心地甩干多余的水，然后将附件晾干。

为获得最佳效果，请每隔六个月用一滴缝纫机油润滑附件齿部。

清洁胡须造型器附件

每次使用后都要清洁胡须造型器附件。

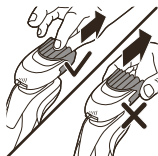

- 1 将修剪梳抽离胡须造型器附件。

注意：抓住修剪梳的中间位置，将其抽离胡须造型器附件。不要拉拔修剪梳的侧面。



- 2 用温水冲洗修剪部件上的须发。
- 3 冲洗修剪梳上的须发。



- 4 从胡须造型器附件中取下修剪部件。按下胡须造型器附件中的修剪部件，您可以清理胡须造型器内积累的须发。您也可以冲洗修剪部件的背面。

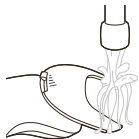

- 5 冲洗出胡须造型器附件中的须发。
- 6 小心甩干多余的水份，并晾干修剪梳、修剪部件和胡须造型器附件，以备下次使用。

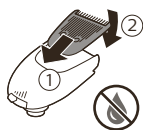

7 修剪部件晾干后，请将其安装到胡须造型器附件。



8 修剪梳晾干后，请将其重新安装到胡须造型器。

9 为获得最佳效果，请定期用一滴缝纫机油润滑附件齿部。

清洗洁面刷附件

每次使用后都要清洗洁面刷附件。

- 1 关闭产品。
- 2 从附件基座上卸下刷头。
- 3 用温水和肥皂彻底清洗部件。
- 4 用毛巾擦干洁面刷附件。

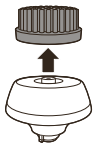

清洁鼻毛修剪器附件

每次使用后都要清洁鼻毛修剪器附件。

- 1 确保产品电源已关闭。
- 2 用热水冲洗修剪部件。
- 3 打开产品，再次冲洗修剪部件，以清除任何剩余的毛发。然后再次关闭产品。
- 4 小心地甩干多余的水份，然后将鼻毛修剪器附件晾干。



提示：为获得最佳修剪器性能，每六个月用一滴缝纫机油润滑修发器齿。

存放

建议您将产品及其配件晾干后再将保护盖放在配件上，或将剃须刀存放在收纳袋中。

注意：随附的附件可能因产品而异。包装盒上会显示随附于您产品的附件。

将剃须刀存放在收纳袋（若随附）中。



将保护盖盖在剃须刀上，以防积聚灰尘。



将保护盖盖在鼻毛修剪器附件上。



将保护盖放在洁面刷附件上，以防产品积聚灰尘。



更换

更换剃须刀头



为获得更好剃须效果，建议每两年更换一次剃须刀头。立即更换损坏的剃须刀头。务必使用原装飞利浦剃须刀头 (请参见 '订购配件') 进行更换。

更换提醒

更换提醒表示需要更换剃须刀头。关闭产品时，剃须刀头部件符号和箭头亮起。

1 关闭产品。



2 按下释放按钮，打开剃须刀头部件。



3 将剃须刀头支架从剃须刀头部件的底部抽离。



4 逆时针旋转固定环并将其取下。将其存放在安全的地方。

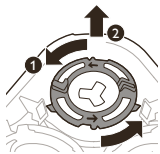



- 5 从剃须刀头支架上卸下剃须刀头。
立即丢弃用过的剃须刀头，以免与新的剃须刀头混淆。

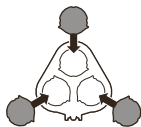

- 6 将新的剃须刀头装到剃须刀头支架中。

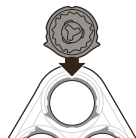

注意：确保剃须刀头的凸缘正好装入剃须刀头支架的凹槽。

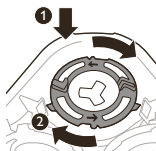

- 7 将固定环放回剃须刀头上，然后顺时针旋转以重新安装固定环。
各固定环均具有两个凹槽和两个凸缘，正好装入剃须刀头支架的凸缘和凹槽内。

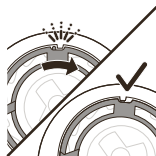

- 顺时针旋转固定环，直至听到“咔哒”一声，表明固定环已就位。

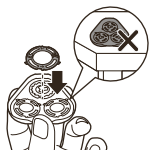

注意：当您重新插入剃须刀头并重新安装固定环时，请将剃须刀头支架握在手中。切勿将剃须刀头支架放在平面上，否则可能会损坏剃须刀头。

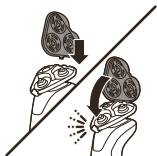

8 将剃须刀头支架的铰链重新卡入剃须刀头部件的槽内。合上剃须刀头支架（可听到“咔哒”一声）。

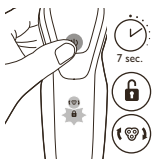

9 要重置更换提醒，请按住开/关按钮约 7 秒钟。

更换洁面刷附件

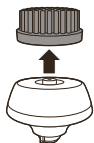

每 3 个月应更换一次刷头，或当刷毛在更短时间内出现弯曲或损坏（请参见‘订购配件’）时更换。

订购配件

如需购买附件或备件，请访问 www.philips.com/parts-and-accessories 或联系您的飞利浦经销商。您还可以联系所在国家/地区的飞利浦客户服务中心（请参阅国际保修卡了解详细联系信息）。
可选配以下附件和备件：

- SH50 飞利浦剃须刀头
- HQ110 飞利浦剃须刀头清洁喷雾剂
- RQ111 飞利浦胡须造型器附件
- RQ585 飞利浦洁面刷附件
- RQ560、RQ563 飞利浦洁面刷头
- JC301、JC302、JC303、JC304、JC305 清洁滤芯
- HQ8505 电源部件

注意：配件可用性可能因国家/地区而异。

回收

- 弃置本产品时，请不要将其与一般生活垃圾放在一起，应将其交给政府指定的回收中心。这样做将有利于环保。
- 此产品包含内置充电电池；请勿将充电电池与一般生活垃圾一起弃置。请您将产品送到官方收集中心或飞利浦服务中心，请专业人士移除充电电池。
- 遵循您的国家/地区有关分类回收电子电气产品和充电电池的规定。正确弃置产品有助于避免对环境和人类健康造成不良后果。

产品中有害物质的名称及含量						
部件名称	有害物质					
	铅 (Pb)	汞 (Hg)	镉 (Cd)	六价铬 (Cr (VI))	多溴联苯 (PBB)	多溴二苯醚 (PBDE)
PCB's 集成电路板	X	O	O	O	O	O
Electrical contact pins 电接触片	X	O	O	O	O	O
Power plug 电源插头	X	O	O	O	O	O
Internal metal parts 内部金属件	X	O	O	O	O	O
本表格依据SJ/T 11364的规定编制。						
O: 表示该有害物质在该部件所有均质材料中的含量均在GB/T 26572规定的限量要求以下。						
X: 表示该有害物质至少在该部件的某一均质材料中的含量超出GB/T 26572规定的限量要求。						

- 该表格中所显示的“有害物质”在产品正常使用情况下不会对人身和环境产生任何伤害。
- 该表格中所显示的“有害物质”及其存在的部件向消费者和回收处理从业者提供相关物质的存在信息，有助于产品废弃时的妥善处理。

卸下剃须刀的充电电池

在废弃器具前，必须将电池从器具中取出。卸下电池之前，请确保本产品与电源断开连接并且电池电量已耗尽。

当您使用工具打开本产品时，请采取必要的安全保护措施。

注意，电池带非常锋利。

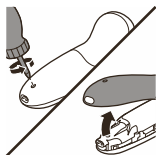

- 1 卸下剃须刀背面的螺钉。
- 2 拆除后面板。

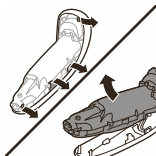

- 3 取出电源部件。

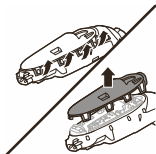

- 4 将安全钩向外掰，取下电源部件的透明保护盖。

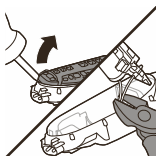

- 5 拉出电池舱，用一把钢丝钳或剪刀将电线剪断。

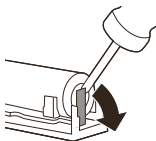

- 6 用钢丝钳或螺丝刀将电池挡片向外掰。
- 7 卸下充电电池。

保修和支持

如需信息或支持，请访问 www.philips.com/support 或阅读国际保修卡。

保修条款

由于剃须刀头（刀片和网罩）属于易磨损物品，因此不在国际保修条款的涵盖范围之列。

故障种类和处理方法

本章归纳了使用本产品时最常见的一些问题。如果您无法根据以下信息解决问题，请访问 www.philips.com/support 查阅常见问题列表，或联系您所在国家/地区的客户服务中心。

剃须刀

问题	可能的原因	解决方法
按下开/关按钮时，产品不工作。	本产品仍然连接着电源插座。出于安全原因，本产品在使用时不能连接充电线。	拔掉产品插头并按开/关按钮打开产品。
	充电电池的电量已耗尽。	给电池充电。
	旅行锁已被激活。	按住开/关按钮 3 秒钟以禁用旅行锁。

问题	可能的原因	解决方法
	剃须刀头部件被污染或损坏，导致马达无法运行。	彻底清洁剃须刀头或将其更换。有关如何彻底清洗剃须刀头的详细说明，另请参阅“毛发或污垢堵塞了剃须刀头”。
产品的剃须效果没有以前好。	剃须刀头已损坏或磨损。	更换剃须刀头。
	毛发或污垢堵塞了剃须刀头。	对剃须刀头进行常规式或彻底清洁。
我更换了剃须刀头，但仍然显示更换提醒。	您尚未重置更换提示。	要重置更换提醒，请按住开/关按钮 7 秒以上。
显示屏上突然出现剃须刀头符号。	此符号是更换提醒。	更换剃须刀头。
水从产品底部漏出。	在清洁过程中，水可能聚集在产品的机身内部与外壳之间。	这是正常现象，而且没有危险，因为所有电子元件都封闭在产品内部的密封电源部件中。

高效智能清洁系统

问题	可能的原因	解决方法
按下开/关按钮时，高效智能清洁系统不工作。	高效智能清洁系统未连接电源插座。	将小插头插入高效智能清洁系统，然后将电源部件插入电源插座。
	清洁滤芯是空的。更换符号闪烁表示您必须更换清洁滤芯。	将新的清洁滤芯放置在高效智能清洁系统中。
剃须刀放在高效智能清洁系统中清洁之后依然没有完全干净。	您未将剃须刀正确插接到高效智能清洁系统，因此高效智能清洁系统和剃须刀之间未通电。	按下顶盖（可听到“咔哒”一声）以确保剃须刀和高效智能清洁系统之间的连接正确无误。
	剃须刀电池的电量不足。	如果剃须刀电池的电量不足，则高效智能清洁系统无法正常工作。剃须刀需要在冲洗阶段短暂开启。使用高效智能清洁系统前，请为剃须刀充电片刻以便清洁剃须刀。
	清洁滤芯需要更换。	更换清洁滤芯。

问题	可能的原因	解决方法
	您使用了其他清洁剂，而不是原装飞利浦清洁滤芯。	只能使用飞利浦原装清洁滤芯。
	清洁滤芯的排水孔堵塞。	从高效智能清洁系统中取出清洁滤芯，然后用牙签推下排水孔的须发。
剃须刀在高效智能清洁系统中无法充满电。	您未将剃须刀正确插接到高效智能清洁系统，因此高效智能清洁系统和剃须刀之间未通电。	按下顶盖（可听到“咔哒”一声）以确保剃须刀和高效智能清洁系统之间的连接正确无误。
问题	可能的原因	解决方法
鼻毛修剪器附件拉拔毛发。	产品移动过快。	缓缓地来回移动附件，以剃掉鼻孔中所有多余的毛发。
鼻毛修剪器附件不工作。	附件的修剪部件非常脏，因为修剪部件内部沾有一些干鼻涕（举个例子）。	在热水龙头下冲洗修剪部件，对其进行清洁。打开产品，再次冲洗修剪部件，以清除任何剩余的毛发。

问题

可能的原因

解决方法

如果在水龙头下冲洗鼻毛修剪器未能疏通修剪部件，请将其浸入盛有温水的玻璃杯中几分钟。然后启动产品，并在水龙头下冲洗。

PHILIPS

产品：飞利浦电动剃须刀
 型号：S5888
 额定电压：220V~
 额定频率：50Hz
 额定输入功率：9W
 生产日期：请见产品本体
 产地：中国广东珠海

IPX4



珠海经济特区飞利浦家庭电器有限公司
 中国珠海市三灶镇琴石工业区
 全国顾客服务热线：4008 800 008

本产品根据国标 GB4706.1-2005,
 GB4706.9-2008制造

PHILIPS

产品：飞利浦电动剃须刀
 型号：S5580
 额定电压：220V~
 额定频率：50Hz
 额定输入功率：9W
 生产日期：请见产品本体
 产地：中国广东珠海



珠海经济特区飞利浦家庭电器有限公司
 中国珠海市三灶镇琴石工业区
 全国顾客服务热线：4008 800 008

本产品根据国标 GB4706.1-2005,
 GB4706.9-2008制造

PHILIPS

产品：飞利浦电动剃须刀
型号：XZ5810, S5570, S5560, S5380, S5370
额定电压：220V~
额定频率：50Hz
额定输入功率：9 W
生产日期：请见产品本体
产地：中国广东珠海



珠海经济特区飞利浦家庭电器有限公司
中国珠海市三灶镇琴石工业区
全国顾客服务热线：4008 800 008

本产品根据国标 GB4706.1-2005, GB4706.9-2008制造

PHILIPS

产品：飞利浦多功能理容电动剃须刀
型号：S5571
额定电压：220V~
额定频率：50Hz
额定输入功率：9 W
生产日期：请见产品本体
产地：中国广东珠海



珠海经济特区飞利浦家庭电器有限公司
中国珠海市三灶镇琴石工业区
全国顾客服务热线：4008 800 008

本产品根据国标 GB4706.1-2005,
GB4706.9-2008制造

PHILIPS

产品：飞利浦电动剃须刀
型号：S5551
额定电压：220V~
额定频率：50Hz
额定输入功率：9W
生产日期：请见产品本体
产地：中国广东珠海

IPX4



珠海经济特区飞利浦家庭电器有限公司
中国珠海市三灶镇琴石工业区
全国顾客服务热线: 4008 800 008

本产品根据国标 GB4706.1-2005,
GB4706.9-2008制造

PHILIPS

产品：飞利浦电动剃须刀
型号：S5530
额定电压：220V~
额定频率：50Hz
额定输入功率：9W
生产日期：请见产品本体
产地：中国广东珠海

IPX4



珠海经济特区飞利浦家庭电器有限公司
中国珠海市三灶镇琴石工业区
全国顾客服务热线: 4008 800 008

本产品根据国标 GB4706.1-2005,
GB4706.9-2008制造

保留备用

发行日期: 7/5/2019

© 2019 Koninklijke Philips N.V.

All rights reserved

保留所有权利

4222.002.5904.8 (7/5/2019)

> 75% 循环再造纸

保留备用



>75 % recycled paper
>75 % papier recyclé