

Register your product and get support at
www.philips.com/welcome

HP8699



User manual

PHILIPS

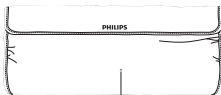
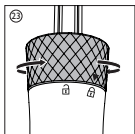
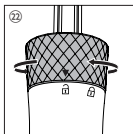
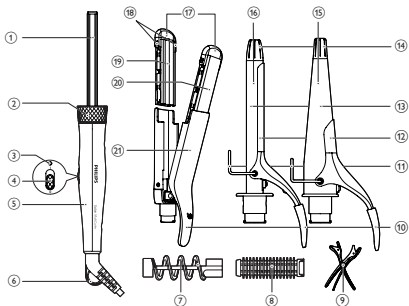

24

2

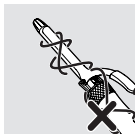
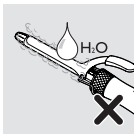

3

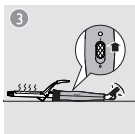
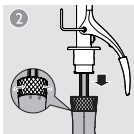

4



5



6

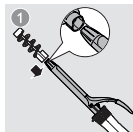

7

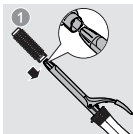

8

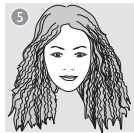
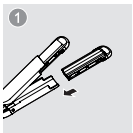



1



2



3



1



2



3



English

Congratulations on your purchase, and welcome to Philips! To fully benefit from the support that Philips offers, register your product at www.philips.com/welcome.

1 Important

Read this user manual carefully before you use the appliance and keep it for future reference.

- **WARNING:** Do not use this appliance near water.
- When the appliance is used in a bathroom, unplug it after use since the proximity of water presents a risk, even when the appliance is switched off.
- **WARNING:** Do not use this appliance near bathtubs, showers, basins or other vessels containing water.
- Always unplug the appliance after use.
- If the mains cord is damaged, you must have it replaced by Philips, a service centre authorised by Philips or



similarly qualified persons in order to avoid a hazard.

- This appliance can be used by children aged from 8 years and above and persons with reduced physical, sensory or mental capabilities or lack of experience and knowledge if they have been given supervision or instruction concerning use of the appliance in a safe way and understand the hazards involved. Children shall not play with the appliance. Cleaning and user maintenance shall not be made by children without supervision.
- Before you connect the appliance, ensure that the voltage indicated on the appliance corresponds to the local power voltage.
- Do not use the appliance for any other purpose than described in this manual.
- When the appliance is connected to the power, never leave it unattended.
- Never use any accessories or parts from other manufacturers or that Philips does not specifically recommend. If you use such accessories or parts, your guarantee becomes invalid.
- Do not wind the mains cord round the appliance.
- Wait until the appliance has cooled down before you store it.

- Pay full attention when using the appliance since it could be extremely hot. Only hold the handle as other parts are hot and avoid contact with the skin.
- Always place the appliance with the stand on a heat-resistant, stable flat surface. The hot heating plates/barrel should never touch the surface or other flammable material.
- Avoid the mains cord from coming into contact with the hot parts of the appliance.
- Keep the appliance away from flammable objects and material when it is switched on.
- Never cover the appliance with anything (e.g. a towel or clothing) when it is hot.
- Only use the appliance on dry hair. Do not operate the appliance with wet hands.
- Keep the heating plates/barrel clean and free of dust and styling products such as mousse, spray and gel.
- The heating plates/barrel has coating. This coating might slowly wear away over time. However, this does not affect the performance of the appliance.
- If the appliance is used on color-treated hair, the heating plates/barrel may be stained. Before using it on artificial hair, always consult their distributor.
- Always return the appliance to a service centre authorized by Philips for examination or repair. Repair by unqualified people could result in an extremely hazardous situation for the user.
- Do not insert metal objects into openings to avoid electric shock.

Electromagnetic fields (EMF)

This appliance complies with all standards regarding electromagnetic fields (EMF). If handled properly and according to the instructions in this user manual, the appliance is safe to use based on scientific evidence available today.

Environment

Your product is designed and manufactured with high quality materials and components, which can be recycled and reused. When this crossed-out wheeled bin symbol is attached to a product it means the product is covered by the European Directive 2012/19/EU.



Please inform yourself about the local separate collection system for electrical and electronic products.

Please act according to your local rules and do not dispose of your old products with your normal household waste. The correct disposal of your old product will help prevent potential negative consequences for the environment and human health.

2 Style your hair

Note: Do not change the attachments or styler when the appliance is heating up or when it is hot. Let the appliance heat up for 3-5 minutes for perfect styling results. When unwinding the section of the hair after curling, do not pull at the hair as it would straighten the curl.

Select a suitable attachment and styler for the hairstyle you want.

Hairstyle	Attachment
Tight curls	Small curling attachment (16)
Modern free flowing curls	Conical curling attachment (15)
Ringlets	Small curling attachment (16) and Slip-on spiral (7)
Waves	Small curling attachment (16) and Slide-on brush (8)

Crimps	Crimping/straightening attachment (21) with curved surfaces (19) facing towards each other
--------	--

Straight sleek style and flicks	Crimping/straightening attachment (21) with flat surfaces (20) facing towards each other
---------------------------------	--

Before you style your hair:

- 1 Ensure arrow on the ring is pointing at unlock icon on the handle (22).
- 2 Slide a suitable attachment onto the metal tube (1) of the handle (5) and turn the ring to the right/anti-clockwise to lock it (23).
 - To remove the attachment, turn the ring to the left/clockwise to unlock (22) and pull it off.
- 3 Connect the plug to a power supply socket.
- 4 Slide the on/off switch (4) to I to switch on the appliance.
 - ↳ The power-on indicator (3) lights up and starts blinking.
 - ↳ When the appliance is ready for use, the indicator stops blinking.
- 5 Place the appliance with the support (11) on a heat-resistant surface.
- 6 Comb your hair and divide your hair into small sections that are not wider than 2-4cm.

Create curls or ringlets (Fig.4)

- 1 Select small curling attachment (16) for styling tight curls and ringlets.
- 2 Press the lever (10) to open the clip (12) and place a section of hair between the clip and barrel (13).
 - If you use the Slip-on spiral attachment (7) to create ringlets, wind the section of hair round the barrel following the spiral profile. (Fig.6)
- 3 Release the lever and slide the barrel to the hair tip.

- 4 Hold the end of the cool tip (⑭) and the handle (⑤). Then wind the section of hair round the barrel from end to root.
- 5 Hold the barrel in the position for max. 10 seconds. Then unwind the section of hair until you can open the clip again with the lever or until you can remove the spiral from your hair.
- 6 To style the rest of your hair; repeat steps 2 to 5.

Create free-flowing, modern curls (Fig.5)

- 1 Select conical curling attachment (⑮) for styling large curls.
- 2 Press the lever (⑩) to open the clip (⑫) and place a section of hair between the clip and conical barrel (⑬).
- 3 Release the lever and slide the barrel to the hair tip.
- 4 Hold the end of the cool tip (⑭) and the handle (⑤). Then wind the section of hair round the barrel from end to root.
- 5 Hold the barrel in the position for max. 10 seconds, and then unwind the section of hair until you can remove the conical barrel from your hair.
- 6 To style the rest of your hair; repeat steps 2 to 5.

Create waves (Fig.7)

- 1 Select the small curling attachment. Then slide the Slide-on brush (⑧) onto barrel.
- 2 Wind a section of hair round the brush.
- 3 Hold the barrel in the position for max. 10 seconds. Then unwind the section of hair to remove the Slide-on brush (⑧) from your hair.
- 4 To style the rest of your hair; repeat steps 2-3.

Create crimps (Fig.8)

- 1 Select crimping/straightening attachment (⑳). Make sure that the curved surfaces (⑲) are facing each other.
 - To remove the the crimping/straightening plates, grab each protruded side of the plate (⑱) and pull it off until it cools down.
- 2 Press the lever (⑩) to open the attachment and place a section of hair between the crimping plates.

- 3 Release the lever and keep the plates together for 5 to 10 seconds.
- 4 Press the lever to open the plates and place the next section of hair between the plates. Make sure there is an overlap.
- 5 Repeat this process until you have reached the hair tip.
- 6 To style the rest of your hair; repeat steps 2 to 5.

Create straight sleek style and flicks (Fig.9)

- 1 Make sure that the flat surfaces (20) are facing each other. Press the lever (10) to open the attachment and place a section of hair between the straightening plates.
- 2 Slide down slowly the length of the hair in a single motion (max. 5 seconds) from root to end, without stopping to prevent overheating.
 - To create your desired type of flick, turn the styler half-circle inwards (or outwards) when it reaches the last 3-5 cm of the hair tip. Hold in that position for 2 to 3 seconds, and then release it.
- 3 To style the rest of your hair; repeat steps 1 to 2.

Note: The appliance is equipped with an auto-shut off function. After 60 minutes, the appliance switches off automatically. You can re-start the appliance by sliding the ON/OFF switch to | to power on the styler again.

After use:

- 1 Switch off the appliance and unplug it.
- 2 Place it on a heat-resistant surface until it cools down.
- 3 Remove hairs and dust from the appliance and attachments.
- 4 Clean the appliance and attachments by damp cloth.
- 5 Keep the appliance in a safe and dry place, free of dust. You can also hang it with the hanging loop (6) or store it in the supplied heat resistant pouch (24).

3 Guarantee and service

If you need information e.g. about replacement of an attachment or if you have a problem, please visit the Philips website at www.philips.com or contact the Philips Customer Care Centre in your country (you find its phone number in the worldwide guarantee leaflet). If there is no Consumer Care Centre in your country, go to your local Philips dealer.



Specifications are subject to change without notice
© 2013 Koninklijke Philips N.V.
All rights reserved.



3140 035 33131