

**PHILIPS**

S586, S566



© 2017 Koninklijke Philips N.V.  
All rights reserved  
4222.002.7320.1 (23/5/2017)



 >75% recycled paper  
>75% papier recyclé

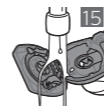
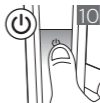
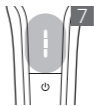
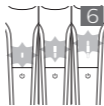
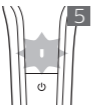
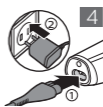

Congratulations on your purchase and welcome to Philips! To fully benefit from the support that Philips offers, register your product at [www.philips.com/welcome](http://www.philips.com/welcome).

## General description (Fig. 1)

- 1 Protection cap
  - 2 Shaving head holder
  - 3 Shaving unit connector
  - 4 Handle
  - 5 Battery charge indicator
  - 6 On/off button
  - 7 Socket for small plug
  - 8 Cutter
  - 9 Guard
  - 10 Retaining frame
  - 11 Supply unit
  - 12 Small plug
- Not shown: cleaning brush

## Important safety information

Read this important information carefully before you use the

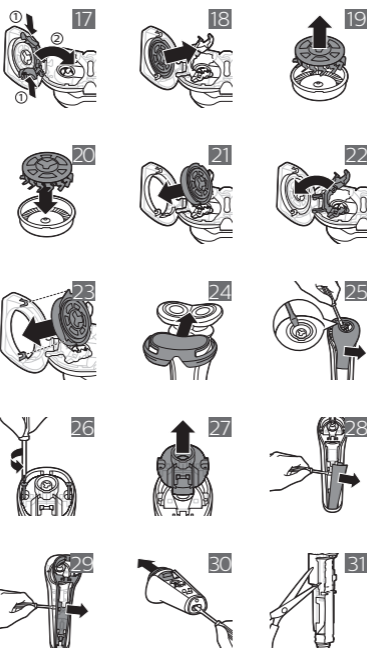
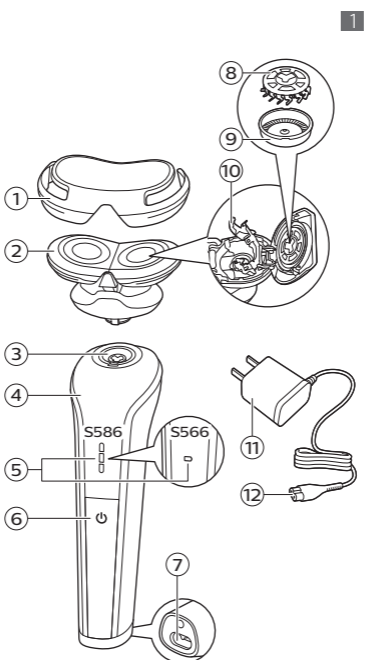

appliance and its accessories and save it for future reference. The accessories supplied may vary for different products.

### **Danger**

- Keep the supply unit dry (Fig. 2).

### **Warning**

- To charge the battery, only use the detachable supply unit (HQ8505) provided with the appliance.
- The supply unit contains a transformer. Do not cut off the supply unit to replace it with another plug, as this causes a hazardous situation.
- This appliance can be used by children aged from 8 years and above and persons with reduced physical, sensory or mental capabilities or lack of experience and knowledge if they have been given supervision or instruction concerning use of the appliance in a safe way and understand the hazards involved. Children shall not play with the appliance. Cleaning and user maintenance shall not be made by children without supervision.
- Always unplug the shaver before you clean it under the tap.
- Always check the appliance before you use it. Do not use the appliance if it is damaged, as this may cause injury. Always replace a damaged part with one of the original type.
- Do not open the appliance to replace the rechargeable battery.

### **Caution**

- Never use water hotter than 60°C to rinse the shaver.
- Only use this appliance for its intended purpose as shown in the user manual.
- For hygienic reasons, the appliance should only be used by one person.
- Never use compressed air, scouring pads, abrasive cleaning agents or aggressive liquids such as petrol or acetone to clean the appliance.
- Water may drip from the bottom of the shaver when you rinse it. This is normal and not dangerous because all electronics are enclosed in a sealed power unit inside the shaver.
- Do not use the supply unit in or near wall sockets that contain an electric air freshener to prevent irreparable damage to the supply unit.

### **Electromagnetic fields (EMF)**

- This Philips appliance complies with all applicable standards and regulations regarding exposure to electromagnetic fields.

### **General**

- This shaver is waterproof (Fig. 3). It is suitable for use in the bath or shower and for cleaning under the tap. For safety reasons, the shaver can therefore only be used without cord.
- The appliance is suitable for mains voltages ranging from 100 to 240 volts.
- The supply unit transforms 100-240 volts to a safe low voltage of less than 24 volts.

## Charging

Note: This appliance can only be used without cord.

Charge the appliance before first use and when the display indicates that the battery is almost empty.

Charging takes approx. 1 hour. A fully charged shaver provides up to 45 minutes of shaving time.

### Charging with the supply unit

- 1 Put the small plug in the shaver.
- 2 Put the supply unit in the wall socket (Fig. 4).
- 3 After charging, remove the supply unit from the wall socket and pull the small plug out of the appliance.

### Charge indications

#### Battery low

S586: When the battery is almost empty, the bottom light of the battery charge indicator flashes orange (Fig. 5).

S566: When the battery is almost empty, the battery charge indicator flashes orange.

#### Battery charging

S586: When the appliance is charging, the bottom light of the battery charge indicator first flashes and then lights up continuously (Fig. 6). After this the second light flashes and then lights up continuously, and so on until the appliance is fully charged.

S566: When the appliance is charging, the battery charge indicator flashes white.

#### Battery full

S586: When the battery is fully charged, all lights of the battery charge indicator light up white continuously (Fig. 7).

S566: When the battery is fully charged, the battery charge indicator lights up white continuously.

Note: This appliance can only be used without cord.

#### 'Unplug before use' reminder

S586: All lights of the battery charge indicator flash 3 times to remind you to unplug the shaver first.

S566: The battery charge indicator flashes fast briefly to remind you to unplug the shaver first.

## Using the appliance

### Removing or attaching the click-on attachments

- 1 Make sure the appliance is switched off.
- 2 Insert the lug of the attachment into the slot in the top of the appliance. Then press down the attachment to attach it to the appliance ('click') (Fig. 8).
- 3 Pull the attachment straight off the appliance (Fig. 9).

Note: Do not twist the attachment while you pull it off the appliance.

### Switching the appliance on and off

- 1 To switch the appliance on or off, press the on/off button once (Fig. 10).

### Skin adaptation period

Your first shaves may not bring you the result you expect and your skin may even become slightly irritated. This is normal. Your skin and beard need time to adapt to any new shaving system. To allow your skin to adapt to this new appliance, we

advise you to shave regularly (at least 3 times a week) and exclusively with this appliance for a period of 3 weeks.

Note: This appliance can only be used without cord.

## Shaving

### Dry shaving

- 1 Switch on the appliance.
- 2 Move the shaving heads over your skin in circular movements to catch all hairs growing in different directions (Fig. 11). Exert gentle pressure for a close, comfortable shave.

Note: Do not press too hard, as this can cause skin irritation.

- 3 Clean the appliance after use (see 'Cleaning and maintenance').

### Wet shaving

For a more comfortable shave, you can also use this appliance on a wet face with shaving foam or shaving gel.

To shave with shaving foam or shaving gel, follow the steps below:

- 1 Apply some water to your skin.
- 2 Apply shaving foam or shaving gel to your skin.
- 3 Rinse the shaving unit under the tap to ensure that the shaving unit glides smoothly over your skin.
- 4 Switch on the appliance.
- 5 Move the shaving heads over your skin in circular movements to catch all hairs growing in different directions (Fig. 11). Exert gentle pressure for a close, comfortable shave.

Note: Do not press too hard, this can cause skin irritation.

Note: Rinse the shaving unit regularly to ensure that it continues to glide smoothly over your skin.

- 6 Dry your face.
- 7 Clean the appliance after use (see 'Cleaning and maintenance').

Note: Make sure you rinse all foam or shaving gel off the appliance.

## Cleaning and maintenance

### Cleaning the shaver under the tap

Clean the shaver after every shave for optimal performance (see 'Cleaning and maintenance'). Always unplug and switch off the shaver before you clean it.

**Never use compressed air, scouring pads, abrasive cleaning agents or aggressive liquids such as petrol or acetone to clean the appliance.**

**Be careful with hot water. Always check if the water is not too hot, to prevent burning your hands.**

**Never dry the shaving unit with a towel or tissue, as this may damage the shaving heads.**

- 1 Rinse the shaving unit under a warm tap.  
Note: You can also clean the shaving unit with the cleaning brush supplied (Fig. 12).
- 2 Turn the shaver up side down and rinse the openings in the bottom of the shaving head holders. Switch on the shaver briefly during rinsing (Fig. 13).
- 3 Open both shaving head holders (Fig. 14).

- 4 Rinse the hair chambers and shaving head holders under the tap (Fig. 15).
- 5 Carefully shake off excess water and let air dry completely.
- 6 Close the shaving head holders (Fig. 16).

### Thorough cleaning

The shaving unit consists of two shaving heads. Clean one shaving head at a time by following the steps below.

- 1 Open the shaving head holder (Fig. 14).
- 2 To unlock the retaining frame, gently squeeze both sides of the retaining frame and flip open the frame (Fig. 17).
- 3 Remove the shaving head. Each shaving head consists of a cutter and a guard (Fig. 18).

Note: Do not clean more than one cutter and guard at a time, since they are all matching sets. If you accidentally mix up the cutters and guards, it may take several weeks before optimal shaving performance is restored.

- 4 Remove the cutter from the shaving guard (Fig. 19).
- 5 Rinse both parts with water.
- 6 After cleaning, place the cutter back into the guard with the cutter legs pointing downwards (Fig. 20).
- 7 Put the shaving head back into the shaving head holder (Fig. 21).

Note: Make sure that the shaving heads with the projections fit exactly onto the hooks of the shaving head holder when placing them (Fig. 23). The shaving heads supplied with this appliance either have notches or projections. Both shaving systems are the same.

- 8 Push the retaining frame back onto the shaving head holder until you hear a click (Fig. 22).
- 9 Close the shaving head holder (Fig. 16).

### Replacement

#### Replacing the shaving heads

For maximum shaving performance, we advise you to replace the shaving heads every two years. Replace damaged shaving heads immediately. Always replace the shaving heads with original Philips shaving heads (see 'Ordering accessories').

- 1 Switch off the appliance.
- 2 Open the shaving unit by opening both shaving head holders (Fig. 14).
- 3 To unlock the retaining frames, gently squeeze both sides of the retaining frames and flip open the shaving heads (Fig. 17).
- 4 Remove the shaving heads from the shaving head holders (Fig. 18). Throw away the used shaving heads immediately to avoid mixing them with the new shaving heads.
- 5 Place the new shaving heads in the shaving head holders.

Note: Make sure that the shaving heads with the projections fit exactly onto the hooks of the shaving head holder when placing them (Fig. 23). The shaving heads supplied with this appliance either have notches or projections. Both shaving systems are the same.

- 6 Push the retaining frames back onto the shaving head holder until you hear a click (Fig. 22).

- 7 Close the shaving head holders (Fig. 16).

## Storage

Always slide the protection cap onto the shaving unit to protect the shaving unit from dirt or damage during traveling or storage (Fig. 24). We advise you to let the appliance dry before you store it.

## Ordering accessories

To buy accessories or spare parts, visit [www.shop.philips.com/service](http://www.shop.philips.com/service) or go to your Philips dealer. You can also contact the Philips Consumer Care Center in your country (see the international warranty leaflet for contact details).

## Available parts

The following accessories and spare parts are available:

- SH30 Philips shaving heads
- RQ575 Philips cleansing brush attachment
- RQ563 Philips cleansing brush attachment 3-pack
- HQ110 Cleaning spray
- HQ8505 supply unit

Note: Availability of the accessories may differ by country.

## Recycling

- Do not throw away the product with the normal household waste at the end of its life, but hand it in at an official collection point for recycling. By doing this, you help to preserve the environment.
- This product contains a built-in rechargeable battery which shall not be disposed of with normal household waste. We strongly advise you to take your product to an official collection point or a Philips service centre to have a professional remove the rechargeable battery.
- Follow your country's rules for the separate collection of electrical and electronic products and rechargeable batteries. Correct disposal helps prevent negative consequences for the environment and human health.

## Removing the rechargeable battery

**Only remove the rechargeable battery when you discard the shaver. Before you remove the battery, make sure that the shaver is disconnected from the mains and that the battery is completely empty.**

**Take any necessary safety precautions when you handle tools to open the shaver.**

Be careful, the battery strips are sharp.

- 1 Disconnect the appliance from the wall socket and let the appliance run until the motor stops.
- 2 Insert a screwdriver under the edge of the upper front panel and remove it (Fig. 25).
- 3 Undo the screws in the top part of the shaver (Fig. 26).
- 4 Remove the cover (Fig. 27).
- 5 Insert a screwdriver under the edge of the lower front panel to remove it (Fig. 28).
- 6 Remove the inner panel with a screwdriver (Fig. 29).

- 7 Push the inner frame out of the housing with the screwdriver (Fig. 30).
- 8 Cut the wires from the motor with pliers (Fig. 31) and remove the printed circuit board (Fig. 32).
- 9 Break the battery tags and remove the batteries (Fig. 33).

## Troubleshooting

This chapter summarizes the most common problems you could encounter with the appliance. If you are unable to solve the problem with the information below, visit [www.philips.com/support](http://www.philips.com/support) for a list of frequently asked questions or contact the Consumer Care Center in your country.

Problem	Possible cause	Solution
The shaver does not work as well as it used to.	The shaving heads are damaged or worn.	Replace the shaving heads (see 'Replacement').
	The shaving heads are dirty.	Clean the shaving heads (see 'Cleaning and maintenance').
	Long hairs obstruct the shaving heads.	Clean the shaving heads (see 'Cleaning and maintenance').
The shaver does not work when I switch it on.	The rechargeable battery is low.	Switch off the shaver and recharge the battery (see 'Charging').
	The rechargeable battery is empty.	Switch off the shaver and recharge the battery (see 'Charging').
The shaving heads do not stay in place in the shaving unit.	The shaver is connected to the wall socket.	This appliance can only be used without cord. Remove the supply unit from the wall socket and pull the small plug out of the appliance.
	You did not fix the retaining frames properly.	The retaining frames are fixed properly if you hear a click when you push it back onto the shaving heads.
	The shaving heads with projections are not placed properly.	Make sure that the shaving heads with the projections fit exactly onto the hooks of the shaving head holder when placing them (Fig. 23).



感謝您購買本產品。歡迎來到飛利浦的世界！為充分享受飛利浦為您提供的好處，請至下列位址註冊產品：[www.philips.com/welcome](http://www.philips.com/welcome)。

## 一般說明 (圖 1)

- 1 保護蓋
  - 2 電鬚刀刀頭固定座
  - 3 電鬚刀組接頭
  - 4 握把
  - 5 電池充電指示燈
  - 6 開關按鈕
  - 7 小插頭插座
  - 8 刀具
  - 9 刀網
  - 10 固定架
  - 11 電源供應裝置
  - 12 小插頭
- 未顯示：清潔刷

## 重要安全資訊

使用本產品與其配件前，請先仔細閱讀此重要資訊，並保留說明以供日後參考。提供的配件可能隨產品而異。

### 危險

- 電源供應裝置請保持乾燥 (圖 2)。

### 警示

- 如需為電池充電，僅可使用裝置隨附的可拆式電源供應裝置 (型號：HQ8505)。
- 電源供應裝置內含一個變壓器。請勿切斷電源供應裝置而以其他的插頭取代，否則會造成危險。
- 本產品可供 8 歲以上兒童、身體官能或心智能力退化者，或是經驗與使用知識缺乏者使用，但需有人從旁監督或指示如何安全使用本產品，且使用者需了解使用本產品的潛在危險。請勿讓小孩把玩本產品。若無人監督，請勿讓兒童進行清潔和使用者維護。
- 在水龍頭下沖洗電鬚刀之前，請先拔掉電鬚刀的插頭。
- 使用前請務必檢查本產品。若產品受損請勿使用，以免受傷。零件如有受損，請務必以原型號更換之。
- 請勿拆開本產品更換充電式電池。

### 警告

- 切勿使用超過 60° C 的熱水沖洗電鬚刀。
- 本產品儘限用於本使用手冊所述之相關用途。
- 為保衛生起見，請勿多人共用本產品。
- 絕對不可使用壓縮空氣、鋼絲絨、磨蝕性的清潔劑或侵蝕性的液體 (例如汽油或丙酮) 清潔本產品。
- 在您沖洗時，電鬚刀底部的插孔可能會滴水。此為正常現象，並不會造成危險，因為所有的電子零件都密封於電鬚刀內的電力裝置中。
- 請勿在插入電子空氣清淨機的牆壁插座內或附近使用電源供應裝置，以免電源供應裝置發生無法修復的損壞。

## 電磁波 (EMF)

- 本Philips產品符合所有電磁場暴露的相關適用標準和法規。

## 一般

- 此電鬚刀防水 (圖 3)。適合在泡澡或淋浴時使用，並可在水龍頭下清潔。因此為了安全起見，此電鬚刀只能以無線方式操作。
- 本產品適用於 100 到 240 伏特的插座電壓。
- 電源供應裝置可以將 100-240 伏特的電壓轉換為低於 24 伏特的安全低電壓。

## 充電

注意：本產品只能以無線方式使用。

請在初次使用之前、螢幕指顯示電池電量即將用盡時，為產品充電。

充電時間約需 1 小時。充飽電的電鬚刀最多可使用 45 分鐘。

## 使用電源供應裝置充電

- 1 將小插頭插上電鬚刀。
- 2 將電源供應裝置插入牆上插座 (圖 4)。
- 3 充電完畢請將電源供應裝置拔離電源插座，並將小插頭從產品上拔除。

## 充電指示

### 電量不足

S586：電池電力即將用盡時，最下方的電池充電指示燈會閃爍橘光 (圖 5)。

S566：電池電力即將用盡時，電池充電指示燈會閃爍橘光。

### 電池充電中

S586：本產品充電時，最下方的電池充電指示燈會先閃爍，然後持續 (圖 6) 亮起。然後第二個指示燈先閃爍，繼而持續發光，依此類推直到產品充飽電為止。

S566：本產品充電時，電池充電指示燈會閃爍白光。

### 電量已滿

S586：當電池充飽電後，所有電池充電指示燈都會持續 (圖 7) 亮白光。

S566：電池充飽電後，電池充電指示燈會持續亮白光。

## 使用本產品

注意：本產品只能以無線方式使用。

### 「使用前拔除插頭」提醒

S586：電池充電指示燈的所有燈將閃爍 3 次，提醒您先拔除電鬚刀插頭。

S566：電池充電指示燈將快速短暫地閃爍，提醒您先拔除電鬚刀插頭。

## 使用本產品

### 拆下或裝上嵌入式配件

- 1 確定關閉本產品的電源。
- 2 將配件的突耳插入本產品頂端的凹槽。再將配件往下壓，即可安裝到本產品上 (會聽見「喀嗒」一聲) (圖 8)。
- 3 直接從產品 (圖 9) 取下配件。

注意：當您將配件從產品取下時，請勿扭轉。

### 開啟及關閉本產品

- 1 若要開啟或關閉本產品電源，請按一下 (圖 10) 開關按鈕。

### 皮膚適應期

您第一次刮鬚的結果可能不如您所預期，皮膚甚至可能稍微刺痛。這是正常現象。您的皮膚與鬚鬚需要時間適應新的刮鬚系統。建議您用這把電鬚刀定期刮鬚 (每週至少 3 次) 為期 3 週，讓您的肌膚適應新的電鬚刀。

## 使用本產品

注意：本產品只能以無線方式使用。

### 刮鬚

#### 乾刮

- 1 開啟產品電源。
- 2 將電鬚刀刀頭在皮膚上以畫圓方式移動，以清除所有不同方向 (圖 11) 生長的毛髮。稍微下壓，享受服貼舒適的刮鬚體驗。

注意：請勿按壓太用力，否則可能造成皮膚刺痛。

- 3 使用後需清潔本產品。

#### 濕刮

您也可以在沾有刮鬚泡或刮鬚凝露的濕潤面部上使用本產品。

若要在刮鬚時配合使用刮鬚泡或刮鬚凝膠，請依照下列步驟：

- 1 在皮膚上抹一點水。
- 2 將刮鬚泡或刮鬚凝膠抹到皮膚上。
- 3 將電鬚刀組放在水龍頭下沖洗，以確保電鬚刀組能在皮膚上平順移動。
- 4 開啟產品電源。
- 5 將電鬚刀刀頭在皮膚上以畫圓方式移動，以清除所有不同方向 (圖 11) 生長的毛髮。稍微下壓，享受服貼舒適的刮鬚體驗。

注意：請勿按壓太用力，否則可能造成皮膚刺痛。

注意：請定期沖洗電鬚刀組，以確保電鬚刀可持續在皮膚上平順移動。

- 6 將臉部擦乾。
- 7 使用後需清潔本產品。

注意：請確實從本產品上洗去所有刮鬚泡或刮鬚凝膠。

## 清潔與維護

### 將電鬚刀放在水龍頭下沖洗

為達到最佳性能 (見 '清潔與維護')，請於每回刮鬚之後清潔電鬚刀。清潔電鬚刀之前請務必將電鬚刀自插座中拔出並關閉電源。

絕對不可使用壓縮空氣、鋼絲絨、磨蝕性的清潔劑或侵蝕性的液體 (例如汽油或丙酮) 清潔本產品。

警告：使用熱水時請小心。隨時檢查熱水是否太燙，以避免手部燙傷。

切勿使用毛巾或紙巾擦乾電鬚刀組，否則可能會造成電鬚刀刀頭損壞。

- 1 將電鬚刀組以溫水沖洗。  
注意：您也可以使用產品所附 (圖 12) 的清潔刷清潔電鬚刀組。
- 2 將電鬚刀上下顛倒，沖洗電鬚刀刀頭固定座底部的開口。在沖洗 (圖 13) 期間短暫開啟電鬚刀電源。
- 3 打開兩個電鬚刀刀頭固定座 (圖 14)。
- 4 將鬚渣室及電鬚刀刀頭固定座放在水龍頭 (圖 15) 下沖洗。
- 5 仔細甩乾多餘的水份之後，使其完全風乾。
- 6 關上電鬚刀刀頭固定座 (圖 16)。

### 徹底清潔

電鬚刀組包含兩個電鬚刀刀頭。請遵循下列步驟，一次清潔一個電鬚刀刀頭。

- 1 打開電鬚刀刀頭固定座 (圖 14)。
- 2 如欲打開固定架，請輕輕地擠壓固定架兩側，然後翻開固定架 (圖 17)。
- 3 取下刀頭。每個電鬚刀刀頭都是由刀具和刀網 (圖 18) 組成。

注意：刀具及刀網是成對組合，請勿一次清潔超過一組。如果您不小心將刀具及刀網混在一起，可能要花幾週的時間才能恢復最理想的刮鬚效果。

- 4 從電鬚刀刀網 (圖 19) 上取下刀片。
- 5 使用清水沖洗這兩個零件。
- 6 清潔後，請將刀片放回刀網，使刀片腳朝下 (圖 20)。
- 7 將電鬚刀刀頭裝回電鬚刀刀頭固定座 (圖 21)。

注意：確定電鬚刀刀頭的凸出部分 (圖 23) 在放入電鬚刀刀頭固定座時，完全精準地嵌入固定座的鉤子。本產品隨附的電鬚刀刀頭具有溝槽或凸出部分。兩種電鬚刀系統是相同的。

- 8 將固定架放回電鬚刀刀頭固定座，直到聽見喀 (圖 22) 一聲。
- 9 關上電鬚刀刀頭固定座 (圖 16)。

## 更換

### 更換電鬚刀刀頭

為達到最佳刮鬚性能，我們建議您每兩年更換一次電鬚刀刀頭。刀頭若受損，請立即更換。更換電鬚刀刀頭時，請務必使用原廠飛利浦電鬚刀刀頭 (見 '訂購配件')。

- 1 關閉產品電源。
- 2 打開兩個電鬚刀刀頭固定座 (圖 14)，以便打開電鬚刀組。
- 3 如欲打開固定架，請輕輕地擠壓固定架兩側，然後翻開電鬚刀刀頭 (圖 17)。
- 4 從電鬚刀刀頭固定座 (圖 18) 上取下電鬚刀刀頭。  
請立即丟棄用過的刀頭，以免與新的刀頭混用。
- 5 將新的電鬚刀刀頭裝回電鬚刀刀頭固定座。

注意：確定電鬚刀刀頭的凸出部分 (圖 23) 在放入電鬚刀刀頭固定座時，完全精準地嵌入固定座的鉤子。本產品隨附的電鬚刀刀頭具有溝槽或凸出部分。兩種電鬚刀系統是相同的。

- 6 將固定架放回電鬚刀刀頭固定座，直到聽見喀 (圖 22) 一聲。
- 7 關上電鬚刀刀頭固定座 (圖 16)。

## 存放

請務必以滑動方式蓋上電鬚刀組的保護蓋，避免電鬚刀組在旅行或收納 (圖 24) 期間沾附塵土或損壞。

我們建議您待本產品乾燥後，再收納起來。

## 訂購配件

若要購買配件或備用零件，請造訪 [www.shop.philips.com/service](http://www.shop.philips.com/service)，或洽詢您的飛利浦經銷商。您也可以聯絡您所在國家/地區的飛利浦客戶服務中心 (詳細聯絡資料請參閱全球保證書)。

## 可用零件

備有下列配件及備用零件可供另外選購：

- SH30 飛利浦電鬚刀頭
- RQ575 飛利浦潔顏刷配件
- RQ563 飛利浦潔顏刷配件 3 組
- HQ110 噴霧清潔劑
- HQ8505 電源供應裝置

注意：各國家/地區供應的配件可能有所不同。

## 回收

- 本產品使用壽命結束時請勿與一般家庭廢棄物一併丟棄。請將該產品放置於政府指定的回收站，此舉能為環保盡一份心力。
- 本產品包含內建充電式電池，不得與一般家用廢棄物一併丟棄。強烈建議您將產品攜至政府指定的回收站或 Philips 服務中心，由專業人員取出充電式電池。
- 請按照您所在國家/地區的規定，分類與回收電子電器產品及充電式電池。正確處理廢棄產品有助於避免對環境和人類健康帶來負面影響。

## 取出充電式電池

請僅在棄置電鬚刀前取出充電式電池。取出電池前，請確認已拔除電鬚刀的電源插頭，且電池電力已完全耗盡。

使用工具打開電鬚刀時，請採取任何必要的安全預防措施。

電池固定帶非常銳利，請小心。

- 1 將產品從電源插座拔除，讓產品一直運作直到馬達停止。
- 2 將螺絲起子插入上方正面護板邊緣的底下，將其拆下 (圖 25)。
- 3 拆下電鬚刀 (圖 26) 頂部的螺絲。
- 4 取下蓋子 (圖 27)。
- 5 將螺絲起子插入下方正面護板邊緣的底下，將其 (圖 28) 拆下。
- 6 使用螺絲起子 (圖 29) 拆下內護板。
- 7 使用螺絲起子 (圖 30) 將內框架推出外殼。
- 8 使用鉗子 (圖 31) 剪斷馬達電線，然後拆下印刷電路板 (圖 32)。
- 9 折斷電池拉片並取出電池 (圖 33)。

## 疑難排解

本章概述了使用本產品最常遇到的問題。如果無法利用以下資訊解決遇到的問題，請造訪 [www.philips.com/support](http://www.philips.com/support) 瀏覽常見問題清單，或聯絡您所在國家/地區的飛利浦客戶服務中心。

問題	可能原因	解決方法
----	------	------

電鬚刀不像平常一樣運作。	電鬚刀刀頭毀壞或磨損。	更換刀頭 (見 '更換')。
--------------	-------------	----------------

問題	可能原因	解決方法
	電鬚刀刀頭有髒汗。	清潔刀頭 (見 '清潔與維護')。
	長鬚鬚卡住電鬚刀刀頭。	清潔刀頭 (見 '清潔與維護')。
	充電式電池電力不足。	關閉電鬚刀電源，並將電池 (見 '充電') 充電。
開啟產品電源時，電鬚刀無法使用。	充電式電池沒電。	關閉電鬚刀電源，並將電池 (見 '充電') 充電。
	電鬚刀已連接至插座。	本產品只能以無線方式使用。請將電源供應裝置拔離電源插座，並將小插頭從產品上拔除。
電鬚刀組中的電鬚刀刀頭不穩固。	固定架未妥善固定。	如果您在將固定架推回電鬚刀刀頭時聽見喀一聲，就表示固定架已適當固定。
	電鬚刀刀頭的凸出部分未正確安裝。	確定電鬚刀刀頭的凸出部分 (圖 23) 在放入電鬚刀刀頭固定座時，完全精準地嵌入固定座的鉤子。