

**PHILIPS**

AC4372, AC4374



EN User Manual 3

ZH-TW 使用手冊 25



# Contents

<b>1 Important</b>	4	<b>10 Notices</b>	23
Safety	4	Electromagnetic fields (EMF)	23
		Recycling	24
<b>2 Your air purifier</b>	7		
Overview (for AC4372)	7		
Overview (for AC4374)	8		
<b>3 Get started</b>	9		
Install filters	9		
<b>4 Use the air purifier</b>	11		
Understand the air quality light	11		
Switch on	11		
Set the sensitivity of the air quality sensor	12		
Select the fan speed	13		
Set the timer	13		
Activate child lock	13		
Night mode	14		
<b>5 Clean your air purifier</b>	14		
Clean the air purifier	14		
Clean the air quality sensor	15		
<b>6 Clean the pre-filter</b>	16		
<b>7 Replace the filters</b>	17		
Reset filter lock	20		
<b>8 Troubleshooting</b>	21		
<b>9 Guarantee and service</b>	23		
Order parts or accessories	23		

# 1 Important

---

## Safety

Read this user manual carefully before you use the appliance, and save it for future reference.

## Danger

- Do not let water or any other liquid or flammable detergent enter the appliance to avoid electric shock and/or a fire hazard.
- Do not clean the appliance with water, any other liquid, or a (flammable) detergent to avoid electric shock and/or a fire hazard.

## Warning

- Check if the voltage indicated on the bottom or indicated at the rear of the appliance corresponds to the local power voltage before you connect the appliance.
- If the power cord is damaged, you must have it replaced by Philips, a service center authorized

by Philips, or similarly qualified persons in order to avoid a hazard.

- Do not use the appliance if the plug, the power cord, or the appliance itself is damaged.
- This appliance can be used by children aged from 8 years and above and persons with reduced physical, sensory or mental capabilities or lack of experiences and knowledge if they have been given supervision or instruction concerning use of the appliance in a safe way and understand the hazards involved. Children shall not play with the appliance. Cleaning and user maintenance shall not be made by children without supervision.
- Do not block the air inlet and outlet, e.g. by placing items on the air outlet or in front of the air inlet.

## Caution

- This appliance is not a substitute for proper ventilation, regular vacuum cleaning, or use of an extractor hood or fan while cooking.
- If the power socket used to power the appliance has poor connections, the plug of the appliance becomes hot. Make sure that you plug the appliance into a properly connected power socket.
- Always place and use the appliance on a dry, stable, level, and horizontal surface.
- Leave at least 20cm free space behind and on both sides of the appliance and leave at least 30cm free space above the appliance.
- Do not place anything on top of the appliance and do not sit on the appliance.
- Do not place the appliance directly below an air conditioner to prevent condensation from dripping onto the appliance.
- Make sure all filters are properly installed before you switch on the appliance.
- Only use the original Philips filters specially intended for this appliance. Do not use any other filters.
- Avoid knocking against the appliance (the air inlet and outlet in particular) with hard objects.
- Do not insert your fingers or objects into the air outlet.
- Do not use this appliance when you have used indoor smoke-type insect repellents or in places with oily residues, burning incense, or chemical fumes.
- Do not use the appliance near gas appliances, heating devices or fireplaces.
- Always unplug the appliance after use and before you clean it.

- Do not use the appliance in a room with major temperature changes, as this may cause condensation inside the appliance.
- To prevent interference, place the appliance at least 2m away from electrical appliances that use airborne radio waves such as TVs, radios, and radio-controlled clocks.
- The appliance is only intended for household use under normal operating conditions.
- Do not use the appliance in wet surroundings or in surroundings with high ambient temperatures, such as the bathroom, toilet, or kitchen.
- The appliance does not remove carbon monoxide (CO) or radon (Rn). It cannot be used as a safety device in case of accidents with combustion processes and hazardous chemicals.

## 2 Your air purifier

Congratulations on your purchase, and welcome to Philips!

To fully benefit from the support that Philips offers, register your product at [www.Philips.com/welcome](http://www.Philips.com/welcome).

Philips VitaShield IPS technology and NanoCloud technology ensures you “Healthy air always”.

VitaShield IPS technology effectively removes pollutants (ultrafine particles, allergens, bacteria and viruses) with size  $>0.02$  micron including bacteria and virus\*.

\*According to 2008 Microbiological Risk Assessment Report of the World Health Organization (WHO), the avian influenza, human influenza viruses, Legionella, Hepatitis viruses and SARS coronavirus are larger than 0.02 micron.

Read this user manual carefully before you install and use the unit. Save it for future reference.

### Overview (for AC4372)

①	Touchscreen control panel	⑥	Filter 3: Activated carbon filter
②	Light sensor	⑦	AC4153
③	Air quality light	⑧	Filter 2: Multi-care filter AC4151
④	Air quality sensor	⑨	Filter 1: Pre-filter
⑤	Filter 4: HEPA filter AC4154		Front panel

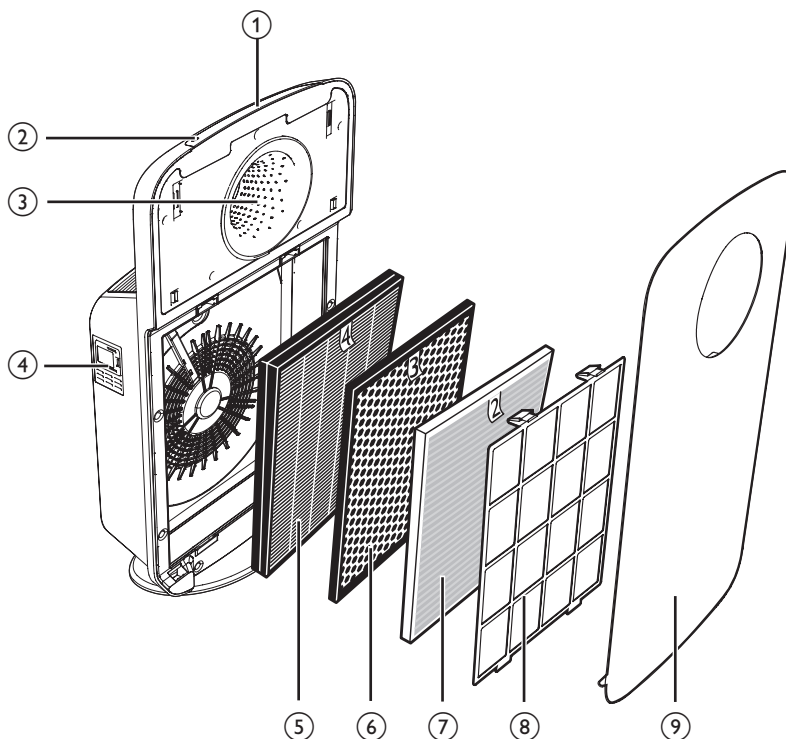

## Overview (for AC4374)

①	Touchscreen control panel	⑤	Filter 2: Integrated Multi-care filter
②	Light sensor	⑥	AC4138
③	Air quality light	⑦	Filter 1: Pre-filter Front panel
④	Air quality sensor		

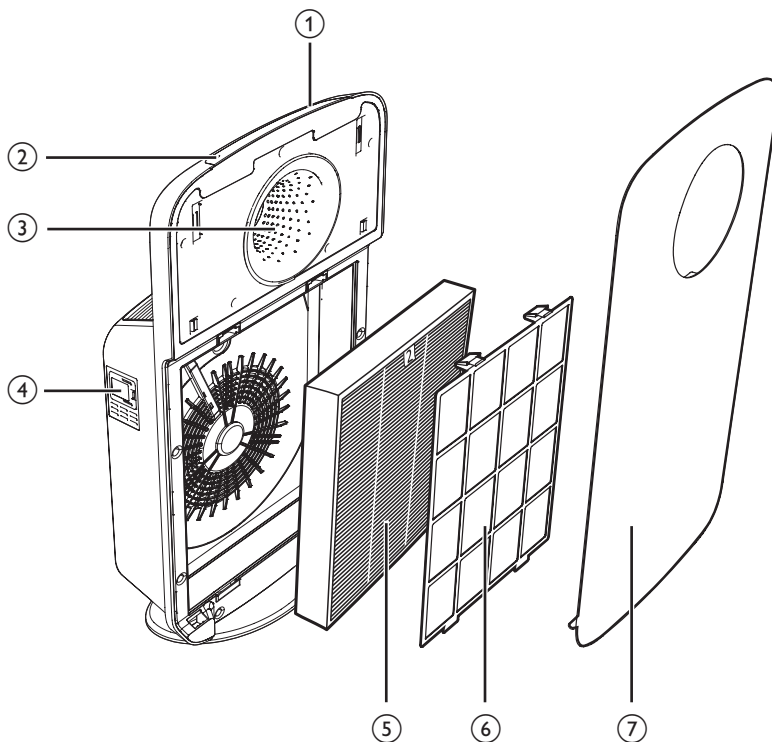



## 3 Get started

### Install filters

The appliance comes with all filters fitted inside, but you have to remove the packaging of the filters before you can use the appliance. Remove all filters, unpack them, and place them back into the appliance as described below.



#### Note

- Insert the filters in the correct position.

- 1 Place your fingers in the recesses of the side panels and gently pull the top part of the front panel towards you.

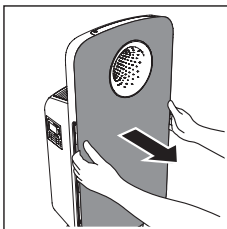

- 2 Lift the hooks at the bottom of the panel out of the bottom of the appliance.

- 3 To remove the pre-filter, grab the two projections and pull the filter towards you.

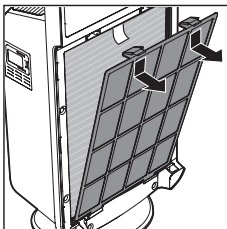

- 4 Remove all the filters from the appliance.

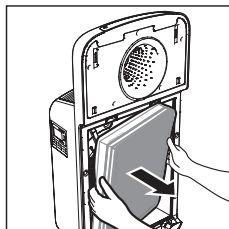

- 5 Remove all packaging material from the filters.

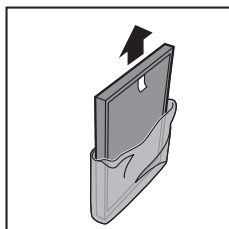

- 6 For AC4372, put the HEPA filter, activated carbon filter and multi-care filter back into the purifier.

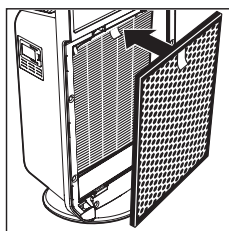
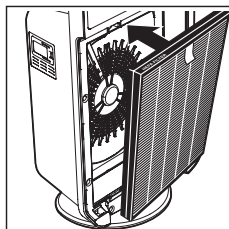

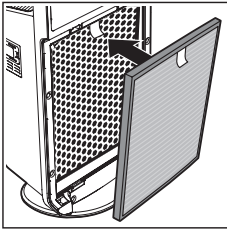

For AC4374, put the integrated Multi-care filter back into the purifier.

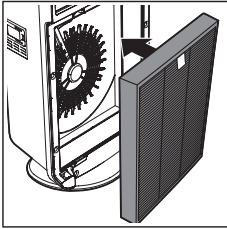

#### Note

- Make sure that the side with the tag is pointing towards you.

- 8 To reattach the front panel, insert the bottom hooks into the bottom of the appliance first (1). Then, push the panel against the body of the appliance (2).

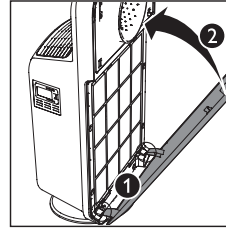

- 7 Place the pre-filer in the appliance.

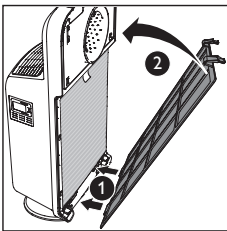

#### Note

- Make sure that the side with the two projections is pointing towards you, and that all hooks are properly attached to the appliance.

## 4 Use the air purifier

### Understand the air quality light

Color of the air quality light	Air quality level
Blue	Very good
Dark purple	Good
Purple	Fair
Red	Bad

The air quality light automatically goes on when the purifier is switched on.

#### Note

- The built-in air quality sensor measures the air quality and automatically selects the appropriate color of the air quality light. When the air is clean, the color of the air quality light is in blue. When the air quality deteriorates, the color of the air quality light changes from dark purple to red.

### Switch on

- Put the plug of the air purifier into the power socket.

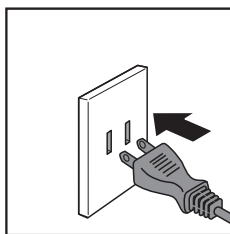

- ↳ All lights go on from left to right in cycle, and you hear a beep. Then, the lights go out again.
- ↳ The air quality light shows 4 colors successively.

- Press the  button to switch on the purifier.

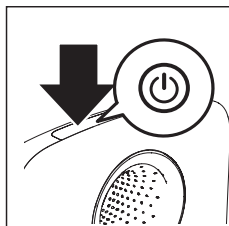

- ↳ The fan speed indicators 智能 and  goes on.

#### Note

- When the purifier is switched on, the air quality sensor will take some time to measure the air quality in the room. The air quality light changes its color and eventually stays in the correct color in accordance with the air quality.

- Press and hold the  button for 2 seconds to switch off the purifier.

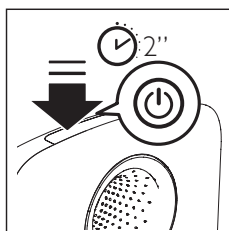

#### Tip

- The purifier has a memory mode. It will recall the previous settings of your last use.
- If you disconnect the purifier from the power supply after switching off, it will enter the default mode for next use. The fan speed is 智能.

## Set the sensitivity of the air quality sensor

To meet different needs when you use the appliance, we are offering you the opportunity to adjust the sensitivity of the air quality sensor.

There are 3 sensitivity levels:

- standard
- sensitive
- extra sensitive

The pollution sensor is set to extra sensitive. You can adjust the sensitivity of the air quality sensor in the following way.



### Note

- When it is set to a higher sensitivity, the purifier becomes more allergic to the pollutants in the air. When the purifier is in 智能 mode, it is more likely to choose a higher fan speed than the standard mode.

- 1 Unplug the air purifier from the power socket.

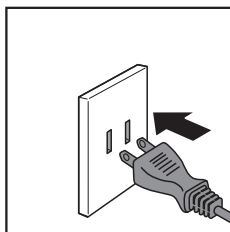

- 2 Wait for a while before putting the plug back into the power socket.

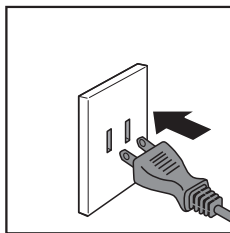

- 3 Press the and buttons simultaneously.

↳ The purifier beeps twice and one of the fan speed indicators (, or ) flashes to show the current sensitivity level of the air quality sensor.

Fan speed indicator	Sensitivity level
---------------------	-------------------

	Extra sensitive (default sensitivity)
--	---------------------------------------

	Sensitive
--	-----------

	Standard
--	----------

- 4 Press the button to adjust the sensitivity level of the air quality sensor.

↳ One of the indicators (, , or ) goes on to show the preferred sensitivity level of the air quality sensor.

- 5 Press and hold the button for 3 seconds to switch off the purifier, and the sensitivity setting is saved.



### Note

- When setting the sensitivity, if no button is pressed in 10 seconds, the purifier will skip the sensitivity setting mode, and maintain the previous setting.

## Select the fan speed

### Note

- After you change the sensitivity, the purifier automatically starts operating at the set sensitivity level whenever you switch on the purifier.

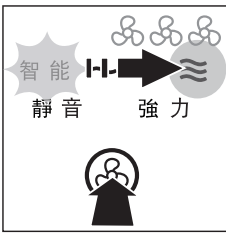

You can select the desired fan speed.

- Press the  button once or more times to select the desired fan speed (智能, ~, ≈, ≡, 静音, 或 強力).





## Set the timer

With the timer function, you can let the purifier operate for a set number of hours. When the set time has elapsed, the purifier automatically switches off.

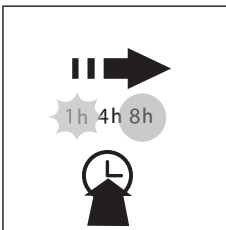
- Press the  button to activate the timer.
  - The timer indicator (1h, 4h, or 8h) goes on.
- Press the  button repeatedly to choose the number of hours you want the purifier to operate. The corresponding indicator (1h, 4h, or 8h) goes on.





To deactivate the timer function, press the  button repeatedly until the  indicator (1h, 4h, or 8h) is out.

## Activate child lock

You can activate the child lock function.

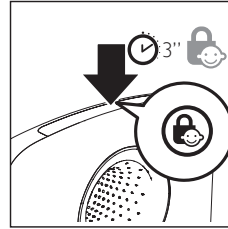
- Press and hold the  button for 3 seconds to activate the child lock.
  - The child lock indicator lights up.



- Press and hold the  button again for 3 seconds to deactivate the child lock.

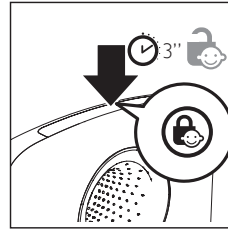

### Note

- When the child lock function is activated, all buttons are locked except the  button. There will be no audio feedback when you press the buttons.

---

## Night mode

The purifier works in harmony with its surroundings. The purifier automatically switches to night mode in 3 minutes when the room in which it is operating becomes dark. All the lights on the control panel slowly go out. You can touch any buttons on the control panel during this period, and the lights go back on. However, they will go out again in 5 seconds if the purifier is in idle. If the room becomes bright again for 5 minutes or longer, the purifier resumes normal operation.

## 5 Clean your air purifier

### Tip

- You could use the concave of the air quality light as a handle to lift the purifier up.

### Note

- Always unplug the purifier before you clean or move it.
- Never immerse the purifier in water or any other liquid.
- Never use abrasive, aggressive, or flammable cleaning agents such as bleach or alcohol to clean any part of the purifier.
- Only the pre-filter is washable. Other air purifier filters are not washable nor vacuum cleanable.

---

## Clean the air purifier

Regularly clean the inside and outside of the purifier body to prevent dust from collecting.

- 1 Wipe away dust with a soft dry cloth from the body of the purifier.

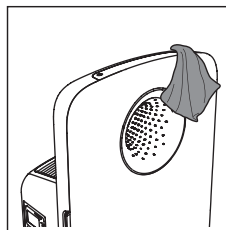

- 2 Clean the air inlet and the air outlet with a soft dry cloth.

## Clean the air quality sensor

Clean the air quality sensor every 2 months for optimal functioning of the purifier. Clean it more frequently if you use the purifier in a dusty environment.

### Note

- When the humidity level in the room is very high, it is possible that condensation develops on the air quality sensor. As a result, the air quality light may indicate that the air quality is bad even though it is good. In this case you have to clean the air quality sensor or use one of the manual speed settings.

- 1 Clean the air quality sensor inlet and the air quality sensor outlet with a soft brush.

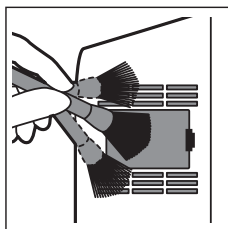

- 2 Remove the air quality sensor cover.

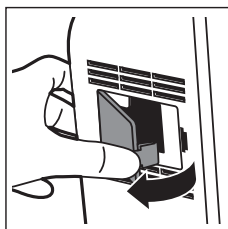

- 3 Clean the air quality sensor, the dust inlet and the dust outlet with a lightly moistened cotton swab.

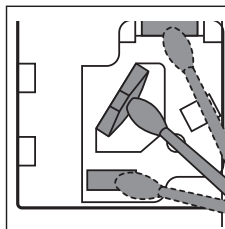

- 4 Dry them with a dry cotton swab.
- 5 Reattach the air quality sensor cover.

## 6 Clean the pre-filter

### Note

- The pre-filter is washable.
- Clean the pre-filter for every two weeks to ensure optimal functioning of the purifier.
- When the pre-filter needs cleaning, the

清潔濾網 1 goes on.

- 1 Switch off the purifier and unplug it.

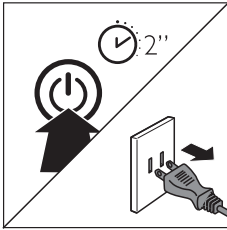

- 2 Place your fingers in the recess of the side panels and gently pull the top part of the front panel towards you. Then lift the hooks at the bottom of the panel out of the top of the purifier.

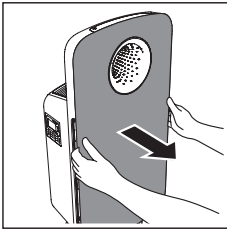

- 3 To remove the pre-filter, grab the two projections and pull the filter towards you.

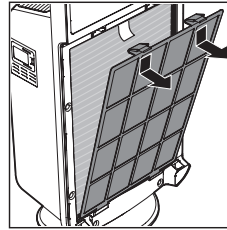

- 4 Use a vacuum cleaner or wash the pre-filter under a running tap. If the pre-filter is very dirty, use a soft brush to brush away the dust.

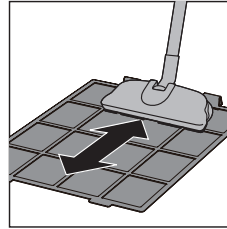

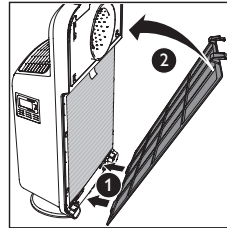

- 5 Air dry the pre-filter.
- 6 Put the pre-filter back into the purifier. Attach all hooks properly to the purifier.





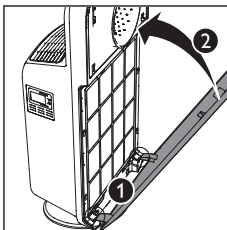

- 7 To reattach the front panel, insert the bottom hooks into the bottom of the purifier first (1). Then, push the panel against the body of the purifier (2).

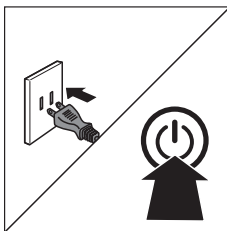

- 8 Plug the air purifier into the power socket and press the  button to switch on the purifier.



- 9 Press and hold the  button for 3 seconds to reset the filter lifetime.  
↳ 清潔濾網 1 go off.

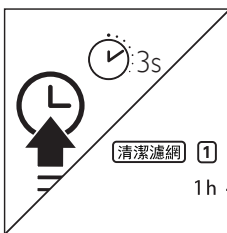

### Note

- Make sure that the pre-filter is completely dry. If it is still wet, bacteria may multiply in it and shorten the lifetime of the pre-filter.
- Make sure that the side with the two projections is pointing towards you, and that all hooks of the pre-filter are properly attached to the purifier.

## 7 Replace the filters

The indicator of the filter replacement 更換濾網 indicates the respective filters (2, 3, or 4) have to be replaced.

### Note

- Lifetime of the filter is based on the volume of air purified, it may differ from the way of using. In heavily polluted environment, the filter lifetime may be shorter than the recommended time.
- If you remove the front panel for filter changing while the purifier is switched on, all lights on the control panel will be off.
- Once the front panel is placed back to the purifier, it starts to run as its previous status.
- The replaceable filters are not washable nor vacuum cleanable.

### For AC4372

Replace the multi-care filter, the activated carbon filter, and the HEPA filter when the respective indicators (2, 3, and 4) go on.

### For AC4374

Replace the integrated Multi-care filter when the respective indicator (2) goes on.

This will last for approximately 2 weeks. On the last day of the 2 weeks, the purifier beeps every 30 minutes to inform you that the filter needs to be replaced.



### Note

- Insert the filters in the correct position.
- For AC4372, make sure you place the filters in the order of HEPA filter, the activated carbon filter, the multi-care filter, and then pre-filter.
- For AC4374, make sure you place the filters in the order of integrated Multi-care filter, and then pre-filter.
- Make sure that the side with the tag is pointing towards you.

**1** Switch off the purifier and unplug it.

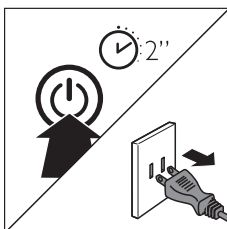

**2** Place your fingers in the recesses of the side panels and gently pull the front panel towards you. Then lift the panel off the hooks at the bottom of the purifier.



**3** To remove the pre-filter, grab the two projections and pull the filter towards you.

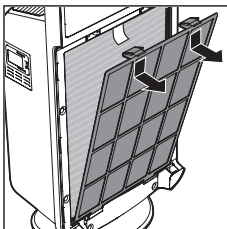

**4** For AC4372, remove the multi-care filter, activated carbon filter and HEPA filter from the purifier.

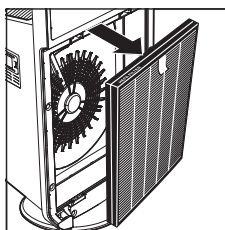
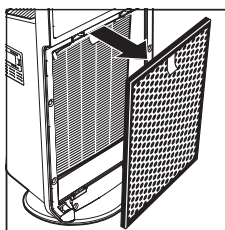
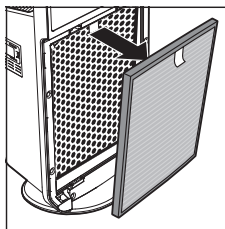

For AC4374, remove the integrated Multi-care filter from the purifier.

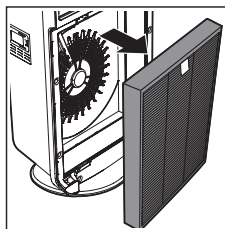

**5** Take the used filter by the two sides and deposit it gently into the household trash bin.



### Note

- Do not touch the pleated filter surface, or smell the filter as it has collected pollutants from the air.
- Wash your hands with tap water and soap after you have touched the used filter.

- 6** Remove all packaging material from the new filters that need replacement.
- 7** For AC4372, put the HEPA filter, activated carbon filter and multi-care filter back into the purifier.

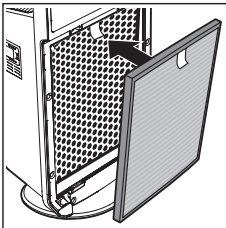
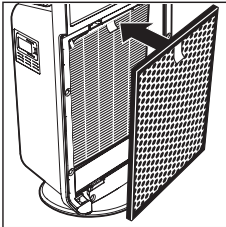
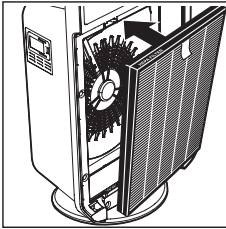

For AC4374, put the integrated Multi-care filter back into the purifier.

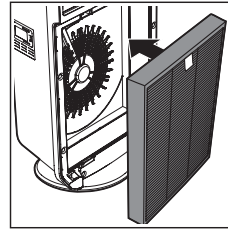

- 8** Put the pre-filter back into the purifier.

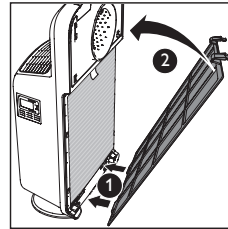

- 9** To reattach the front panel, insert the bottom hooks into the bottom of the purifier first (1). Then, push the panel against the body of the purifier (2).

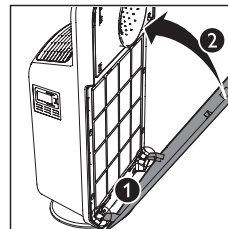

10 Press and hold the  button for 3 seconds to reset the filter lifetime.

↳ For AC4372: **2**, **3**, **4**, and **更換濾網** go off.

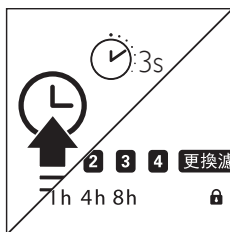



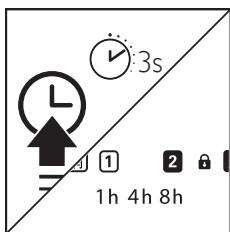



↳ For AC4374: **2** and **更換濾網** go off.



## Reset filter lock

After 2 weeks of filter replacement alert, and the filters are still not replaced. Then, the purifier will not work until the filter is replaced and the filter lock is reset.

The  goes on along with the filter replacement indicators (**2**, **3**, **4**, and **更換濾網**). All indicators are off except **兒童安全鎖** if it has been activated.

, , and  buttons remain active, while  and  buttons are deactive.

See “Replace the filters” section to reset the filter lock.

## 8 Troubleshooting

This chapter summarizes the most common problems you could encounter with the purifier. If you are unable to solve the problem with the information below, contact the Consumer Care Center in your country.

Problem	Possible solution
The 2, 3, 4 更換濾網 indicators has been on continuously.	The filter is full. Replace the filter and reset the purifier.
No air comes out of the air outlet.	The purifier is not connected to the power supply. Plug the purifier into the power supply and switch on.
The fan speed does not change when the 靜音 mode is activated.	In 靜音 mode, the fan speed is set to a very low level. If you want to change the fan speed, press the  button one or more times to set the desired fan speed.
The airflow that comes out of the air outlet is significantly weaker than before.	<ul style="list-style-type: none"> <li>• The pre-filter is dirty. Clean the pre-filter (see 'Clean the pre-filter').</li> <li>• You have not removed all packaging material from the filters. Make sure that you have removed all packaging material.</li> </ul>
The air quality does not improve, even though the purifier has been operating for a long time.	<ul style="list-style-type: none"> <li>• One of the filters has not been placed in the purifier. Make sure that all filters are properly installed in the following order, starting with the innermost filter: <b>For AC4372:</b> HEPA filter (4), activated carbon filter (3), multi-care filter (2) and pre-filter (1). <b>For AC4374:</b> Integrated Multi-care filter (2), pre-filter (1).</li> <li>• The air quality sensor is wet. The humidity level in your room is high and causes condensation. Make sure that the air quality sensor is clean and dry (see 'Clean the air quality sensor').</li> </ul>
The color of the air quality light always stays the same.	<ul style="list-style-type: none"> <li>• The air quality sensor is dirty. Clean the air quality sensor (see 'Clean the air quality sensor').</li> </ul>
I need cleaner air because I have an allergy.	You can change the air quality sensor sensitivity (see 'Set the sensitivity of the air quality sensor') to make the purifier clean the air even better.





---

The purifier is extra loud.

- Please check if you have removed all the packaging material from the filters.
- If the appliance is still too loud; you can change the fan speed to a lower fan speed level.

The purifier still indicates that I need to replace a filter, but I already did.

Perhaps you did not press the  button to reset the filter lock properly. Plug in the purifier, press the  button and press and hold the  button for 3 seconds.



## 9 Guarantee and service

If you need information or if you have a problem, please visit the Philips website at [www.philips.com](http://www.philips.com) or contact the Philips Consumer Care Center in your country (you will find its phone number in the worldwide guarantee leaflet). If there is no Consumer Care Centre in your country, go to your local Philips dealer.

---

### Order parts or accessories

If you have to replace a part or want to purchase an additional part, go to your Philips dealer or visit [www.philips.com/support](http://www.philips.com/support).

If you have problems obtaining the parts, please contact the Philips Consumer Care Center in your country (you will find its phone number in the worldwide guarantee leaflet).

## 10 Notices

---

### Electromagnetic fields (EMF)

This Philips appliance complies with all applicable standards and regulations regarding exposure to electromagnetic fields.

---

### Compliance with EMF

Koninklijke Philips N.V. manufactures and sells many products targeted at consumers, which, like any electronic apparatus, in general have the ability to emit and receive electromagnetic signals.

One of Philips' leading Business Principles is to take all necessary health and safety measures for our products, to comply with all applicable legal requirements and to stay well within the EMF standards applicable at the time of producing the products.

Philips is committed to develop, produce and market products that cause no adverse health effects. Philips confirms that if its products are handled properly for their intended use, they are safe to use according to scientific evidence available today.

Philips plays an active role in the development of international EMF and safety standards, enabling Philips to anticipate further developments in standardization for early integration in its products.

---

## Recycling

Do not throw away the product with the normal household waste at the end of its life, but hand it in at an official collection point for recycling.

By doing this, you help to preserve the environment.

Follow your country's rules for the separate collection of electrical and electronic products. Correct disposal helps prevent negative consequences for the environment and human health.



# 目錄

<b>1 重要事項</b>	26
安全	26
<b>2 您的空氣清淨機</b>	28
概覽 (針對 AC4372)	28
概覽 (針對 AC4374)	29
<b>3 開始使用</b>	30
安裝濾網	30
<b>4 使用空氣清淨機</b>	31
瞭解空氣品質指示燈	31
開機	31
設定空氣質量感測器的	
敏感度	32
選擇風速	33
設定定時器	33
啟動兒童鎖	34
夜間模式	34
<b>5 清潔空氣清淨機</b>	34
清潔空氣清淨機	34
清潔空氣質量感測器	34
<b>6 清潔預過濾網</b>	35
<b>7 更換濾網</b>	37
重設濾網鎖	39
<b>8 疑難排解</b>	40
<b>9 保固與服務</b>	41
訂購零件或配件	41

<b>10 聲明</b>	41
電磁場 (EMF)	41
回收	41

# 1 重要事項

## 安全

在使用本產品前，請先仔細閱讀本使用手冊，並保留說明以供日後參考。

## 危險

- 請勿讓水或其他液體，或是易燃清潔劑進入產品內，以避免電擊和 / 或火災。
- 請勿用水、其他液體，或是(易燃)清潔劑清潔產品，以避免電擊和 / 或火災。

## 警示

- 在連接本產品的電源之前，請確認本產品機體底部或後方所標示的電壓與本地的電源電壓是否相同。
- 如果電線損壞，您必須將其交由飛利浦、飛利浦授權之服務中心，或是具備相同資格的技師進行更換，以免發生危險。
- 當插頭、電源線或產品本身受損時，請勿使用本產品。
- 本產品可供 8 歲以上孩童、身體官能或心智能力退化者，或是經驗與使用知識缺乏者使用，但需要有人在旁監督或適當指示如何安全使用本產品，以及可能遭受的

危險。請勿讓兒童把玩本產品。若無人在旁監督，不得讓孩童清潔與維護產品。

- 請勿在出風口上方或進風口前面放置物品，擋住進出風口。

## 注意

- 本產品不可用來作為維持良好通風的設備、替代吸塵器清潔，或烹調時用來當作抽油煙機使用。
- 如果供應產品電力的電源插座接頭不良，產品插頭會發熱。請確定將產品插入接頭良好的插座。
- 請將本產品放置在乾燥平穩的水平面上使用。
- 產品的背面及側面須至少保留 20 公分的間隔距離，頂部則至少保留 30 公分的間隔距離。
- 產品頂部請勿堆放任何物品，請勿坐在產品上。
- 請勿將產品放置在冷氣機正下方，以免冷氣機滴水，造成產品發生水滴凝結的現象。
- 請在開啟產品電源前，先確認所有濾網皆已正確安裝。
- 請僅使用產品專用的飛利浦原廠濾網。請勿使用其他濾網。

- 切勿使用堅硬的物體敲打產品 (特別是進風口及出風口)
- 請勿將手指或任何物體放入出風口。
- 當您使用室內噴霧式驅蟲劑或在充滿油漬、燒香、香煙的火星或化學煙霧的地方時，請勿使用本產品。
- 請勿在氣體用品、加熱裝置或壁爐附近使用本產品。
- 使用完畢後或進行清潔之前，請務必先拔除電源插頭。
- 請勿在溫差變化極大的室內使用本產品，因為室溫差距太大會造成本產品內部凝結水珠。
- 請將本產品遠離使用無線電電波的電子電器至少 2 公尺以避免干擾，例如電視、無線電廣播、無線電信號控制的時鐘。
- 本產品為家用產品，僅限於在正常操作環境下使用。
- 請勿在極為潮濕或周遭溫度很高的環境下使用本產品，例如浴室、廁所或廚房。
- 本產品無法清除一氧化碳 (CO) 或氫氣 (Rn)。發生燃燒意外及危險化學物品意外時，本產品無法當作安全裝置使用。

## 2 您的空氣清淨機

感謝您購買本產品。歡迎來到飛利浦的世界！

請至 [www.Philips.com/welcome](http://www.Philips.com/welcome) 註冊您的產品，以獲得飛利浦提供的完整支援。

飛利浦 VitaShield IPS 技術和 NanoCloud 技術確保您「隨時享有健康好空氣」。

VitaShield IPS 技術可有效去除尺寸  $>0.02$  微米、包含細菌和病毒的汙染物 (超微粒、過敏原、細菌和病毒)\*。

\*根據世界衛生組織 (WHO) 2008 年的微生物風險評估報告，禽鳥類與人類的流感病毒、退伍軍人菌、肝炎病毒與 SARS 冠狀病毒皆大於  $0.02$  微米。

在您安裝和使用本裝置前，請先詳讀本使用手冊。敬請妥善保管本手冊，以供日後參考。

### 概覽 (針對 AC4372)

①	觸控螢幕控制面板	⑥	濾網 3：活性炭濾網 AC4153
②	光源感測器	⑦	濾網 2：多效淨化濾網 AC4151
③	空氣品質指示燈	⑧	濾網 1：預過濾網
④	空氣質量感測器	⑨	前面板
⑤	濾網 4：HEPA 濾網 AC4154		

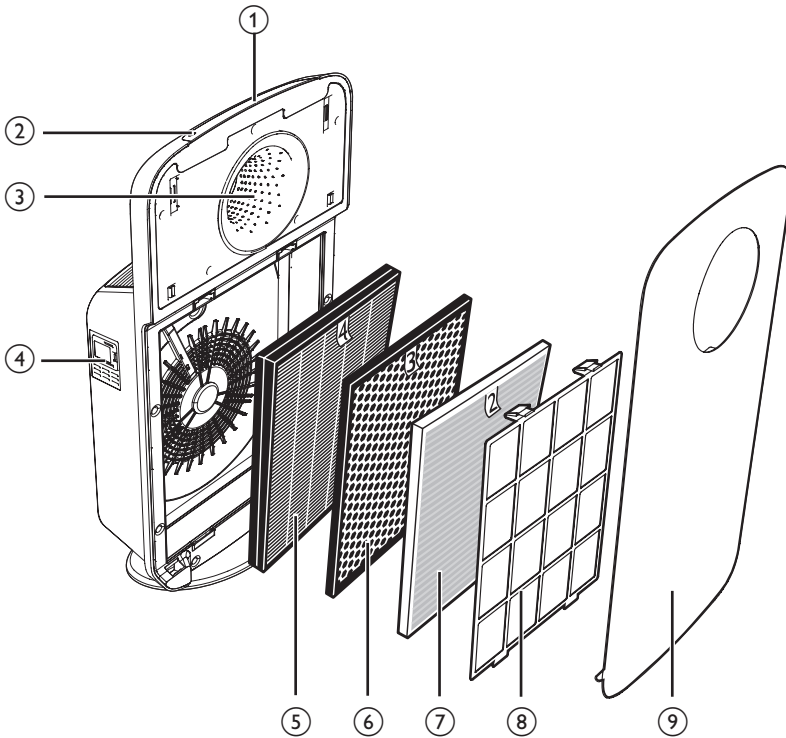

## 概覽 (針對 AC4374)

①	觸控螢幕控制面板	⑤	濾網 2：複合多效淨化濾網 AC4138
②	光源感測器	⑥	濾網 1：預過濾網
③	空氣品質指示燈	⑦	前面板
④	空氣質量感測器		

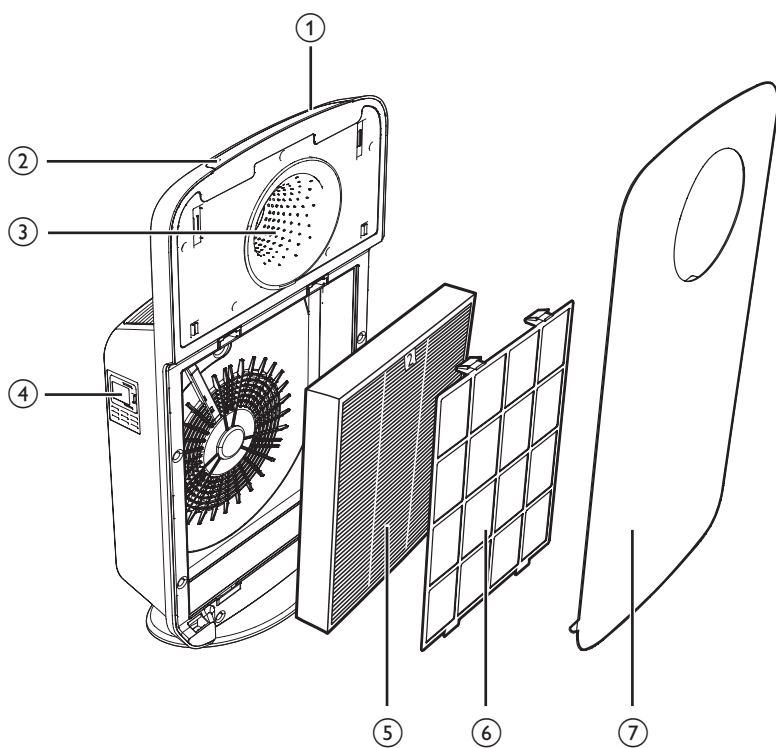

## 3 開始使用

### 安裝濾網

本產品所有隨附的濾網皆已妥善安裝在機體內，但是在使用前，必須先拆下濾網包裝。請先取出所有濾網，拆下濾網包裝，然後把濾網放回產品中，如下所述。

#### 備註

- 將濾網裝入正確的位置。

- 1 將手指放入兩邊護板的凹處，朝自己的方向輕輕拉出產品正面護板的頂部。

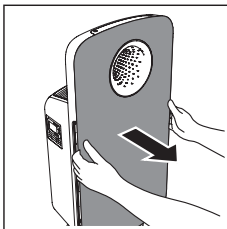

- 2 將護板底部的扣鉤自產品底部提起。
- 3 若要取出預過濾網，抓住濾網上兩個凸出部分，朝向自己拉出。

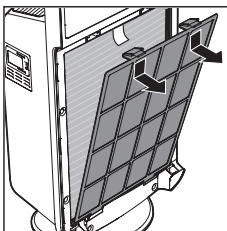

- 4 從產品內取出所有濾網。

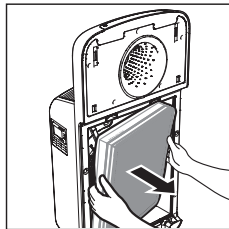

- 5 拆下濾網的所有包裝材料。

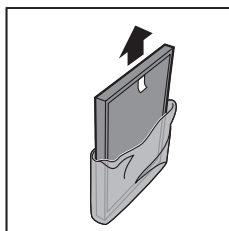

- 6 若為 AC4372，請將 HEPA 濾網、活性炭濾網和多效淨化濾網裝回清淨機。

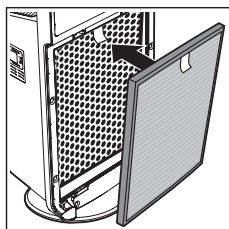
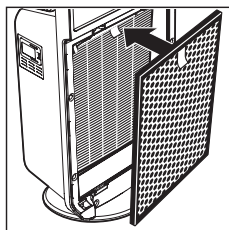
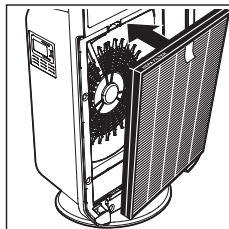

若為 AC4374，則將複合多效淨化濾網裝回清淨機。

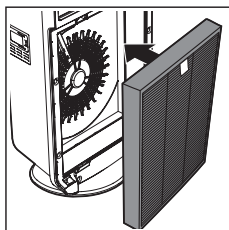

### 備註

- 請確認有拉片的那一側朝向自己。

## 7 將預過濾網裝入產品。

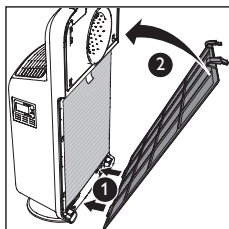

### 備註

- 請確認有兩個凸出部分的那一側朝向自己，且所有扣鉤皆已正確裝入產品。

## 8 若要重新裝入正面護板，先將底部扣鉤裝入產品底部 (1)。然後將護板推入產品機體 (2)。

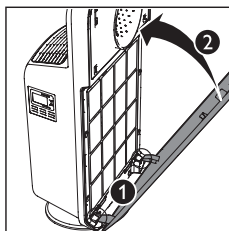

# 4 使用空氣清淨機

## 瞭解空氣品質指示燈

空氣品質指示燈的色彩	空氣品質等級
藍色	非常好
深紫色	很棒
紫色	普通
紅色	不良

清淨機電源開啟後，空氣品質指示燈就會自動亮起。

### 備註

- 內建空氣質量感測器會檢測空氣品質並自動選擇適當的空氣品質指示燈色彩。當空氣乾淨時，空氣品質指示燈會顯示藍色。當空氣品質降低，空氣品質指示燈會從深紫色變更為紅色。

## 開機

### 1 將空氣清淨機的插頭插入電源插座。

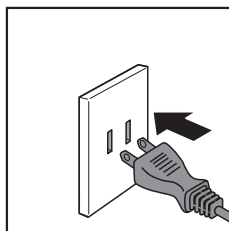

- 所有指示燈會從左至右循環閃爍，並發出嗶聲。然後指示燈再次熄滅。
- 空氣品質指示燈會依序顯示 4 個顏色。

2 按下  按鈕以開啟清淨機電源。

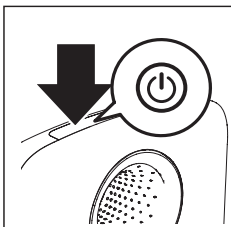

↳ 風速指示燈 智能 和  亮起。

### 備註

- 清淨機電源開啟後，空氣質量感測器會花一點時間測量室內的空氣品質。空氣品質指示燈會變更顏色，最後根據空氣品質停留在正確的顏色。

3 按住  按鈕 2 秒鐘以關閉清淨機電源。

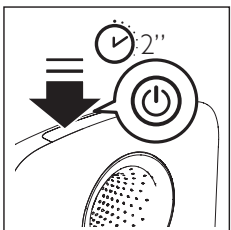

### 秘訣

- 清淨機具有記憶模式，會喚出您上次使用的先前設定。
- 若您在關閉清淨機電源後中斷其電源供應，它會在您下次使用時進入預設模式。風速為 智能。

## 設定空氣質量感測器的敏感度

為了符合您使用本產品的不同需求，我們提供讓您調整空氣質量感測器敏感度的機會。

敏感度的等級有 3 種：

- 標準
- 敏感
- 超敏感

污染感測器的設定為超敏感。空氣質量感測器的敏感度可依照下列方式調整。

### 備註

- 敏感度的等級設為較高時，清淨機對於空氣中的汙染物會變得較為敏感。當清淨機處於 智能 模式，較可能選擇高於標準模式的風速。



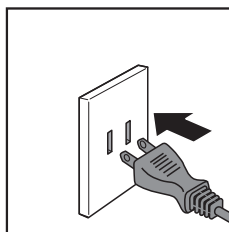

1 將空氣清淨機的插頭從電源插座拔除。

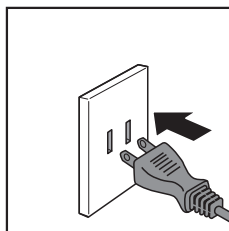









2 稍候片刻再將插頭插回電源插座。





- 3 同時按下  和  按鈕。  
 ↳ 清淨機會發出嗶聲兩次，其中一個風速指示燈（、 或 ）會閃爍，顯示空氣質量感測器目前的敏感度等級。

風速指示燈	敏感度等級
	超敏感 (預設敏感度)
	敏感
	標準

- 4 按下  按鈕，調整空氣質量感測器的敏感度等級。  
 ↳ 其中一個  指示燈（、 或 ）會亮起，顯示空氣質量感測器的偏好敏感度等級。
- 5 按住  按鈕 3 秒鐘以關閉清淨機電源，敏感度設定即會儲存。

#### 備註





- 設定敏感度時，如果沒有在 10 秒內按下任何按鈕，清淨機會略過敏感度設定模式，而維持先前設定。

## 選擇風速

#### 備註

- 在您變更敏感度之後，清淨機在開啟電源後，會依照您設定的敏感度等級，自動開始運作。

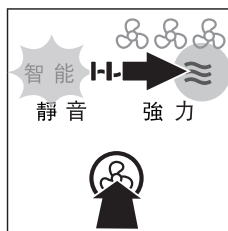

您可選擇想要的風速。

- 1 按下  按鈕一次或多次，選擇想要的風速（智能、、、、靜音或強力）。





## 設定定時器

您可以使用定時功能，讓清淨機在設定的小時數內運作。設定時間結束後，清淨機會自動關閉電源。

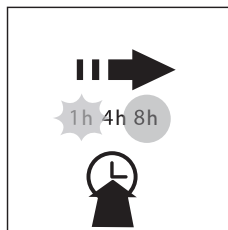
- 1 按下  按鈕啟動定時功能。  
 ↳ 定時指示燈（1h、4h 或 8h）會亮起。
- 2 重複按下  按鈕，選擇想要清淨機運作的小時數。對應的指示燈（1h、4h、或 8h）會亮起。



要關閉定時功能，請重複按下  按鈕，直到  指示燈（1h、4h 或 8h）熄滅。

## 啟動兒童鎖

您可以啟動兒童鎖功能。

- 1 按住  按鈕 3 秒鐘以啟動兒童鎖。  
↳ 兒童鎖指示燈會亮起。

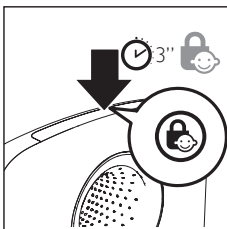

- 2 再次按住  按鈕 3 秒鐘以停用兒童鎖。

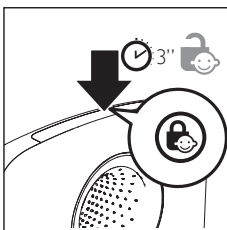

### 備註

- 當兒童鎖功能啟動時，除了  按鈕以外，所有按鈕皆會鎖住。當您按下按鈕時，不會有音訊回饋。

## 夜間模式

本清淨機能因應周遭環境協調運作。清淨機所處的室內光線變暗時，會在 3 分鐘後自動切換到夜間模式。控制面板上的所有指示燈會緩慢熄滅。在這段期間，您可碰觸控制面板上的任何按鈕，指示燈會再度亮起。然而如果清淨機處於閒置狀態，5 秒後會再度熄滅。

如果室內光線再度變亮長達 5 分鐘以上，清淨機會恢復正常運作。

## 5 清潔空氣清淨機

### 秘訣

- 您可使用空氣品質指示燈的凹面設計作為提起清淨機的握柄。

### 備註

- 進行清潔或移動前，請務必先拔掉清淨機的電源插頭。
- 切勿讓清淨機浸入水或其他液體中。
- 切勿使用漂白劑或酒精等具磨蝕性、刺激性或易燃洗劑清潔清淨機的任何部分。
- 只有預過濾網可水洗。其他空氣清淨機濾網皆「不得」水洗或用吸塵器清潔。

## 清潔空氣清淨機

定期清潔清淨機機體的內部與外殼，可避免累積灰塵。

- 1 請使用柔軟的乾布擦拭清淨機的機體。

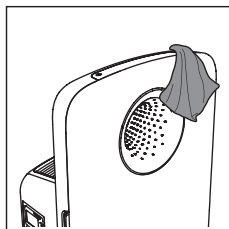

- 2 請使用柔軟的乾布清潔進風口及出風口。

## 清潔空氣質量感測器

每 2 個月清理空氣質量感測器，可確保清淨機發揮最佳效果。如果在佈滿灰塵的環境中使用清淨機，就要更常進行清潔。

## 備註

- 當室內濕度等級很高的時候，空氣質量感測器上可能會凝結水滴。如此一來，即使空氣品質良好，空氣品質指示燈可能會顯示空氣品質不良。在此情況下，您必須清潔空氣質量感測器，或使用手動風速設定。

- 1 請使用軟刷來清潔空氣質量感測器的進風口及出風口。

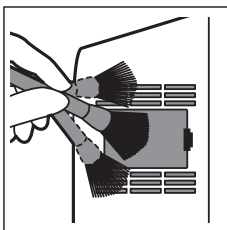

- 2 取下空氣質量感測器的護蓋。

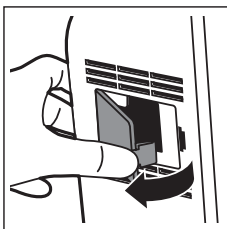

- 3 請使用略濕的棉棒，清潔空氣質量感測器、進風口和出風口。

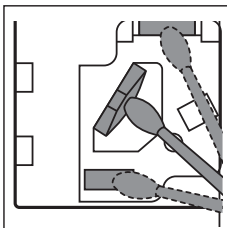

- 4 使用乾的棉棒擦乾。
- 5 裝上空氣質量感測器的護蓋。

## 6 清潔預過濾網

### 備註

- 預過濾網可水洗。
- 請每兩週清潔一次預過濾網，確保清淨機發揮最佳效果。
- 當預過濾網需要清潔時，**清潔濾網** ① 會亮起。

- 1 關閉清淨機電源，並拔除插頭。

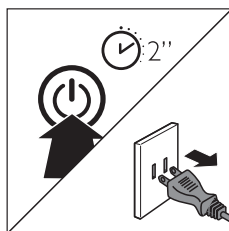

- 2 將手指放入兩邊護板的凹處，朝自己的方向輕輕拉出正面護板的頂部。然後將護板底部的扣鉤自清淨機頂部提起。

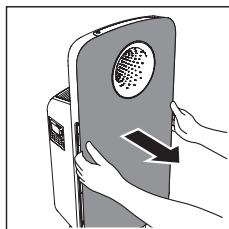

- 3 若要取出預過濾網，抓住濾網上兩個凸出部分，朝向自己拉出。

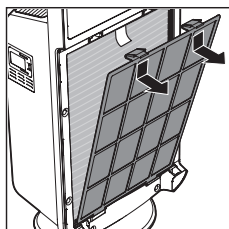

- 4 使用吸塵器清理預過濾網，或置於水龍頭下清洗。如果預過濾網很髒，請使用軟刷來清除灰塵。

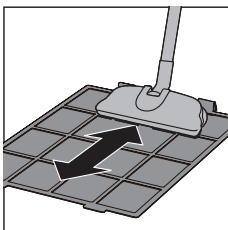

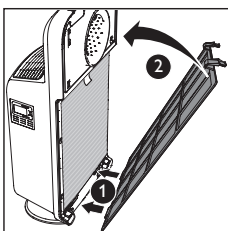

- 5 讓預過濾網自然風乾。

- 6 將預過濾網裝回清淨機中。將所有扣鉤正確扣入清淨機。

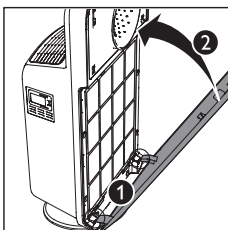

- 7 若要重新裝入正面護板，先將底部扣鉤裝入清淨機底部 (1)。然後將護板推入清淨機機體 (2)。



- 8 將空氣清淨機的插頭插入電源插座，按下  按鈕以開啟清淨機電源。

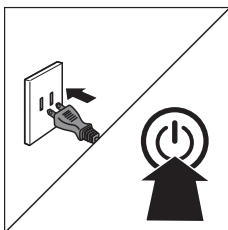

- 9 按住  按鈕 3 秒鐘可重設濾網使用壽命。

↳  清潔濾網  1 熄滅。

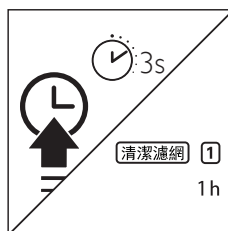

### 備註

- 請確認預過濾網完全乾燥。如果預過濾網未乾，細菌可能會在其中滋生，造成其使用壽命縮短。
- 請確認有兩個凸出部分的那一側朝向自己，且預過濾網的所有扣鉤皆已正確裝入清淨機。

## 7 更換濾網

濾網更換指示燈 **更換濾網** 指示必須更換個別濾網 (2、3 或 4)。

### 備註

- 濾網的使用壽命是根據濾淨的空氣量而定，可能因使用方式而有所不同。在嚴重汙染的環境中，濾網使用壽命可能短於建議時間。
- 如果您在清淨機電源開啟時為了更換濾網而取下正面護板，控制面板上的所有指示燈都會熄滅。
- 一旦將正面護板裝回清淨機，就會以先前態開始運轉。
- 更換式濾網皆不得水洗或用吸塵器清潔。

### 針對 AC4372

當個別指示燈 (2、3 和 4) 亮起時，請更換多效淨化濾網、活性炭濾網和 HEPA 濾網。

### 針對 AC4374

當個別指示燈 (2) 亮起時，請更換複合多效淨化濾網。

使用效期約為 2 週。

在 2 週的最後一天，清淨機每隔 30 分鐘會發出嗶聲，通知您濾網需要更換。

### 備註

- 將濾網裝入正確的位置。
- 若為 AC4372，請確認您先裝入 HEPA 濾網、活性炭濾網、多效淨化濾網，然後裝入預過濾網。
- 若為 AC4374，請確認您先裝入複合多效淨化濾網，再裝入預過濾網。
- 請確認有拉片的那一側朝向自己。

1 關閉清淨機電源，並拔除插頭。

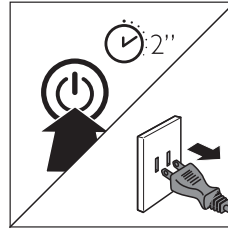

2 將手指放入兩邊護板的凹處，朝自己的方向輕輕拉出產品正面護板。然後將護板底部的扣鉤自清淨機底部提起。

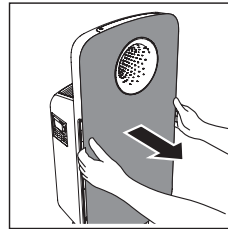

3 若要取出預過濾網，抓住濾網上兩個凸出部分，朝自己拉出。

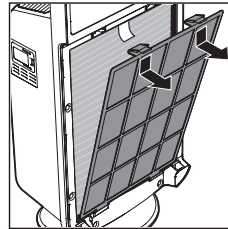

- 4 若為 AC4372，請從清淨機取出多效淨化濾網、活性炭濾網和 HEPA 濾網。

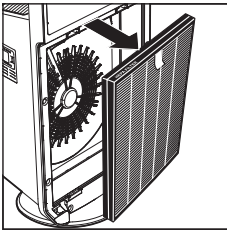
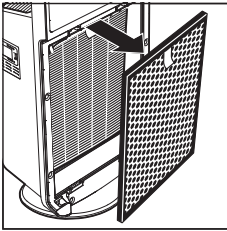
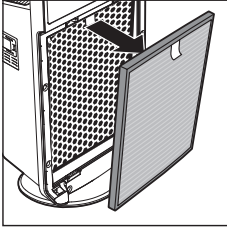

若為 AC4374，請從清淨機取出複合多效淨化濾網。

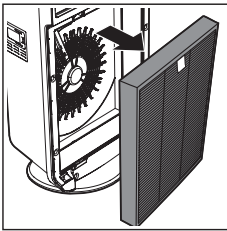

- 5 從兩側握住用過的濾網，輕輕丟棄至家用垃圾桶。

### 備註

- 請勿碰觸有皺摺的濾網表面或嗅聞濾網，因為它收集了空氣中的污染物。
- 當您碰觸到用過的濾網後，務必用自來水和肥皂洗手。

- 6 拆下更換用新濾網的所有包裝材料。
- 7 若為 AC4372，請將 HEPA 濾網、活性炭濾網和多效淨化濾網裝回清淨機。

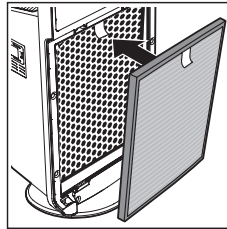
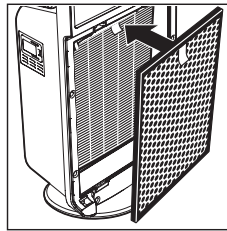
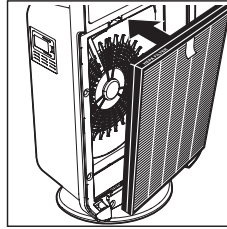

若為 AC4374，則將複合多效淨化濾網裝回清淨機。

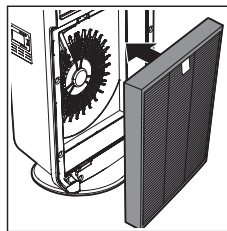

- 8 將預過濾網裝回清淨機中。

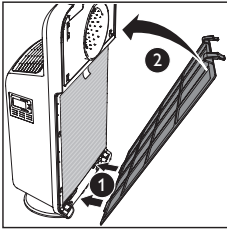

- 9 若要重新裝入正面護板，先將底部扣鉤裝入清淨機底部 (1)。然後將護板推入清淨機機體 (2)。

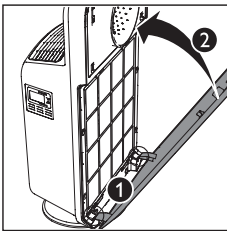

- 10 按住 按鈕 3 秒鐘可重設濾網使用壽命。

↳ 若為 AC4372：2、3、4 和 **更換濾網** 會熄滅。

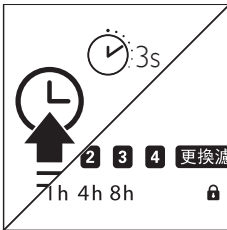

↳ 若為 AC4374：2 和 **更換濾網** 會熄滅。

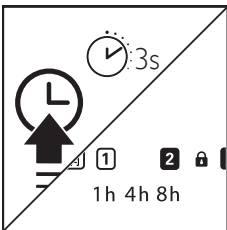





## 重設濾網鎖

在濾網更換警示燈亮起 2 週之後，仍未更換濾網。接著清淨機將無法運作，直到更換濾網並重設濾網鎖為止。

會與濾網更換指示燈 (2、3、4 和 **更換濾網**) 一同亮起。除了 **兒童安全鎖** (若已啟動) 以外，所有指示燈都會熄滅。、 和 按鈕會維持運作，而 和 按鈕則會停用。請參閱「更換濾網」一節以重設濾網鎖。

## 8 疑難排解

本單元概述您使用清淨機時最常遇到的問題。如果您無法利用以下資訊解決您遇到的問題，請聯絡您所在國家/地區的客戶服務中心。

問題	可能的解決方法
<b>2</b> 、 <b>3</b> 、 <b>4</b> 、 <b>更換濾網</b> 指示燈持續亮起。	濾網已滿。更換濾網與重設清淨機。
出風口沒有空氣流出。	清淨機沒有連接至電源供應器。請將清淨機插頭插入電源供應器，然後開啟電源。
靜音模式啟動時，風速沒有改變。	在靜音模式下，風速會設得很低。如果想要變更風速，請按下  按鈕一次或多次，設定所需的風速。
出風口流出的風速比之前慢很多。	<ul style="list-style-type: none"><li>· 預過濾網髒污。清潔預過濾網 (請參閱「清潔預過濾網」)。</li><li>· 您尚未拆下濾網的所有包裝材料。請確認已拆下所有包裝材料。</li></ul>
即使清淨機已經長時間運作，空氣品質仍未獲得改善。	<ul style="list-style-type: none"><li>· 其中一個濾網尚未裝入清淨機內。請確認所有濾網都已按照下列順序正確安裝，濾網從內至外分別為：若為 AC4372：HEPA 濾網 (4)、活性碳濾網 (3)、多效淨化濾網 (2) 和預過濾網 (1)。</li><li>· 若為 AC4374：複合多效淨化濾網 (2)、預過濾網 (1)。</li><li>· 空氣質量感測器潮濕。室內的濕度等級很高，造成水珠凝結。請確認空氣質量感測器乾淨且乾燥 (請參閱「清潔空氣質量感測器」)。</li></ul>
空氣品質指示燈的顏色一直維持不變。	<ul style="list-style-type: none"><li>· 空氣質量感測器髒污。清潔空氣質量感測器 (請參閱「清潔空氣質量感測器」)。</li></ul>
我會過敏，需要更乾淨的空氣。	您可以變更空氣質量感測器敏感度 (請參閱「設定空氣質量感測器的敏感度」)，讓清淨機把空氣清潔得更加徹底。
清淨機噪音很大。	<ul style="list-style-type: none"><li>· 請檢查是否已拆下濾網的所有包裝材料。</li><li>· 如果產品噪音仍然很大，可將風速變更為較低的速度等級。</li></ul>
清淨機不斷要求更換濾網，但濾網已經更換了。	您可能未確實按下  按鈕以重設濾網鎖。請為清淨機插上電源，按下  按鈕並按住  按鈕 3 秒鐘。



## 9 保固與服務

若您需要相關資訊，或是有任何問題，請造訪飛利浦網站：[www.philips.com](http://www.philips.com)，或聯絡您所在國家/地區的飛利浦客戶服務中心（您可在全球保證書上找到電話號碼）。若當地沒有客戶服務中心，請洽詢當地的飛利浦經銷商。

### 訂購零件或配件

如果您必須更換零件或想購買其他零件，請聯絡您的飛利浦經銷商，或造訪 [www.philips.com/support](http://www.philips.com/support)。

如果您有取得零件方面的問題，請聯絡您所在國家/地區的飛利浦客戶服務中心（您可在全球保證書上找到電話號碼）。

## 10 聲明

### 電磁場 (EMF)

本飛利浦產品符合所有電磁場暴露的相關適用標準和法規。

#### 符合 EMF 標準

Koninklijke Philips N.V. 製造銷售多項消費性產品，這些產品就如同其他電器，通常能收發電磁訊號。

飛利浦的一大企業原則，就是針對自身的產品進行必要的健康與安全檢測，以符合所有適用的法律規定，以及在產品生產期間符合適用的 EMF 標準。

飛利浦致力於開發、生產及銷售不危害健康的產品。飛利浦保證，只要依照正確用途並妥善使用，根據現有的科學研究資料，使用本公司產品並無安全顧慮。

飛利浦積極參與國際 EMF 與安全標準的開發，因此得以掌握標準化的發展，及早將標準化與自身的產品整合。

### 回收

本產品使用壽命結束時，請勿與一般家庭廢棄物一併丟棄。請將該產品送至政府指定的回收點或進行回收。此舉能為環保盡一份心力。

請遵循您所在國家/地區對電氣與電子產品分類收集的規定。正確處理廢棄產品有助於避免對環境和人類健康帶來負面影響。

設備名稱：飛利浦空氣清淨機， 型號（型式）：AC4374/80  
 Equipment name Type designation (Type)

單元 Unit	限用物質及其化學符號 Restricted substances and its chemical symbols					
	鉛 Lead (Pb)	汞 Mercury (Hg)	鎘 Cadmium (Cd)	六價鉻 Hexavalent chromium (Cr <sup>6+</sup> )	多溴聯苯 Polybrominated biphenyls (PBB)	多溴二苯醚 Polybrominated diphenyl ethers (PBDE)
電源線組	○	○	○	○	○	○
塑膠外殼	○	○	○	○	○	○
電源板組件	-	○	○	○	○	○
電動機	-	○	○	○	○	○
主電路板組件	-	○	○	○	○	○

備考1：“超出0.1 wt %”及“超出0.01 wt %”係指限用物質之百分比含量超出百分比含量基準值。

Note 1: “Exceeding 0.1 wt %” and “exceeding 0.01 wt %” indicate that the percentage content of the restricted substance exceeds the reference percentage value of presence condition.

備考2：“○”係指該項限用物質之百分比含量未超出百分比含量基準值。

Note 2: “○” indicates that the percentage content of the restricted substance does not exceed the percentage of reference value of presence.

備考3：“-”係指該項限用物質為排除項目。

Note 3: The “-” indicates that the restricted substance corresponds to the exemption.





© 2017 Koninklijke Philips N.V.  
All rights reserved.

4241 210 17343

