

GranBaristo

USER MANUAL

Type HD8964

Read carefully before using the machine.



EN

02



Register your product and get support at
www.philips.com/welcome

IMPORTANT SAFEGUARDS

When using electrical appliances, basic safety precautions should always be followed, including the following:

1. Read all instructions.
2. Do not touch hot surfaces. Use handles or knobs.
3. To protect against fire, electric shock and injury to persons do not immerse cord, plugs, or appliance in water or other liquid.
4. Close supervision is necessary when the appliance is used by or near children.
5. Unplug from outlet when not in use and before cleaning. Allow to cool before putting on or taking off parts, and before cleaning the appliance.
6. Do not operate any appliance with a damaged cord or plug or after the appliance malfunctions, or has been damaged in any manner. Return appliance to the nearest authorized service facility for examination, repair or adjustment.
7. The use of accessory attachments not recommended by the appliance manufacturer may result in fire, electric shock or injury to persons.
8. Do not use outdoors.
9. Do not let cord hang over edge of table or counter, or touch hot surfaces.
10. Do not place on or near a hot gas or electric burner, or in a heated oven.
11. Always attach plug to appliance first, then plug cord into wall outlet. To disconnect, turn any control to "off", then remove plug from wall outlet.
12. Do not use appliance for other than intended use.
13. Save these instructions.

SAVE THESE INSTRUCTIONS

CAUTION

This appliance is for household use only. Any servicing, other than cleaning and user maintenance, should be performed by an authorized service center. Do not immerse machine in water. To reduce the risk of fire or electric shock, do not disassemble the machine. There are no parts inside the machine serviceable by the user. Repair should be done by authorized service personnel only.

1. Check voltage to be sure that the voltage indicated on the nameplate corresponds with your voltage.
2. Never use warm or hot water to fill the water tank. Use cold water only.
3. Keep your hands and the cord away from hot parts of the appliance during operation.
4. Never clean with scrubbing powders or harsh cleaners. Simply use a soft cloth dampened with water.
5. For optimal taste of your coffee, use purified or bottled water. Periodic descaling is still recommended every 2-3 months.
6. Do not use caramelized or flavored coffee beans.

INSTRUCTIONS FOR THE POWER SUPPLY CORD

- A. A short power-supply cord (or detachable power-supply cord) is to be provided to reduce risks resulting from becoming entangled in or tripping over a longer cord.
- B. Longer detachable power-supply cords or extension cords are available and may be used if care is exercised in their use.
- C. If a long detachable power-supply cord or extension cord is used,
 1. The marked electrical rating of the detachable power-supply cord or extension cord should be at least as great as the electrical rating of the appliance
 2. If the appliance is of the grounded type, the extension cord should be a grounding-type 3-wire cord, and
 3. The longer cord should be arranged so that it will not drape over the counter top or table top where it can be pulled on by children or tripped over.

Congratulations on your purchase of a Saeco GranBaristo full automatic coffee machine!

To fully benefit from the support that Saeco offers, please register your product at www.philips.com/welcome.

This user manual applies to HD8964.

The machine is suitable for preparing espresso coffees using whole coffee beans, and it is supplied with a milk carafe so you can prepare your perfect Cappuccino or Latte Macchiato in a quick and easy way. In this user manual you will find all the information you need to install, use, clean and descale your machine.

CONTENTS

IMPORTANT	4
Safety Instructions	4
Warning	4
Caution	6
Compliance with Standards	7
INSTALLATION	8
Product Overview.....	8
General Description.....	9
PREPARING FOR USE	10
Machine Packaging	10
Machine Installation	10
USING THE MACHINE FOR THE FIRST TIME	12
Language Selection.....	12
Automatic Rinse/Cleaning Cycle	13
Manual Rinse Cycle.....	14
Measuring and Programming Water Hardness.....	17
"INTENZA+" Water Filter Installation	19
Replacing the "INTENZA+" Water Filter	22
ADJUSTMENTS	23
Coffee Profile.....	23
Enabling a New Profile	23
Disabling a User Profile	24
Saeco Adapting System.....	26
Adjusting the Ceramic Coffee Grinder	26
Adjusting the Aroma (Coffee Strength)	27
Adjusting the Dispensing Spout	28
Adjusting the Coffee Quantity	29
BREWING COFFEE	30
Coffee Brewing Using Coffee Beans	30
Coffee Brewing using Pre-Ground Coffee	31
MILK CARAFE	33
Filling the Milk Carafe	33
Inserting the Milk Carafe.....	34
Removing the Milk Carafe	34
Emptying the Milk Carafe.....	35

BREWING MILK-BASED BEVERAGES	36
Adjusting the Milk-Based Product Length	39
SPECIAL BEVERAGES	41
Hot Water	41
Adjusting the Hot Water Dispensing	43
Special Beverages Menu for Brewing Other Beverages	44
Adjusting the Other Beverages Quantity for the Menu "Special Beverages"	45
BEVERAGE PROGRAMMING	46
Aroma	47
Coffee Quantity	47
Temperature	47
Taste	48
Milk Quantity	48
HOT WATER PROGRAMMING	48
Water Quantity	48
Temperature	49
RESTORING BEVERAGE PARAMETERS	49
MACHINE PROGRAMMING	50
Water settings	50
Language Settings	51
Stand-by Settings	51
Factory Settings	52
STATISTICS	52
MAINTENANCE	53
Descaling	53
Brew Group Cleaning Cycle	53
Cleaning of the Carafe	54
CLEANING AND MAINTENANCE	55
Daily Cleaning of the Machine	55
Daily Cleaning of the Water Tank	57
Daily Cleaning of the Milk Carafe	57
Weekly Cleaning of the Machine	60
Weekly Cleaning of the Milk Carafe	60
Weekly Cleaning of the Brew Group	62
Monthly Cleaning of the Milk Carafe	65
Monthly Lubrication of the Brew Group	69
Monthly Cleaning of the Brew Group with "Coffee Oil Remover"	70
Weekly Cleaning of the Coffee Bean Hopper and Compartment	72
DESCALING	73
DISPLAY MESSAGES	77
TROUBLESHOOTING	79
ENERGY SAVING	82
Stand-by	82
Disposal	83
TECHNICAL SPECIFICATIONS	84
WARRANTY AND SERVICE	84
Warranty	84
Service	84
ORDERING MAINTENANCE PRODUCTS	85

IMPORTANT

Safety Instructions

This machine is equipped with safety features. Nevertheless read the safety instructions carefully and only use the machine as described in these instructions to avoid accidental injury or damage.

Keep this user manual for future reference.



The term **WARNING** and this icon warn against possible severe injuries, danger to life and/or damage to the machine.



The term **CAUTION** and this icon warn against slight injuries and/or damage to the machine.



This icon requests to read carefully this instruction manual, before performing any use or maintenance operation.

Warning

- Connect the machine to a wall socket with a voltage matching the technical specifications of the machine.
- Do not let the power cord hang over the edge of a table or counter, or touch hot surfaces.
- Never immerse the machine, mains plug or power cord in water (danger of electrical shock).
- Never direct the hot water jet towards body parts: danger of burns!
- Do not touch hot surfaces. Use handles and knobs.

- Remove the mains plug from the wall socket:
 - If a malfunction occurs.
 - If the machine will not be used for a long time.
 - Before cleaning the machine.

Pull on the plug, not on the power cord. Do not touch the mains plug with wet hands.

- Do not use the machine if the mains plug, the power cord or the machine itself is damaged.
- Do not make any modifications to the machine or its power cord. Only have repairs carried out by a service centre authorised by Philips to avoid a hazard.
- The machine should not be used by children younger than 8 years old.
- The machine can be used by children of 8 years and upwards if they have previously been instructed on the correct use of the machine and made aware of the associated dangers or if they are supervised by an adult.
- Cleaning and maintenance should not be carried out by children unless they are more than 8 years old and supervised by an adult.
- Keep the machine and its power cord out of reach of children under 8 years old.
- The machine may be used by persons with reduced physical, sensory or mental capabilities or lacking sufficient experience and/or skills if they have previously been instructed on the correct use of the machine and made aware of the associated dangers or if they are supervised by an adult.

- Children should be supervised to ensure that they do not play with the machine.
- Never insert fingers or other objects into the coffee grinder.

Caution

- The machine is for household use only and is not intended for use in environments such as canteens, staff kitchens of shops, offices, farms or other work environments.
- Always put the machine on a flat and stable surface.
- Do not place the machine on hot surfaces, directly next to a hot oven, heater or similar source of heat.
- Only put coffee beans into the coffee bean hopper. If ground coffee, instant coffee or any other substance is put in the coffee bean hopper, it may damage the machine.
- Let the machine cool down before inserting or removing any parts.
- Never use warm or hot water to fill the water tank. Use only cold non sparkling drinking water.
- Never clean with scrubbing powders or harsh cleaners. Simply use a soft cloth dampened with water.
- Descale your machine regularly. The machine indicates when descaling is needed. Not doing this will make your appliance stop working properly. In this case repair is not covered under your warranty!
- Do not keep the machine at temperature below 0 °C. Residue water in the heating system may freeze and cause damage.

- Do not leave water in the water tank when the machine is not used over a long period of time. The water can be contaminated. Use fresh water every time you use the machine.

Compliance with Standards

The machine complies with art.13 of the Italian Legislative Decree dated 25 July 2005, no. 151 "Implementation of the Directives 2005/95/EC, 2002/96/EC and 2003/108/EC on the restriction of the use of certain hazardous substances in electrical and electronic equipment, as well as waste disposal".

This machine complies with EU Directive 2002/96/EC.

This Philips appliance complies with all the applicable standards and regulations relating to the exposure to electromagnetic fields.

INSTALLATION

Product Overview

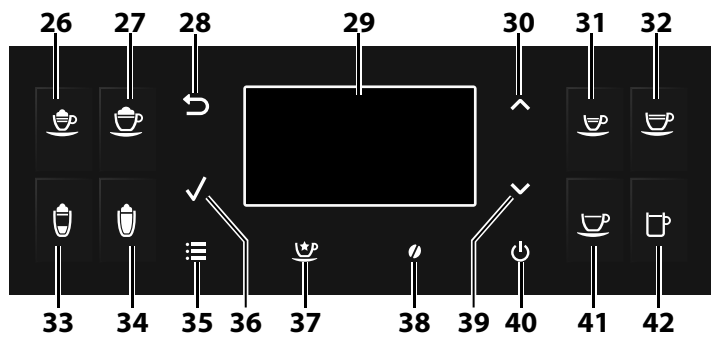
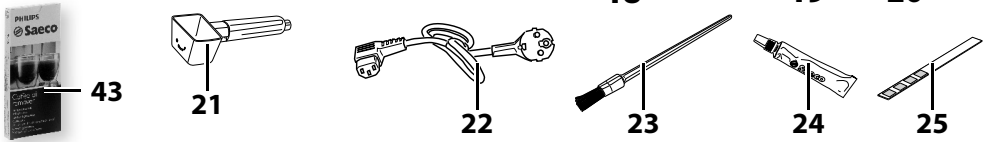
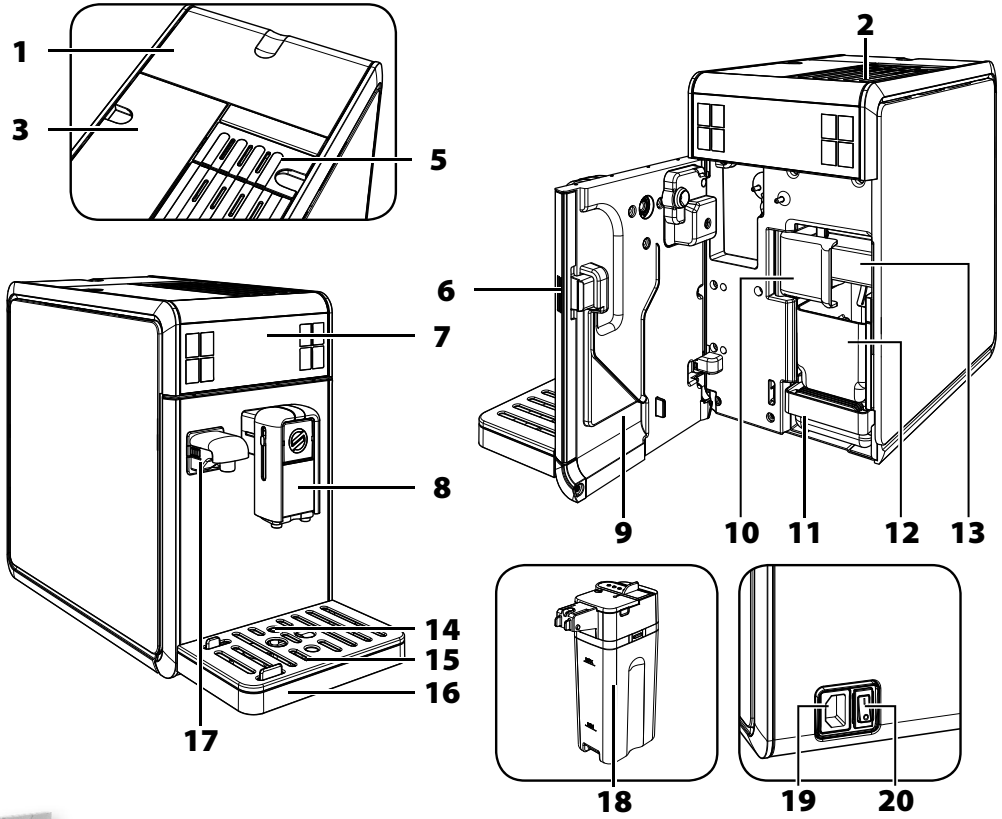

General Description

1. Coffee bean hopper with lid
2. Cup-warming surface
3. Water tank + lid
4. INTENZA+ water filter
5. Pre-ground coffee compartment
6. Service door button
7. Control panel
8. Removable dispensing spout
9. Service door
10. Brew group locking/removal handle
11. Drip tray (internal)
12. Coffee grounds drawer
13. Brew group
14. Full drip tray indicator
15. Cup holder grill
16. Drip tray (external)
17. Water dispensing spout (removable)
18. Milk carafe
19. Power cord socket
20. Power button
21. Pre-ground coffee measuring scoop / grinder adjustment key.
22. Power cord
23. Cleaning brush
24. Grease for the brew group
25. Water hardness test strip
26. Espresso Macchiato button
27. Cappuccino button
28. "ESC" button
29. LCD Display
30. "UP" button
31. Espresso button
32. Café Crème button
33. Latte Macchiato button
34. Hot Milk button
35. "MENU" button
36. "OK" button
37. "Special beverages" button
38. "Aroma" - Pre-ground coffee button
39. "DOWN" button
40. Stand-by button
41. Coffee button
42. American Coffee button
43. Coffee Oil Remover (to be purchased separately)
44. Descaling solution (to be purchased separately)

PREPARING FOR USE

Machine Packaging

The original packaging has been designed and constructed to protect the machine during transport. We recommend keeping the packaging material for possible future transport.

Machine Installation

1 Remove the drip tray with grill and the carafe from the packaging.

2 Remove the machine from the packaging.

3 For best use, it is recommended to:

- Choose a safe, level surface, where there will be no danger of overturning the machine or being injured.
- Choose a location that is sufficiently well-lit, clean and near an easily reachable socket.
- Allow for a minimum distance from the sides of the machine as shown in the illustration.

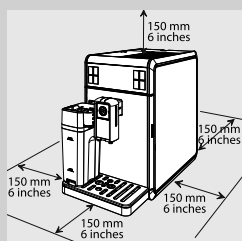

4 Insert the drip tray (external) with grill into the machine. Make sure it is correctly placed.

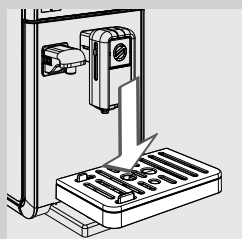

Note:

The drip tray collects the water that comes out of the dispensing spout during each rinse/self-cleaning cycle, as well as coffee that might be spilled during beverage brewing. Empty and wash the drip tray daily and each time the full drip tray indicator is raised.

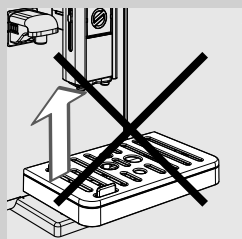

Caution:

NEVER remove the drip tray when the machine has just been turned on. Wait a couple of minutes for the machine to carry out a rinse/self-cleaning cycle.

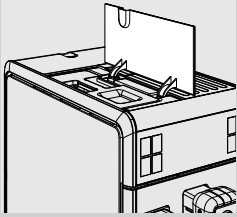

5 Lift the left outer lid.

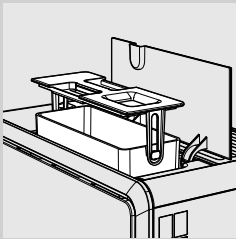

6 Remove the water tank by using the handle incorporated on the inner lid.

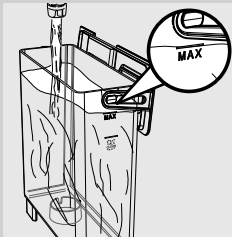

7 Rinse the water tank with fresh water.

8 Fill the tank with fresh drinking water up to the MAX level and place it back into the machine. Make sure it is fully inserted.

! **Caution:**
Never fill the water tank with warm, hot, sparkling water or any other liquid, as this may cause damage to the water tank and the machine.

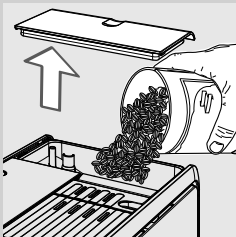

9 Remove the coffee bean hopper lid. Slowly pour in the coffee beans.

! **Caution:**
Only coffee beans must be put into the coffee bean hopper. Ground coffee, instant coffee, caramelized coffee or any other object may damage the machine.

10 Put the lid back on the coffee bean hopper.

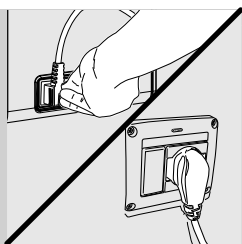

11 Insert the plug into the socket located on the back of the machine.

12 Insert the plug on the other end of the power cord into a wall socket with suitable power voltage.

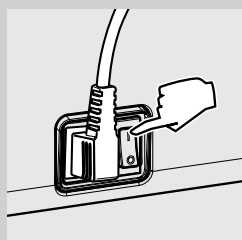

13 Switch the power button on the back of the machine to "I" to turn on the machine.

USING THE MACHINE FOR THE FIRST TIME

When using the machine for the first time, the following activities need to happen:

- 1) You have to select the language.
- 2) The machine will perform an automatic rinse/cleaning cycle.
- 3) You need to initiate a manual rinse cycle.

Language Selection

At first start up, the language must be selected.



1 The following display is shown. Select the desired language by pressing the scrolling buttons "▼" or "▲".



2 Press the "✓" button to confirm.



3 The machine is in warm-up phase.

Automatic Rinse/Cleaning Cycle

When warm-up is complete, the machine automatically performs a rinse/self-cleaning cycle of the internal circuit with fresh water. This takes less than a minute.



1 Place a container under the dispensing spout to catch the small amount of water which will be dispensed.

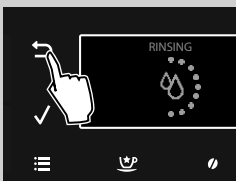

2 The following display is shown. Wait for the cycle to finish automatically.



Note:

To stop dispensing, press the “↶” button.

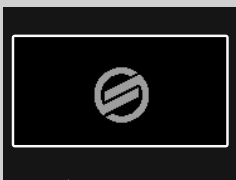

3 When the above steps are complete, the machine shows this display. You can now perform the manual rinse cycle.

Manual Rinse Cycle

You need to perform a rinse cycle when using the machine for the first time. During this process, the coffee brewing cycle is activated and fresh water flows through the dispensing spout. This takes a few minutes.

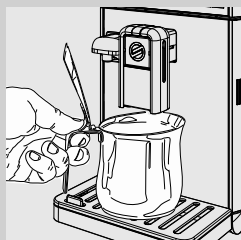

- 1 Place a container under the dispensing spout.

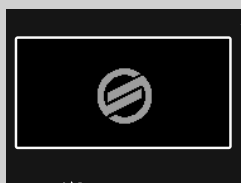

- 2 Check that the machine shows this display.



- 3 Press the "☉" button to enter the aroma selection menu.

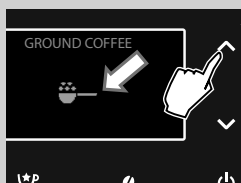

- 4 To select the pre-ground coffee brewing function, press the "▼" or "▲" scrolling button until the "☉" icon is displayed.



Note:

Do not add pre-ground coffee into the compartment.



- 5 Press the "☉" button.

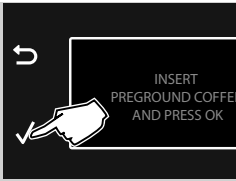

- 6** When choosing the product, the machine asks you to confirm that the ground coffee has been inserted. Press the “✓” button. The machine will start dispensing water from the dispensing spout.

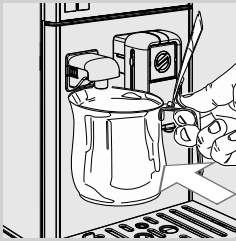

- 7** When the dispensing is complete, empty the container and place it back under the water dispensing spout.



- 8** Press the “★” button.

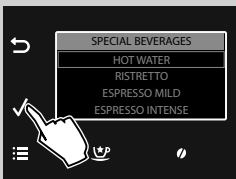

- 9** Press the “✓” button.



- 10** Press the “✓” button. At the end of the warm-up phase the machine starts dispensing water.

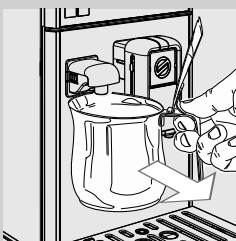

- 11** At the end of the operation, remove and empty the container.

- 12** Repeat the steps from 8 to 11 until the water tank is empty, then go on to step 13.

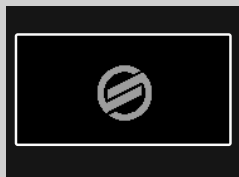
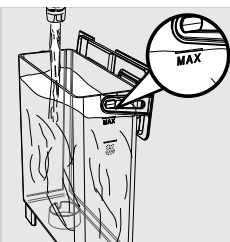

- 13** At the end, fill the water tank again up to the MAX level. Now the machine is ready for coffee brewing. This icon will be displayed.



Note:

When you haven't used the machine for 2 or more weeks, the machine will automatically perform an automatic rinse/self-cleaning cycle after you switch it on. Following this, you need to initiate a manual rinse cycle as described above.

The automatic rinse/self-cleaning cycle is also initiated when the machine has been in stand-by mode, or switched off, for more than 15 minutes. At the end of the cycle, it is possible to brew the products.

Measuring and Programming Water Hardness

Water hardness measuring is very important in order to define the machine descaling frequency and to install the "INTENZA+" water filter (for more details on the water filter, see next chapter).

To measure the water hardness follow the steps below:



- 1 Immerse the water hardness test strip (supplied with the machine) in water for 1 second.



Note:

The test strip can only be used for one single measurement.

- 2 Wait for one minute.

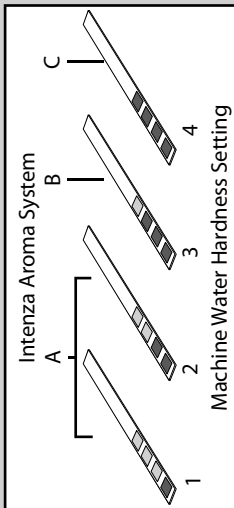

- 3 Check how many squares have changed to red, then consult this table.



Note:

The numbers on the water hardness test strip correspond to the water hardness adjustment settings.

More precisely:

- 1 = 1 (very soft water)
- 2 = 2 (soft water)
- 3 = 3 (hard water)
- 4 = 4 (very hard water)

The letters correspond to the references that are located at the base of the "INTENZA+" water filter (see next chapter).

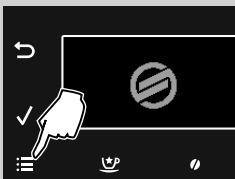

- 4 Press the "☰" button to access the machine main menu.



5 Press the “✓” button to select “**SETTINGS**”.

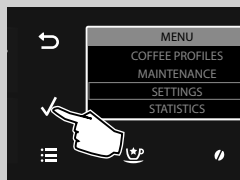

6 Press “✓” to confirm.

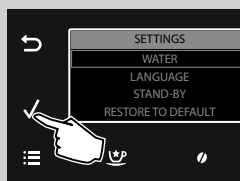

7 Press “✓” to confirm “**WATER**” selection.



8 Press “✓” to confirm “**HARDNESS**” selection.

 **Note:**

The machine is supplied with a standard water hardness setting, suitable for most types of water.



9 Press the “✓” button to increase the value or the “^” button to decrease the value.

10 Press the “✓” button to confirm the setting.

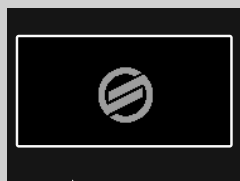

11 Press the “☰” button to exit the programming menu. Now the machine is ready to brew.

“INTENZA+” Water Filter Installation



We recommend you to install the “INTENZA+” water filter as this prevents limescale build-up in your machine and preserves a more intense aroma of your coffee.

Water is a crucial part of every coffee, so it is very important to always have it professionally filtered. Using the “INTENZA+” water filter will prevent mineral deposits from building up and improve your water quality.



- 1 Remove the “INTENZA+” water filter from its packaging, immerse it vertically (with the opening positioned upwards) in cold water and gently press the sides so as to let the air bubbles out.

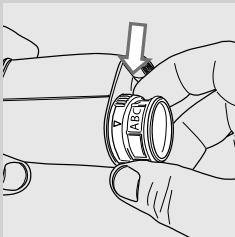

- 2 Set the “INTENZA+” water filter according to the measurements performed (see previous chapter) and indicated on the base of the filter:
 A = soft water – equals 1 or 2 on the test strip
 B = hard water (standard) – equals 3 on the test strip
 C = very hard water – equals 4 on the test strip

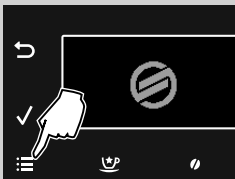

- 3 Press the “☰” button to access the machine main menu.

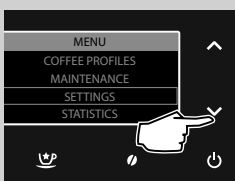

- 4 Press the “✓” button to select “SETTINGS”.

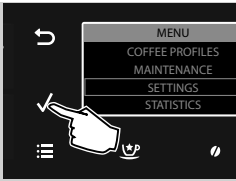

5 Press "✓" to confirm.

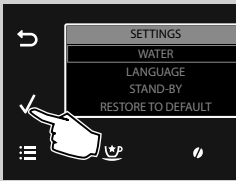

6 Press "✓" to confirm "WATER" selection.

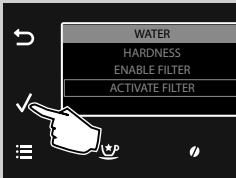

7 Press the "✓" button to select "ACTIVATE FILTER".

8 Press "✓" to confirm.

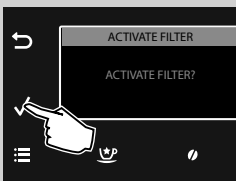

9 Press "✓" to confirm.



Note:

To exit activation, press the "↶" button.

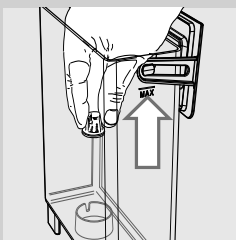

10 Remove the small white filter from the water tank and store it in a dry place.

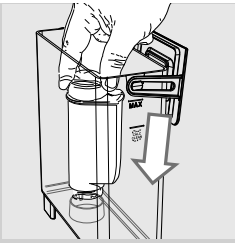

11 Put the "INTENZA+" water filter into the empty water tank. Press it down until it cannot move any further.

12 Fill the tank with fresh water up to the MAX level and place it back into the machine.

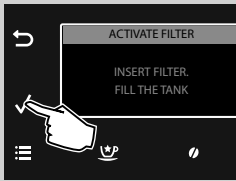

13 Press "✓" to confirm.

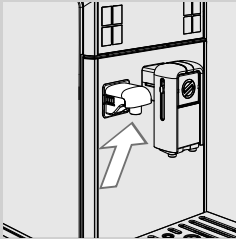

14 Check that the water dispensing spout is correctly installed.

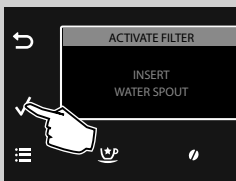

15 Press "✓" to confirm.

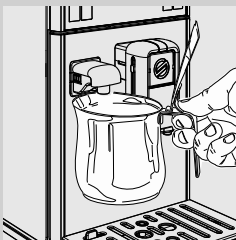

16 Place a container under the hot water dispensing spout.



17 Press "✓" to confirm.



18 The machine starts dispensing water. This screen will be displayed.



19 When the machine stops dispensing, remove and empty the container. Now the machine is ready to brew.

In this way the machine has been programmed to inform the user of the need to replace the "INTENZA+" water filter.

Replacing the "INTENZA+" Water Filter

When the "INTENZA+" water filter needs to be replaced with a new one, the following icon is displayed.

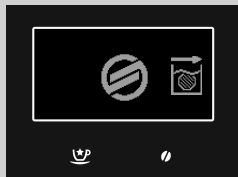

1 Replace the filter as described in the previous chapter.

2 The machine is now programmed to manage a new filter.



Note:

If the filter is already installed and you want to remove, but not replace it, select the "ENABLE FILTER" option and set it on OFF.

If there is no "INTENZA+" water filter installed, insert the small white filter previously removed into the water tank.

ADJUSTMENTS

The machine allows for certain adjustments so that you can brew the best tasting coffee possible.

Coffee Profile

The machine allows to accommodate the individual preferences and settings of up to 6 different profiles.

The machine has 1 preset profile indicated by the icon on the left.



You can create 5 additional profiles, which can be entirely customized. For a quick reference, users are represented by a unique icon, which has to be selected during programming.



Note:

You can select the profiles only after enabling them (see the “Enabling a New Profile” chapter).



After they have been enabled, the profiles can be selected by pressing the “✓” button or the “^” button. The profiles will be active right away, displaying the associated icon.

Enabling a New Profile



- 1 Press the “☰” button to access the machine main menu.

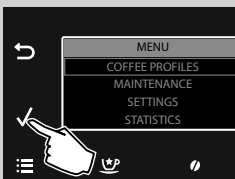

- 2 Press “✓” to confirm.



3 Press the “✓” to confirm the “ENABLE PROFILE” selection

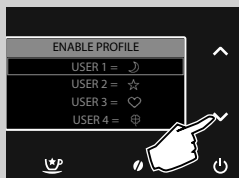

5 Press the “✓” button or the “^” button to select the desired profile, which will be represented by a unique icon.

Note:

When a profile has already been enabled, is not displayed in the possible options.

6 Press “✓” to confirm.

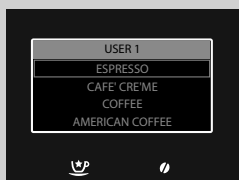

7 Now you can customise the beverages (see the “Beverage Programming” chapter).

Disabling a User Profile

You can disable an already enabled user profile, but not the preset profiles.

Note:

In this case, all the profile settings are kept in the memory but are not displayed. The respective icon is now available again in the enabling options. To enable the profile again, refer to the “Enabling a New Profile” section.

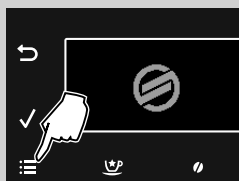

1 Press the “☰” button to access the machine main menu.

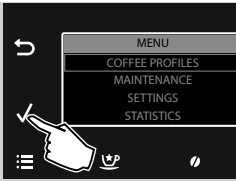

2 Press "✓" to confirm.

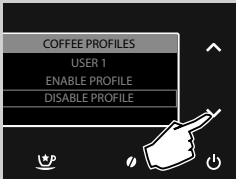

3 Press the "✓" button to select "DISABLE PROFILE".

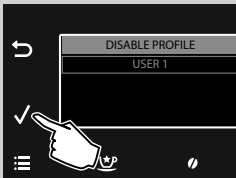

4 Press the "✓" button to select the profile to disable. Press the "✓" button to confirm. The profile is now disabled.



Note:

In this display all the profiles enabled earlier on will be shown. Only the selected profile will be disabled.

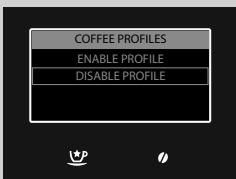

5 The following display is shown.

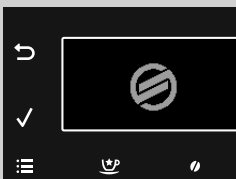

6 Press the "☰" button to exit the programming menu. Now the machine is ready to brew.

Saeco Adapting System

Coffee is a natural product and its characteristics may change according to its origin, blend and roast. The machine is equipped with a self-adjusting system that allows the use of all types of coffee beans available on the market except for caramelized and flavoured coffee beans.

The machine automatically adjusts itself after brewing several cups of coffee to optimize the extraction of the coffee.

Adjusting the Ceramic Coffee Grinder

Ceramic coffee grinders always guarantee accurate and perfect grinding and coarseness for every coffee speciality.

This technology provides for full aroma preservation, delivering the truly Italian taste in every cup.



Warning:

The ceramic coffee grinder contains moving parts that may be dangerous. Do not insert fingers or other objects. Only adjust the ceramic coffee grinder using the grinder adjustment key.

You can adjust the ceramic grinders to set the coffee grinding to your personal taste.

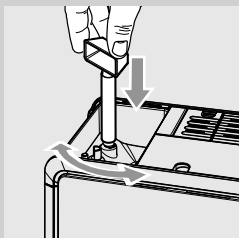

- 1** Press and turn the grinder adjustment knob inside the coffee bean hopper **one notch at a time**. Use the coffee grinder adjustment key provided with the machine. You will taste the difference after brewing 2-3 cups of coffee.



Warning:

Do not turn the coffee grinder more than one notch at the time to prevent damage.

Adjusting the Dispensing Spout

The height of the dispensing spout can be adjusted to better fit the dimensions of the cups that you wish to use.

Move the dispensing spout up or down with your fingers to adjust its height as shown in the image.

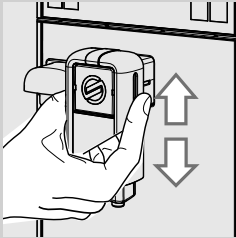

The recommended positions are:
For the use of small cups.



For the use of large cups.



For the use of glasses for the Latte Macchiato.



Note:

This is possible by moving the dispensing spout towards the machine.

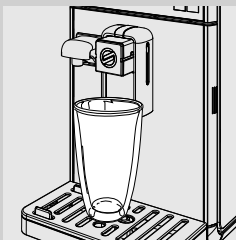

Two cups can be placed under the dispensing spout to brew two coffees at the same time.

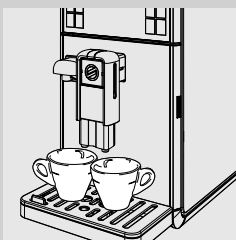

Adjusting the Coffee Quantity

The machine allows you to adjust the amount of brewed coffee or milk according to your taste and the size of your cups. Each time the Espresso “☕”, the Café Crème “☕”, the Coffee “☕” and the American Coffee “☕” buttons are pressed, the machine brews a preset amount of product. Each button may be individually programmed for a specific brew setting.

The following procedure describes the Espresso “☕” button programming.

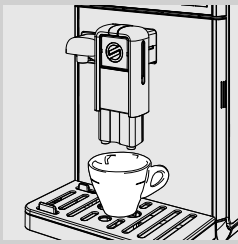

- 1 Place a cup under the dispensing spout.



- 2 Press and hold the Espresso “☕” button until the “MEMO” icon appears on the display, then release the button. The machine is now in programming mode. The machine starts brewing coffee.



- 3 Press the Espresso “☕” button as soon as the desired amount of coffee is reached.

Now the Espresso “☕” button is programmed; each time it is pressed, the machine will brew the same amount of espresso that was just programmed.



Note:

Follow the same steps to perform the programming of the Café Crème “☕”, Coffee “☕” and American Coffee “☕” buttons.

Once the desired amount is reached, press the selected brew button again to stop brewing.

You can also adjust the beverage length in the “**COFFEE PROFILES**” (see the “Beverage Programming” chapter, “**COFFEE AMOUNT**” option).

BREWING COFFEE



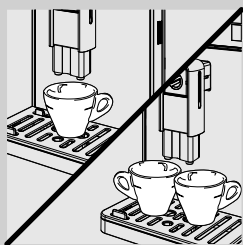

Before brewing the coffee, make sure that there are no warnings shown on the display, and that the water tank and coffee bean hopper are filled.

Coffee Brewing Using Coffee Beans

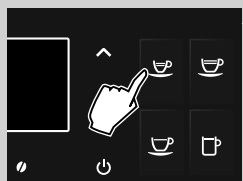

- 1 Place 1 or 2 cups under the dispensing spout.



- 2 Press the “” button for an Espresso, the “” button for a Café Crème, the “” button for a Coffee or the “” button for an American Coffee.

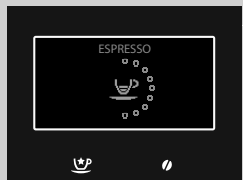

- 3 To brew 1 cup of coffee, press the desired button once. The following display is shown.



- 4 To brew 2 cups of coffee, press the desired button twice consecutively. The following display is shown.



Note:

In this operating mode, the machine automatically grinds and doses the proper amount of coffee.

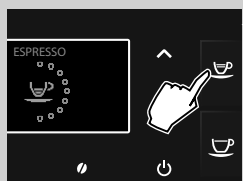

- 5 After the prebrewing cycle, coffee begins to pour out of the dispensing spout.
- 6 Coffee brewing automatically stops when the preset level is reached; press the same button that you pressed to start brewing to stop it earlier.

Coffee Brewing Using Pre-Ground Coffee

This function allows you to use pre-ground and decaffeinated coffee. With the pre-ground coffee function you can only brew one coffee at a time.

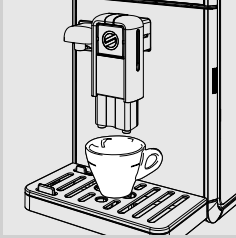

- 1 Place a cup under the dispensing spout.



- 2 Press the "☕" button to enter the aroma selection menu.

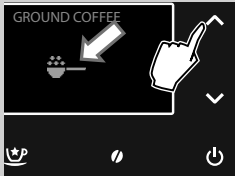

- 3 To select the pre-ground coffee brewing function, press the "✓" or "∧" scrolling button until the "☕" icon is displayed.

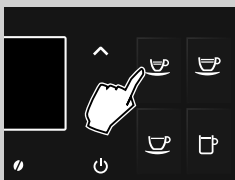

- 4 Press the "☕" button for an Espresso, the "☕" button for a Café Crème or the "☕" button for a Coffee.

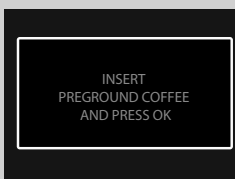

- 5 When choosing the product, the machine asks you to confirm that the ground coffee has been inserted.

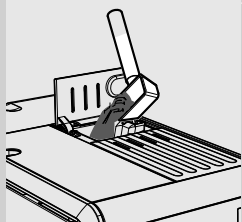

6 Open the pre-ground coffee compartment lid.

7 Add one measuring scoop of pre-ground coffee into the compartment. Use only the measuring scoop supplied with the machine. Then close the pre-ground coffee compartment lid.



Warning:

Add only pre-ground coffee to the pre-ground coffee compartment. Other substances and objects may cause severe damage to the machine. This repair is not covered by your warranty!

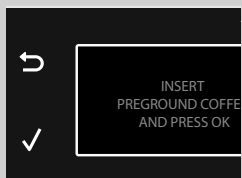

8 Press the "✓" button. After the prebrewing cycle, coffee begins to pour out of the dispensing spout.

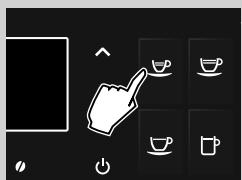

9 Coffee brewing automatically stops when the preset level is reached; press the same selected beverage button that you pressed previously to stop it earlier.

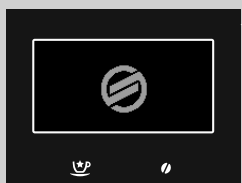

After brewing, the machine returns to the main menu.

Repeat the steps described above to brew more coffees using pre-ground coffee.



Note:

If no pre-ground coffee is poured into the compartment, only water will be dispensed.

If the dose is excessive or 2 or more measuring scoops have been added, the machine will discharge the excess ground coffee into the coffee grounds drawer.

It is not possible to memorize the brewing length with ground coffee.



Note:

This function remains active for 30 seconds. Then the machine resets the selection and goes back to the earlier status.

MILK CARAFE

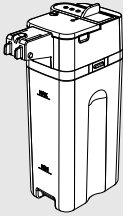

This chapter explains how to use the milk carafe to prepare milk-based beverages.



Note:

Before using the milk carafe, clean it thoroughly as described in the “Cleaning and Maintenance” chapter.

We recommend filling it with cold milk (approx. 5°C).



Warning:

Fill the carafe with milk for brewing beverages and with water for cleaning only.

Filling the Milk Carafe

The milk carafe can be filled before use or even during use.

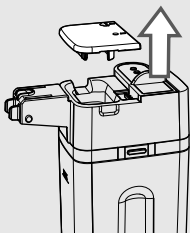

- 1 Lift the carafe lid as shown in the figure.

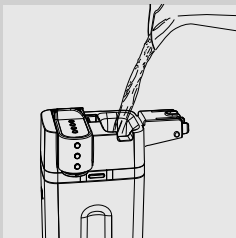

- 2 Pour the milk into the milk carafe: the milk level must be between the minimum (MIN) and maximum (MAX) level indicator shown on the milk carafe. Put the carafe lid back on.

- 3 The milk carafe is now ready to use.

Inserting the Milk Carafe

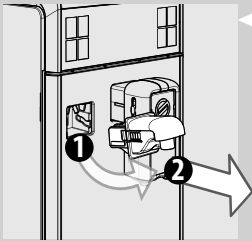

- 1** If installed, remove the water dispensing spout as shown in the figure:
- Press the two buttons on the side to unlock it and lift it slightly;
 - Pull the water dispensing spout to remove it.

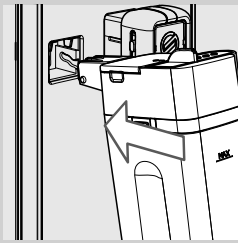

- 2** Slightly tilt the milk carafe. Insert it all the way into the guides of the machine.

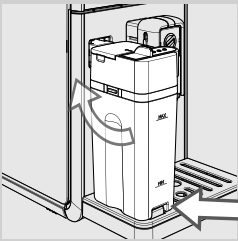

- 3** Push the carafe towards the bottom while rotating at the same time, until it is locked at the drip tray. Do not use force while inserting the carafe.

Removing the Milk Carafe

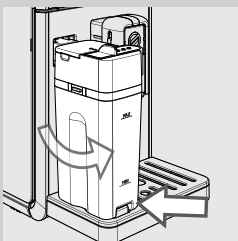

- 1** Rotate the carafe upwards until it releases from the insert in the drip tray. Then remove it.

Emptying the Milk Carafe

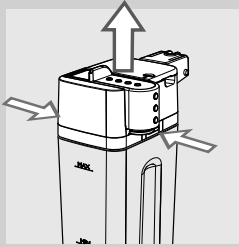

- 1 Press the release buttons to remove the top of the carafe.

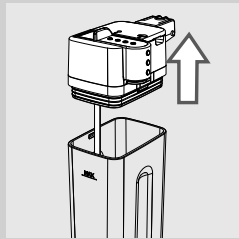

- 2 Lift the top of the carafe. Empty the milk carafe and clean it properly.

**Note:**

After each use, clean the milk carafe as described in the "Cleaning and Maintenance" chapter.

BREWING MILK-BASED BEVERAGES



Warning:

Danger of scalding! Dispensing may be preceded by short sprays of milk and steam. Wait until the end of the cycle before removing the milk carafe.

The buttons to prepare automatically an Espresso Macchiato “☕”, a Cappuccino “☕”, a Latte Macchiato “☕” and a Hot Milk “☕” are displayed on the control panel.

The procedure for brewing a Cappuccino “☕” is shown as an example.

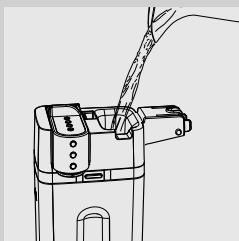

- 1 Fill the milk carafe with milk. The level must be between the minimum (MIN) and maximum (MAX) indication on the milk carafe. Put the carafe lid back on.



Note:

Use cold (~5 °C / 41°F) milk with a protein content of at least 3% to ensure optimum results when preparing a cappuccino. Whole milk or skimmed milk may be used depending on individual taste.

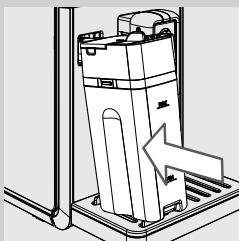

- 2 Insert the carafe into the machine.

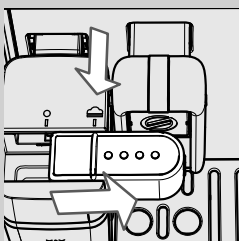

- 3 Pull out the milk carafe dispenser to the right up to the “☕” icon.



Note:

If the milk carafe dispenser has not been pulled all the way out, steam may escape and the milk may not be properly frothed.

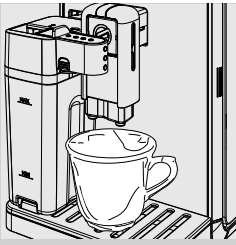

4 Place a cup under the dispensing spout.

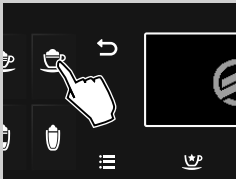

5 Press the Cappuccino “☕” button to start the brewing procedure.

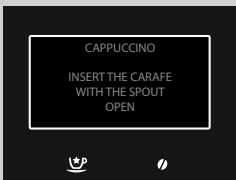

6 The machine reminds you to insert the carafe and pull out the dispensing spout.



7 The machine grinds the predefined quantity of coffee.

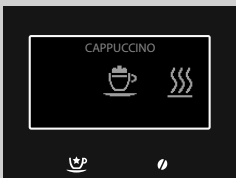

8 This icon is displayed during preheating time required by the machine.

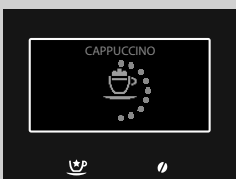

9 The machine starts dispensing milk. To stop the dispensing process, press the same selected beverage button that you pressed previously. The dispensing will stop in a few seconds.



- 10** Once the milk froth has been dispensed, the machine brews the coffee. To stop the brewing process, press the same selected beverage button that you pressed previously.

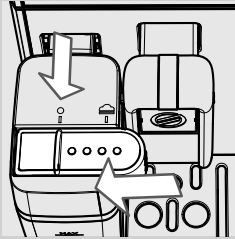

- 11** Insert the milk carafe dispenser back into position, scrolling it up to the "●" icon.

**Note:**

After using the milk carafe, clean it as described in the "Cleaning and Maintenance" chapter.

**Note:**

Follow the same steps to prepare an Espresso Macchiato "☕", a Latte Macchiato "☕" or a Hot Milk "☕". When you reach step 5, press the desired product button.

Adjusting the Milk-Based Product Length

Every time the Espresso Macchiato “☺”¹, the Cappuccino “☺”², the Latte Macchiato “☺”³ and the Hot Milk “☺”⁴ buttons are pressed, the machine brews a preset amount of selected beverage into the cup. The machine allows you to adjust the amount of each beverage according to your taste and the size of your cups.

The procedure for programming a Cappuccino “☺”² is shown as an example.

- 1 Fill the carafe with milk and insert it in the machine.
- 2 Pull out the milk carafe dispenser to the right up to the “☺”⁵ icon. Place a cup under the dispensing spout.

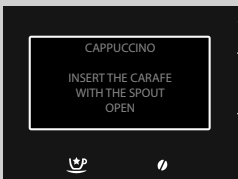
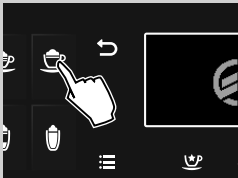
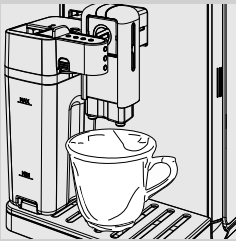

- 3 Press and hold the Cappuccino “☺”² button until this display is shown, then release the button. The machine reminds you to insert the carafe and pull out the dispensing spout. The machine is now in programming mode.



- 4 The machine grinds the predefined quantity of coffee.



5 This icon is displayed during preheating time required by the machine.



6 When the machine displays this icon, the machine starts to dispense milk froth into the cup. Once the desired amount of milk froth is reached, press the same selected beverage button that you pressed previously. The brewing will stop in a few seconds.



Note:

If you are dispensing a Hot Milk “”, the dispensing process ends with step six.





7 Once the milk froth has been dispensed, the machine starts brewing the coffee. When the desired quantity is reached, press the same selected beverage button that you pressed previously.

Now the Cappuccino “” button is programmed. Every time it is pressed, the machine will brew the same amount of cappuccino that was programmed.





Note:

Follow the same steps to prepare an Espresso Macchiato “”, a Latte Macchiato “” or a Hot Milk “”. When you get to step 3, press the desired product button.

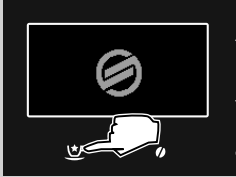

SPECIAL BEVERAGES

The machine is designed to brew more products than those described until now. For this follow the steps below.

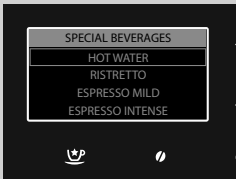

- 1 Press the “” button to enter the “**SPECIAL BEVERAGES**” menu.



- 2 Select the beverage by pressing the “” button or the “” button. Then press the “” button to start brewing.

- 3 To stop the beverage brewing, press the Special Beverages “” button again.



Note:

If you press the Special Beverages “” button without choosing any product, the machine returns to the main menu after 3 minutes.

With the special beverages function you can only brew one beverage at a time. To brew more beverages, repeat the procedure.

Hot Water



Warning:

Danger of scalding! Dispensing may be preceded by short sprays of hot water and steam. Wait until the end of the cycle before removing the water dispensing spout.

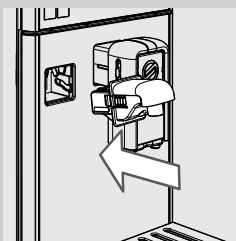

- 1 Remove the milk carafe, if inserted. Slightly tilt the water dispensing spout and insert it all the way into the guides of the machine.

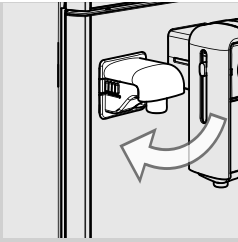

- 2 Push the water dispensing spout towards the bottom while rotating at the same time, until it is locked in the machine as shown in the figure.

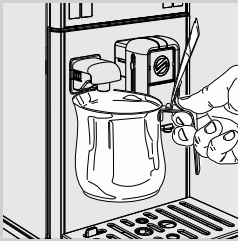



- 3 Place a container under the hot water dispensing spout.

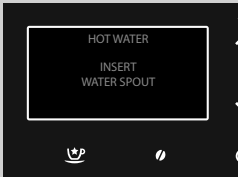

- 4 Press the “” button to enter the “**SPECIAL BEVERAGES**” menu.

- 5 Press the “” button to start the brewing.



- 6 This icon is displayed. The machine reminds you to install the water dispensing spout. Check that the water dispensing spout is correctly installed. Press “” to confirm. The machine will start dispensing hot water.

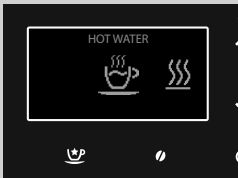

- 7 This icon is displayed during preheating time required by the machine.

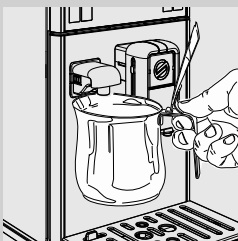

- 8 Dispense the desired amount of hot water. To stop the hot water dispensing, press the Special Beverages “” button again.

Adjusting the Hot Water Dispensing



Warning:

Danger of scalding! Dispensing may be preceded by short sprays of hot water and steam. Wait until the end of the cycle before removing the water dispensing spout.

1 Make sure that the machine is ready for the hot water dispensing.

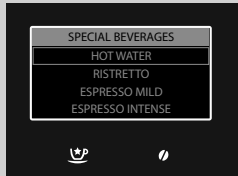

2 Press the “P” button to enter the “SPECIAL BEVERAGES” menu.

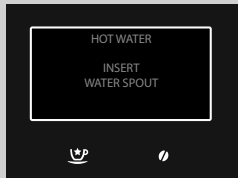

3 Press the “” button until this display is shown, then release the button.

4 Press “” to confirm. The machine will start dispensing hot water.

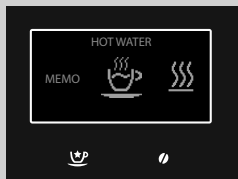

5 This icon is displayed during preheating time required by the machine.

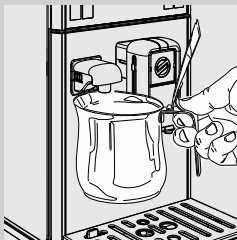

6 Dispense the desired amount of hot water.

To stop the hot water dispensing, press the Special Beverages “P” button again.

The amount of water to dispense is now programmed. Every time it is selected, the machine will dispense the same amount of hot water that was programmed.

Special Beverages Menu for Brewing Other Beverages

The menu allows you to brew other beverages, according to your personal taste.

The procedure for brewing a strong coffee is shown as an example.





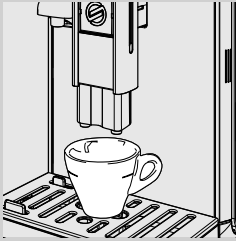

Note:

Follow the same steps to brew the other menu beverages. Only when you are brewing the "Flat white" you need to prepare the machine as for brewing a Cappuccino.

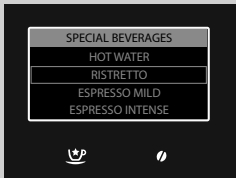

- 1 Place 1 cup under the dispensing spout.



- 2 Press the "P" button to enter the "SPECIAL BEVERAGES" menu.
- 3 Select the beverage by pressing the "" button until you reach the "RISTRETTO" option.
- 4 Press the "" button to start the brewing.
- 5 Coffee brewing automatically stops when the preset level is reached; press the "Special beverages" "P" button again to stop it earlier.

Adjusting the Other Beverages Quantity for the Menu "Special Beverages"

This procedure allows you to adjust the quantity of the other beverages displayed on the menu, according to personal taste.

The procedure for brewing a strong coffee is shown as an example.



Note:

Follow the same steps to brew the other menu beverages. Only when you are brewing the "Flat white" you need to prepare the machine as for brewing a Cappuccino.

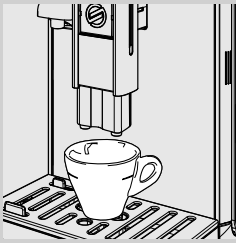

- 1 Place 1 cup under the dispensing spout.

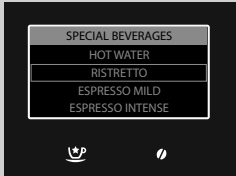

- 2 Press the "☕" button to enter the "SPECIAL BEVERAGES" menu.

- 3 Select the beverage by pressing the "✓" button until you reach the "RISTRETTO" option.

- 4 Press and hold the "✓" button until the "MEMO" icon appears on the display, then release the button. The machine is now in programming mode.

The machine starts brewing coffee.

- 5 Press the "☕" button as soon as the desired amount of coffee is reached.



Now the beverage is programmed; each time it is selected, the machine will brew the same amount that was just programmed.



Note:

Only when you are brewing the "Flat white" you need to program the amount of milk and coffee separately, as shown for brewing a Cappuccino.

BEVERAGE PROGRAMMING

The machine allows you to customise every beverage according to your personal taste and to memorize the preferences in your personal profile.

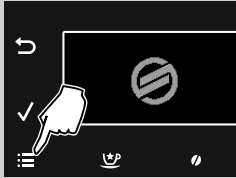

1 Press the "☰" button to access the machine main menu.



2 Press "✓" to confirm.



3 Press the "✓" button to select the enabled profile in which you wish to program the beverage.



4 Press "✓" to confirm.



Note:

The parameters to adjust for brewing a cappuccino are shown as an example. Follow the same steps to adjust other beverages. The milk parameters are not available for the coffee-only beverages.

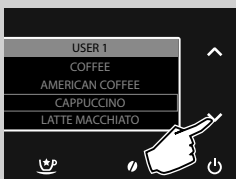

5 Press the "✓" button to select "CAPPUCCINO".

6 Press "✓" to confirm.

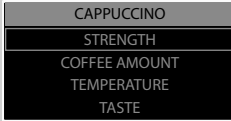

The parameters to adjust are displayed.
 To select them, press the "▼" or "▲" scrolling button.
 To enter, press the "✓" button.
 To return to the previous screen, press the "↶" button.
 To return to the initial screen, press the "☰" button.



Aroma

This setting adjusts the amount of coffee to ground.

- = very mild aroma
- = mild aroma
- = regular aroma
- = strong aroma
- = very strong aroma
- = extra strong aroma
- ☕ = ground coffee

Press the "▼" or "▲" scrolling button to select, then press the "✓" button to confirm.

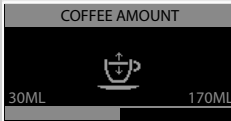

Coffee Quantity

By adjusting the bar on the display with the "▼" or "▲" scrolling button, you can choose the amount of water used for coffee brewing.
 Press "✓" to confirm the adjustment.

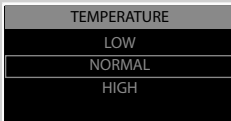

Temperature

This setting allows you to adjust the coffee temperature.

- LOW** : low temperature.
- NORMAL** : medium temperature.
- HIGH** : high temperature.

Press the "▼" or "▲" scrolling button to select, then press the "✓" button to confirm.



Taste

This setting enables the prebrewing function. During prebrewing, the coffee is slightly dampened to bring out the aroma in full.

DELICATE: prebrewing function is not performed.

BALANCED: prebrewing function is enabled.

FULL BODY: prebrewing function lasts longer to enhance the coffee taste.

Press the "▼" or "▲" scrolling button to select, then press the "✓" button to confirm.



Milk Quantity

By adjusting the bar on the display with the "▼" or "▲" scrolling button, you can choose the quantity of milk to use for the selected beverage. Press "✓" to confirm the adjustment.



Note:

The milk adjusting options are displayed only for the milk-based beverages.

HOT WATER PROGRAMMING

The following procedure describes the programming of hot water.



1 Press the "▼" button to select "**HOT WATER**".

2 Press "✓" to confirm.

Water Quantity

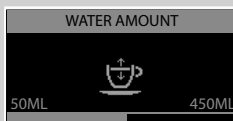

By adjusting the bar on the display with the "▼" or "▲" scrolling button, you can choose the quantity of water to be dispensed. Press "✓" to confirm the adjustment.

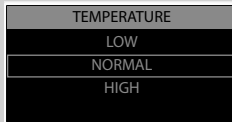

Temperature

This setting allows you to adjust the coffee temperature.

LOW : low temperature.

NORMAL : standard temperature.

HIGH : high temperature.

Press the "✓" or "∧" scrolling button to select, then press the "✓" button to confirm.

RESTORING BEVERAGE PARAMETERS

The factory setting of every beverage can be restored for each profile.

- 1 Press the "✓" button to select "**RESTORE TO DEFAULT**".
- 2 Press "✓" to confirm. All the parameters are restored to the factory settings.



Note:

Through this command all the customized settings programmed by the user are deleted.

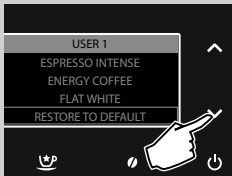

The factory setting of every beverage can be restored for each parameter.

- 1 When the desired beverage has been selected, press the "✓" button to select "**RESTORE TO DEFAULT**".
- 2 Press "✓" to confirm. All the parameters are restored to the factory settings.



Note:

Through this command all the customized settings programmed by the user for the selected product are deleted.



MACHINE PROGRAMMING

The machine allows you to customize the operating settings. These settings are applied to all user profiles.



- 1 Press the "≡" button to access the machine main menu.

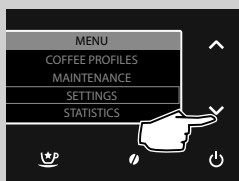

- 2 Press the "✓" button to select "SETTINGS".

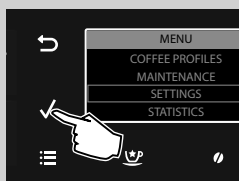

- 3 Press "✓" to confirm.



The parameters to adjust are displayed here.

To select them, press the "✓" or "∧" scrolling button.

To enter, press the "✓" button.

To return to the previous screen, press the "←" button.

To return to the initial screen, press the "≡" button.

Water settings



The **WATER SETTINGS** option allows you to adjust the water parameters for an optimal coffee.



Under **HARDNESS** you can set the water hardness level. For water hardness measuring, refer to the “Measuring and Programming Water Hardness” chapter.

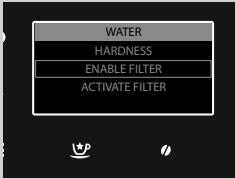

Under **ENABLE FILTER** the machine notifies the user when the water filter needs to be replaced.

OFF: Filter and warning disabled. (**Default value**) By setting the value on OFF you disable the filter and the replacement warning.

ON: Filter and warning enabled (this warning is automatically set when the filter is activated).

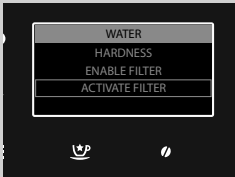

Under **ACTIVATE FILTER** you activate the filter after its installation or replacement. Refer to the chapter “INTENZA+ Water Filter Installation”.

Language Settings



This setting is important to automatically adjust the machine parameters according to the user's country.

Stand-by Settings



The **STAND-BY** sets the time lapse for the machine to go into stand-by mode after last brewing. The stand-by time ranges among 15, 30, 60 and 180 minutes.

The default time value is 30 minutes.

Factory Settings

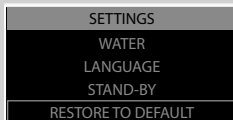

Activating the **RESTORE TO DEFAULT** option will restore all machine settings to their default values. In this case all customized parameters will be deleted.

STATISTICS

The machine allows you to see how many beverages have been brewed. This allows you to schedule the various maintenance operations indicated in the instruction manual.

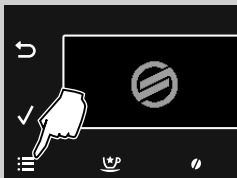

1 Press the “≡” button to access the machine main menu.

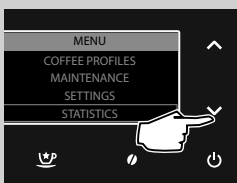

2 Press the “✓” button to select “**STATISTICS**”.

3 Press “✓” to confirm.

The amount of brewed beverages, divided for each option, will be displayed.

MAINTENANCE

In this menu you can manage all the automatic cycles necessary for the correct maintenance of the machine.

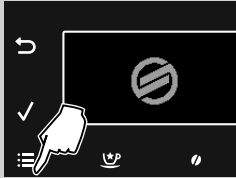

- 1 Press the “☰” button to access the machine main menu.

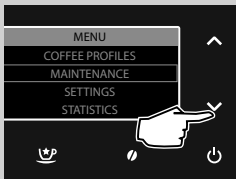

- 2 Press the “√” button to select “**MAINTENANCE**”.



- 3 Press “√” to confirm.

- 4 Press the “√” or “^” button to select the cycle to activate.

The various cycles to activate are displayed here.

Descaling

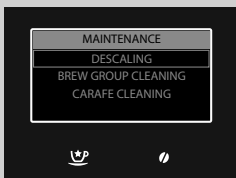

The **DESCALING** function activates the descaling cycle (see “Descaling” chapter).

Brew Group Cleaning Cycle

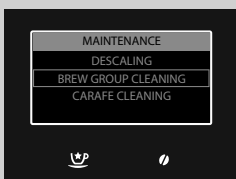

The **BREW GROUP CLEAN** function enables the brew group monthly cleaning (see “Monthly Cleaning of the Brew Group” chapter).

Cleaning of the Carafe

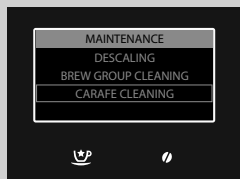

The **CARAFE Cleaning** function enables the milk carafe monthly cleaning (see "Monthly Cleaning of the Milk Carafe" chapter).

CLEANING AND MAINTENANCE

Daily Cleaning of the Machine



Caution:

Timely cleaning and maintenance of your machine is very important as it prolongs the life of your machine. The machine is continuously exposed to humidity, coffee and limescale!

The activities you need to perform and their frequency are described in detail in this chapter. Not doing this will ultimately make your machine stop working properly. This repair is NOT covered by warranty!



Note:

- Use a soft, dampened cloth to clean the machine.
- The cup holder grill, the external drip tray, the internal drip tray, the coffee grounds drawer and the parts of the carafe, indicated in the "Weekly Cleaning of the Milk Carafe" section, can be washed in the dishwasher. All other components must be washed with lukewarm water.
- Do not immerse the machine in water.
- Do not use alcohol, solvents, and/or abrasive objects to clean the machine.
- Do not dry the machine and/or its components using a microwave and/or standard oven.

Empty and clean the coffee grounds drawer and the drip tray (internal) every day with the machine turned on. Please follow the steps below:

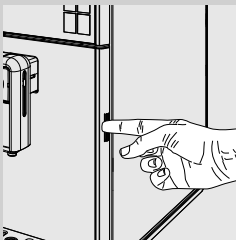

- 1** Press the button in the frame and open the service door.

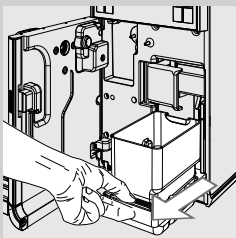

- 2** Remove the drip tray (internal) and coffee grounds drawer.

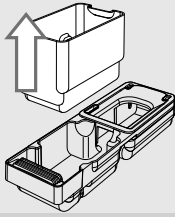

3 Empty the coffee grounds drawer and wash it with fresh water.

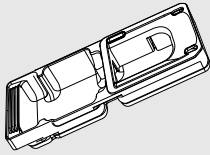

4 Empty the drip tray (internal) and the lid and wash them with fresh water.

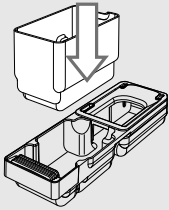

5 Correctly reinstall all the components.

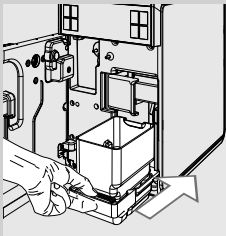

6 Insert the drip tray and the coffee grounds drawer and close the service door.

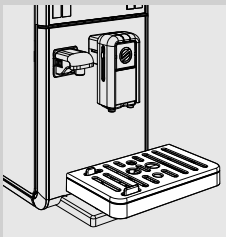

7 Remove the drip tray (external), empty it and wash it.

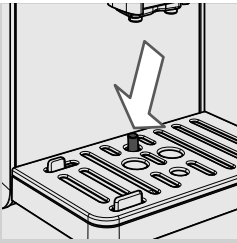
**Note:**

Perform this operation also when the full drip tray indicator is raised.

Daily Cleaning of the Water Tank

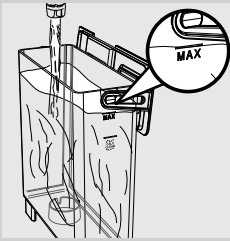

- 1** Remove the small white filter or the INTENZA+ water filter (if installed) from the water tank and wash both with fresh water.
- 2** Put the small white filter back or the INTENZA+ water filter (if installed) in its housing by gently pressing and turning it at the same time.
- 3** Fill the water tank with fresh water.

Daily Cleaning of the Milk Carafe

It is important that you clean the milk carafe daily or after each use as it preserves hygiene and ensures perfect milk froth consistency.

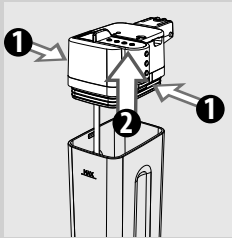
**Warning:**

Danger of scalding! Dispensing may be preceded by short sprays of hot water and steam. Danger of scalding! Wait until the end of the cycle before removing the milk carafe.

- 1** Press the release buttons to remove the top of the carafe.
- 2** Rinse the top of the carafe and the milk carafe with fresh water. Remove all milk residues.

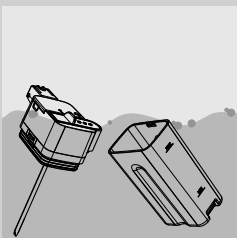

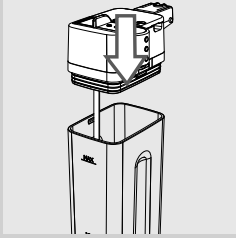

3 Attach the top on the milk carafe; ensure it is locked into place.

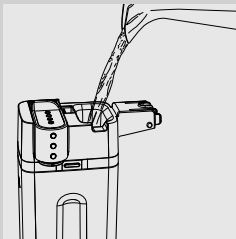

4 Remove the lid and fill the milk carafe up to the MAX level with fresh water.

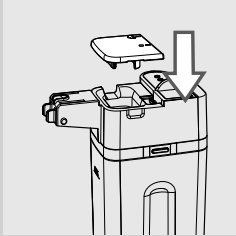

5 Put the lid back onto the milk carafe.

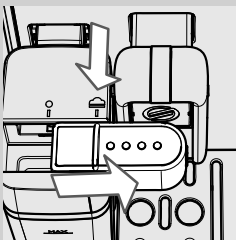

6 Pull out the milk carafe dispenser to the right up to the "☰" icon.

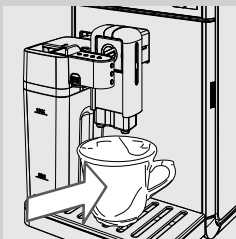

7 Place a cup under the dispensing spout.

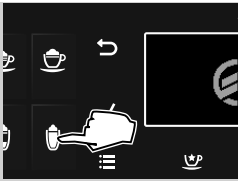

8 Press the “☺” button to start the dispensing procedure.

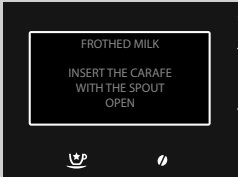

9 The machine reminds you to insert the carafe and pull out the dispensing spout.

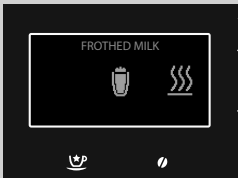

10 This icon is displayed during preheating time required by the machine.

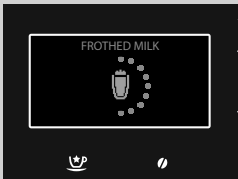

11 Once the machine stops dispensing water, the rinsing is finished.

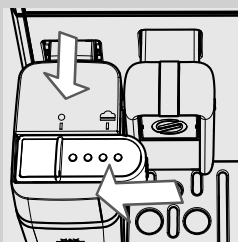

12 Insert the milk carafe dispenser back into position, scrolling it up to the “●” icon. Remove the milk carafe and empty it.

Weekly Cleaning of the Machine

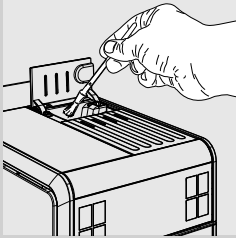

- 1 Clean the pre-ground coffee compartment with the cleaning brush.

Weekly Cleaning of the Milk Carafe

The weekly cleaning is more thorough since all milk residues are removed from the dispensing spout.

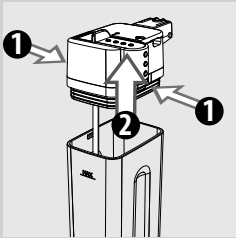

- 1 Press the release buttons to remove the top of the carafe.

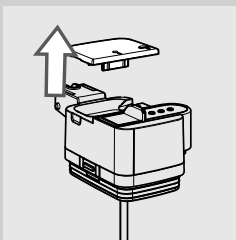

- 2 Remove the lid.

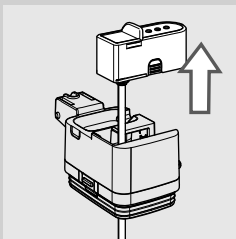

- 3 Lift the dispensing spout to remove it from the top of the carafe. The milk carafe dispenser is made up of five parts that must be disassembled. Each part is indicated by a capital letter (A, B, C, D, E) as shown in the figure below.

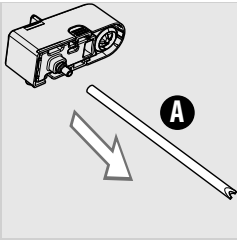

4 Remove the suction tube (A).

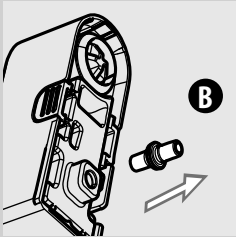

5 Remove the fitting (B) from the milk frother by pulling it outwards.

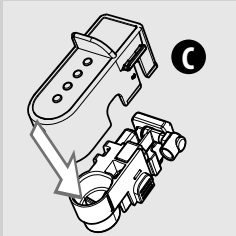

6 Detach the lid (C) from the milk carafe dispenser by slightly pressing on the sides while pushing downwards.

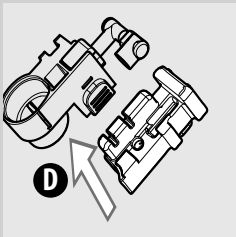

7 Disassemble further the dispenser (D) as shown in the figure.

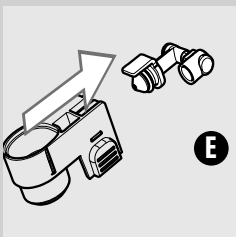

8 Remove the fitting (E) from the milk frothing device by pulling it outwards.

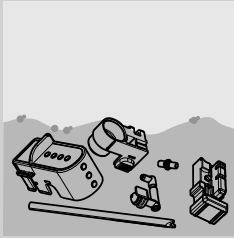

9 Clean all the parts thoroughly with lukewarm water.



Note:

You can also clean these parts in the dishwasher.

10 Reassemble the parts following the reverse order.

Weekly Cleaning of the Brew Group

The brew group should be cleaned every time the coffee bean hopper is filled or at least once a week.

1 Turn off the machine by pressing the “” button and remove the plug from the socket.

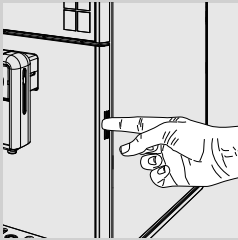

2 Press the button in the frame and open the service door.

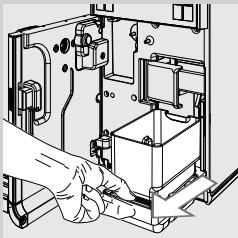

3 Remove the drip tray (internal) and coffee grounds drawer and clean them.

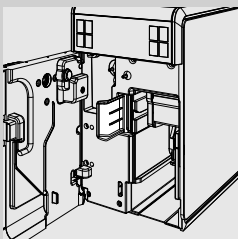

4 Open the brew group unlocking lever.

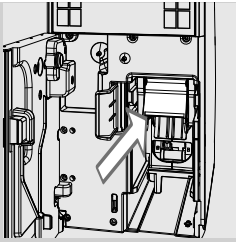

5 Seize the brew group handle and pull it outwards.

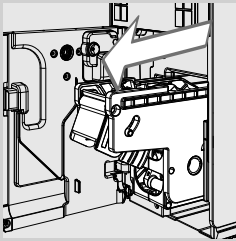

6 While pulling the lever, remove the brew group.

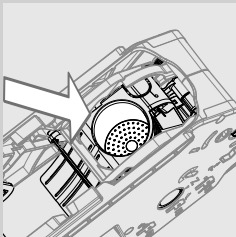

7 Thoroughly wash the brew group with lukewarm water and carefully clean the brew group filter.



Caution:

Do not use detergent or soap to clean the brew group.

8 Let the brew group air-dry thoroughly.

9 Thoroughly clean the inside of the machine using a soft, dampened cloth.

10 Thoroughly clean the upper filter using a non-abrasive cloth, to remove any coffee grounds.



Warning:

Danger of scalding! The upper filter is a hot component. Make sure that the machine has cooled down, before cleaning. Perform the operation when the machine has been turned off for at least one hour.

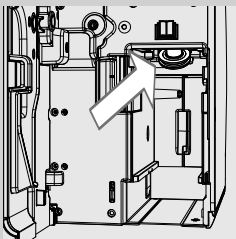

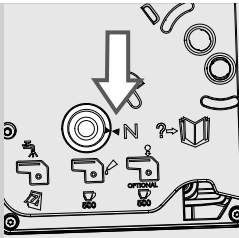

11 Make sure the brew group is in the off position; the two reference signs must match. If they do not match, proceed as described in steps (12 and 13).

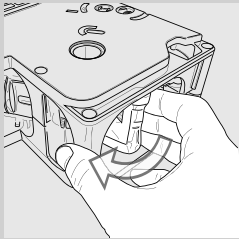

12 Turn the brew group back to the off position by manually turning the pin on the base, as shown in this figure. Turn it until it locks into the position described in the following step.

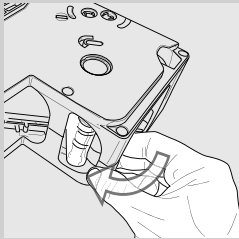

13 When you reach the position shown in this figure, check that the two reference signs match and that the brew group is locked into position.

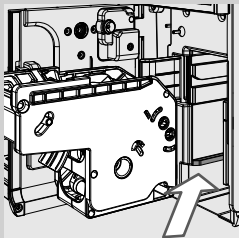

14 Insert the brew group in its seat again by sliding it along the guides until it locks into place.

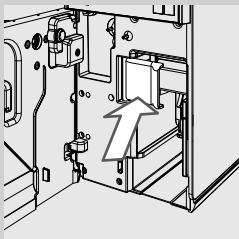

15 Close the brew group locking lever to lock it into position.

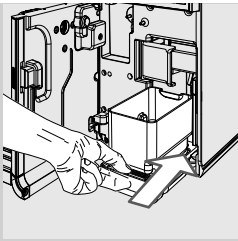

16 Insert the drip tray (internal) and coffee grounds drawer.

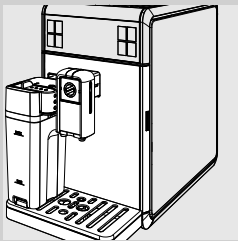

17 Close the service door.

Monthly Cleaning of the Milk Carafe

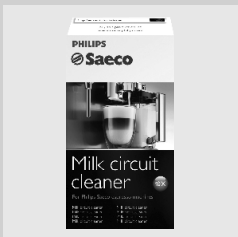



For the monthly cleaning cycle we recommend using the “Saeco Milk Circuit Cleaner” to keep the entire circuit clean of milk residues. The “Saeco Milk Circuit Cleaner” can be purchased separately. Please refer to the maintenance products page for further details.

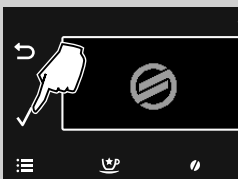

Warning:

Danger of scalding! Dispensing may be preceded by short sprays of hot water and steam. Danger of scalding! Wait until the end of the cycle before removing the milk carafe.



1 Press the  button to access the machine main menu.



2 Press the "✓" button to select "MAINTENANCE".

3 Press "✓" to confirm.



4 Press the "✓" button to select "CARAFE CLEANING".

5 Press "✓" to confirm.

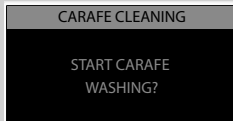

6 Press "✓" to confirm or "↶" to return to the previous menu.

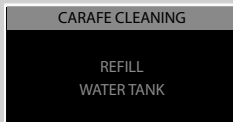

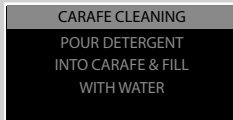

7 Fill the water tank with fresh water up to the MAX level. Press the "✓" button to confirm.



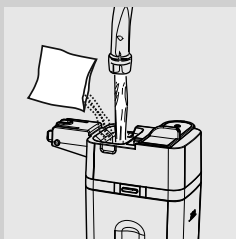

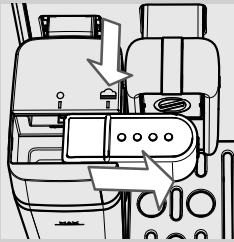
8 Pour one milk cleaner bag into the milk carafe. Fill the milk carafe with fresh drinking water up to the MAX level and then let the milk cleaner bag dissolve completely.





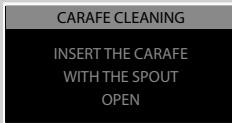

9 Insert the carafe into the machine. Scroll the milk carafe dispenser to the right up to the “” icon. Press the “” button to confirm.

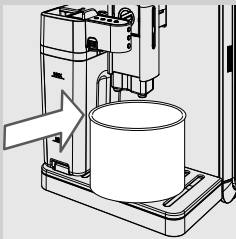
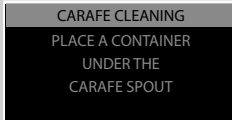

10 Press the “” button to confirm.



11 Place a suitable container (1.5 l) under the dispensing spout. Press the “” button to confirm. The machine starts dispensing the solution through the milk dispensing spout.



12 This display shows the cycle progress.



Warning:
Never drink the solution dispensed during this step.

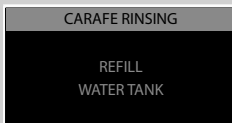

13 When the machine stops dispensing, fill the tank with fresh water up to the MAX level. Press the “” button to confirm.

CARAFE RINSING

FILL CARAFE
WITH FRESH WATER

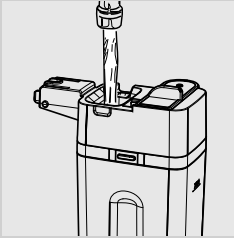

14 Remove the milk carafe and the container from the machine.

15 Rinse thoroughly the milk carafe and fill it with fresh drinking water up to the MAX level. Insert the milk carafe into the machine. Press the "✓" button to confirm.

CARAFE RINSING

INSERT THE CARAFE
WITH THE SPOUT
OPEN

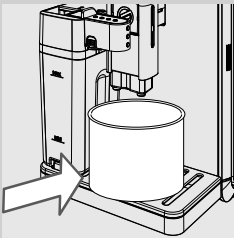

16 Empty the container and place it back under the dispensing spout. Press the "✓" button to confirm.

CARAFE RINSING

PLACE A CONTAINER
UNDER THE
CARAFE SPOUT



17 Press the "✓" button to confirm.

18 The machine will start dispensing water from the milk dispensing spout. The following display is shown.

19 At the end of the cycle, the machine returns to the products brewing menu.

20 Disassemble and wash the milk carafe as described in the "Weekly Cleaning of the Milk Carafe" chapter.

Monthly Lubrication of the Brew Group

Lubricate the brew group after approximately 500 cups of coffee or once a month.

You can purchase separately the Saeco grease to lubricate the brew group. For further details, please refer to the maintenance products page in this manual.



Caution:

Before lubricating the brew group, clean it with fresh water and dry it as described in the “Weekly Cleaning of the Brew Group” chapter.

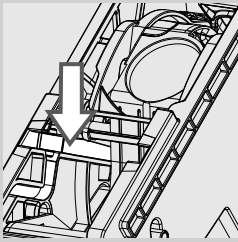

- 1 Apply the lubricant evenly on both side guides.

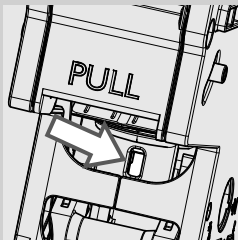
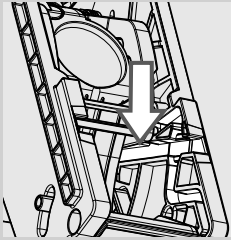

- 2 Lubricate also the piston, as shown in the figure.

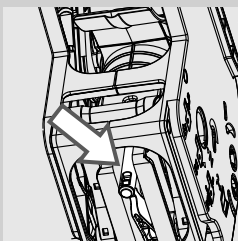

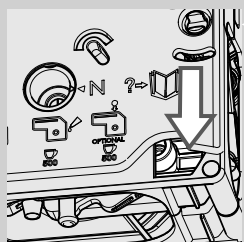
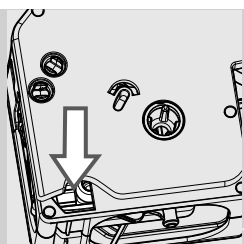

- 3** Lubricate the internal guides positioned on both sides of the brew group.
- 4** Insert the brew group in its seat until it locks into place (see “Weekly Cleaning of the Brew Group” chapter).
- 5** Insert the drip tray (internal) and the coffee grounds drawer and close the service door.

Monthly Cleaning of the Brew Group with “Coffee Oil Remover”



Besides weekly cleaning, we recommend running the cleaning cycle with “Coffee Oil Remover” after approximately 500 cups of coffee or once a month. This operation completes the maintenance process for the brew group.

You can purchase separately the “Coffee Oil Remover” and the “Maintenance Kit”. Please refer to the maintenance products page for further details.



Caution:

The “Coffee Oil Remover” tablets are to be used for cleaning only and do not have a descaling function. For the descaling procedure use the Saeco descaling solution and follow the procedure described in the “Descaling” chapter.

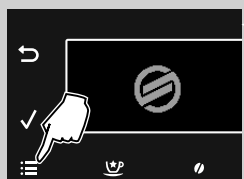

- 1** Press the  button to access the machine main menu.



2 Press the "✓" button to select **"MAINTENANCE"**.

3 Press "✓" to confirm.



4 Press the "✓" button to select **"BREW GROUP CLEANING"**.

5 Press "✓" to confirm.

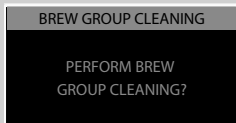

6 Press "✓" to confirm or "↶" to return to the previous menu.

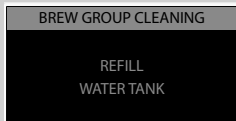

7 Fill the water tank with fresh water up to the MAX level. Press the "✓" button.

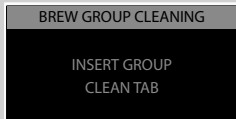

8 Put a "Coffee Oil Remover" tablet in the pre-ground coffee compartment. Press the "✓" button.

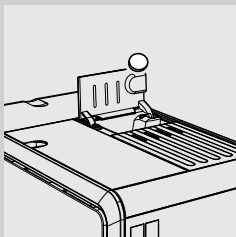

BREW GROUP CLEANING

PLACE A CONTAINER
UNDER THE
DISPENSING SPOUT

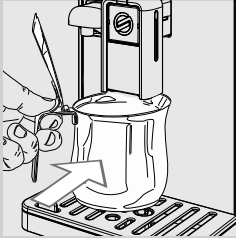

- 9** Place a container (1.5 l) under the coffee dispensing spout. Press the “✓” button to start the cleaning cycle.



Warning:

Never drink the solution dispensed during this step.

BREW GROUP CLEANING



- 10** This icon is displayed. The display shows the cycle progress.

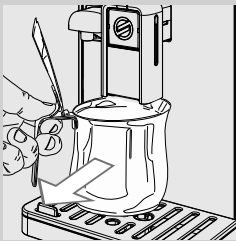

- 11** When the machine stops dispensing, remove and empty the container.

- 12** Clean the brew group as described in the “Weekly Cleaning of the Brew Group” chapter.

Monthly Cleaning of the Coffee Bean Hopper

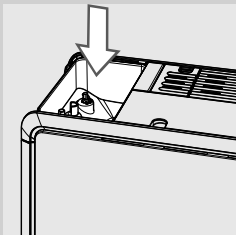

Clean the coffee bean hopper once a month with a cloth to remove any dust or coffee beans.

DESCALING

The descaling process takes approx. 35 minutes.

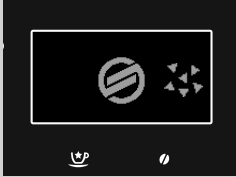

Limescale builds up inside the machine during use. It needs to be removed regularly as it may clog the water and coffee circuit. The machine tells you when descaling is needed. If the machine display shows this icon, it means that you need to descale.



Caution:

Not doing this will ultimately make your machine stop working properly, and in this case repair is NOT covered by your warranty.



Always use the specially formulated descaling solution, since it has been designed to optimize machine performance.

The descaling solution can be purchased separately. For further details, please refer to the maintenance products page in this manual.



Warning:

Never drink the descaling solution or any products dispensed until the cycle has been carried out to the end. Never use vinegar as a descaling solution.



Note:

During the descaling cycle do not switch off the machine. Otherwise you will need to restart the descaling cycle from the very beginning.

To execute the descaling cycle, follow the steps below:

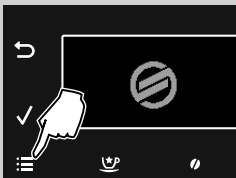

- 1 Press the "☰" button to access the machine main menu.



- 2 Press the "✓" button to select "MAINTENANCE".

- 3 Press "✓" to confirm.



4 Press "✓" to confirm the "DESCALING" selection.



Note:

If you press the "✓" button by mistake, press the "↶" button to quit.

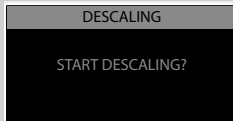

5 Press the "✓" button to confirm.

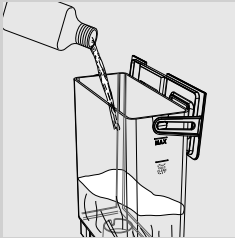
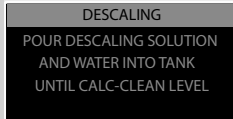

6 Remove the water tank and the "INTENZA+" water filter (if any) and insert the small white filter supplied with the machine. Pour the entire content of the Saeco descaling solution.

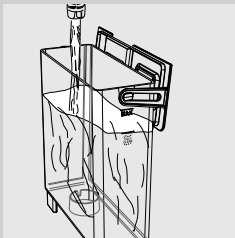

7 Fill up the tank with fresh water up to the CALC CLEAN level. Place the tank back in the machine. Press the "✓" button.



8 Empty the drip tray (internal) / (external). Press the "✓" button.

DESCALING

FILL HALF CARAFE WITH WATER. INSERT IN BREWING POSITION

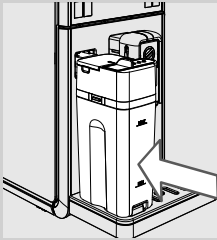

- 9 Fill half the carafe with water and insert it in the machine. Scroll the milk carafe dispenser to the right up to the "☰" icon. Press the "✓" button.

DESCALING

PLACE A CONTAINER UNDER THE DISPENSING SPOUT

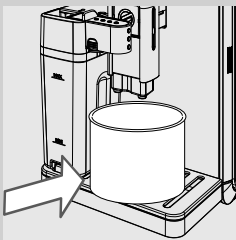

- 10 Place a large container (1.5 l) under both the milk carafe dispenser and the dispensing spout. Press the "✓" button.

DESCALING

PAUSE

- 11 The machine starts dispensing descaling solution at regular intervals. The display shows the cycle progress.

DESCALING

START

-  **Note:** to empty the container during the process and to pause the descaling cycle, press the "↶" button. To resume the cycle, press the "✓" button.

RINSING

RINSE TANK & FILL WITH WATER

- 12 The message indicates the end of the first step. The water tank needs to be rinsed. **Fill the water tank with fresh water up to the MAX level.** Press the "✓" button.

RINSING

EMPTY TRAY UNDER BREW GROUP

- 13 Empty the drip tray (internal) and place it back. Then press the "✓" button.

RINSING
FILL HALF CARAFE
WITH WATER. INSERT
IN BREWING POSITION

RINSING
PLACE A CONTAINER
UNDER THE
DISPENSING SPOUT

RINSING

PAUSE

14 Empty the milk carafe and fill half of it with fresh water. Insert it back into the machine with the dispensing spout open. Press the “✓” button.

15 Empty the container and place it back under both the milk carafe dispenser and the dispensing spout. Press the “✓” button.

16 The rinse cycle is activated.

 **Note:**

To empty the container during the process and to pause the rinse cycle, press the “D” button. To resume the cycle, press the “✓” button.

 **Note:**

The rinse cycle is performed in order to have the circuit cleaned with a preset amount of water to ensure proper machine performance. If the water tank is not filled up to MAX level, the machine could require two or more cycles.

17 When the amount of water needed for the rinse cycle has been completely dispensed, the machine automatically ends the descaling process.

 **Note:**

Wait until it has finished rinsing.

18 At the end of the descaling process, the machine performs an automatic rinse cycle. Wait until it finishes before removing and emptying the container.

19 Disassemble and wash the milk carafe as described in the “Weekly Cleaning of the Milk Carafe” chapter.

20 Empty the drip tray (internal) and place it back.





21 Remove the small white filter and place back the “INTENZA+” water filter into the water tank if it was installed.

 **Note:**

At the end of the descaling cycle, wash the brew group as described in the “Weekly Cleaning of the Brew Group” chapter.

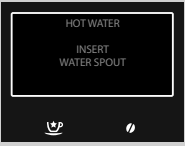
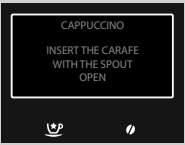
DISPLAY MESSAGES

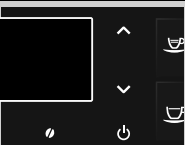
Displayed message	Meaning of the message
	Fill the coffee bean hopper.
	The brew group must be inserted into the machine.
	Insert the coffee grounds drawer and the internal drip tray.
	<p>Empty the coffee grounds drawer.</p> <p> Note: The coffee grounds drawer must be emptied only when the machine requires it and with the machine on. If the drawer is emptied with the machine turned off, the machine will not record the emptying operation.</p>
	Close the service door.
	Remove the water tank and fill it. You can fill the water tank also through the dedicated hole on the lid.
	<p>Open the service door and empty the internal drip tray.</p> <p> Note: If this operation is performed when the machine is on, it will record the coffee grounds drawer emptying and will reset the counter; therefore, it is necessary to empty the coffee grounds as well.</p>
	Insert the coffee bean hopper lid and/or beans lid.

Displayed message	Meaning of the message
	<p>Insert the water dispensing spout to start dispensing. Press "ESC" to exit.</p>
	<p>Before beginning to dispense, insert the milk carafe with the dispensing spout open.</p>
	<p>The machine needs to be descaled. Follow the steps described in the "Descaling" chapter of this manual. <u>Please note that not descaling your machine will ultimately make it stop working properly. In this case repair is NOT covered under your warranty.</u></p>
	<p>The machine needs the "INTENZA+" water filter to be replaced.</p>
	<p>The red light flashes. Press any button to exit the stand-by mode.</p>
	<p>Take note of the code (E xx) shown on the display at the bottom. Turn off the machine. After 30 seconds, turn it on again. Repeat the procedure 2 or 3 times. If the machine will not start, contact the Philips SAECO hotline in your country and quote the code shown on the display. You can find its contact details in the warranty booklet packed separately or on www.philips.com/support.</p>

TROUBLESHOOTING

This chapter summarizes the most common problems you could encounter with your machine.

If you are unable to solve the problem with the information below, visit www.philips.com/support for a list of frequently asked questions or contact the Philips Saeco hotline in your country.

The contact details can be found in the warranty booklet by-packed separately or on www.philips.com/support.

Machine actions	Causes	Solutions
The machine does not switch on.	The machine is not connected to the electric network.	Connect the machine to the electric network.
	The power button is on position "0".	Check that the power button is set to "I".
The drip tray gets filled although no water is drained.	Sometimes water is drained automatically by the machine into the drip tray to manage the rinsing of the circuits and ensure optimum machine performance.	This is seen as normal machine behaviour.
Coffee is not hot enough.	The cups/mugs are cold.	Preheat the cups/mugs with hot water or use the hot water dispensing spout.
	The beverage temperature in the programming menu is set on Low.	Make sure that the temperature in the programming menu is set on Normal or High.
	You added cold milk to the coffee.	Cold milk lowers the temperature of the final product. Preheat the milk before adding it to the beverage.
No hot water is dispensed.	The hot water/steam dispensing spout is clogged or dirty.	Clean the hot water dispensing spout. Inspect the steam spout to check that the dispensing spout is not clogged. Make a hole in the limescale using a pin or a needle.
The machine does not fill the cup/mug.	The machine has not been programmed.	Enter the beverage programming menu and adjust the coffee length setting according to your personal taste for each type of beverage.
Coffee does not have enough crema (see note).	The blend is unsuitable, coffee is not freshly roasted or the grind is too coarse.	Change coffee blend or adjust the grind as explained in the "Adjusting the Ceramic Coffee Grinder" chapter.
	The coffee beans or the pre-ground coffee are too old.	Make sure that you use fresh coffee beans or pre-ground coffee.

Machine actions	Causes	Solutions
Milk does not froth.	The milk dispensing spout has not been pulled out	Check that the milk dispensing spout has been pulled out correctly up to the "  " icon
	The carafe has not been correctly reassembled or with all its components.	Make sure the wand is correctly inserted. All its components have to be correctly reassembled, as described in the "Weekly cleaning of the Milk Carafe" section.
The machine takes a long time to warm up or the amount of water dispensed from the wand is too little.	The machine circuit is clogged by limescale.	Descale the machine.
The brew group cannot be removed.	The brew group is out of place.	Turn the machine on. Close the service door. The brew group automatically returns to the initial position.
	The coffee grounds drawer is inserted.	Remove the coffee grounds drawer before removing the brew group.
There is too much ground coffee under or over the brew group.	The coffee used may not be suitable for automatic machines.	It may be necessary to change the type of coffee or the coffee grinder settings (see "Adjusting the Ceramic Coffee Grinder" chapter).
	The machine is adjusting the coffee grinder for a new kind of coffee beans or pre-ground coffee.	The machine automatically adjusts itself after brewing several cups of coffee to optimise the extraction in relation to the compactness of the ground coffee. It may be necessary to brew 2 or 3 products for the coffee grinder to adjust completely. This is not a malfunction of the machine.
The machine produces too humid or too dry coffee grounds.	Adjust the coffee grinder.	Adjusting the ceramic coffee grinder affects the quality of residues. If the residues are too humid, set a coarser grind. If the residues are too dry, set a finer grind. Refer to the "Adjusting the Ceramic Coffee Grinder" chapter.
The machine grinds the coffee beans but no coffee is brewed (see note).	There is no water.	Fill the water tank and prime the circuit (see the "Manual Rinse Cycle" chapter).
	The brew group is dirty.	Clean the brew group (see the "Weekly Cleaning of the Brew Group" chapter).
	This might occur when the machine is automatically adjusting the dose.	Brew a few coffees as described in chapter "Saeco Adapting System".
	The dispensing spout is dirty.	Clean the dispensing spout.

Machine actions	Causes	Solutions
The coffee is too weak (see note).	This might occur when the machine is automatically adjusting the dose.	Brew a few coffees as described in chapter "Saeco Adapting System".
	The ground coffee is too coarse.	Change coffee blend or adjust the grind as explained in the "Adjusting the Ceramic Coffee Grinder" chapter.
Coffee is brewed slowly (see note).	The ground coffee is too fine.	Change coffee blend or adjust the grind as explained in the "Adjusting the Ceramic Coffee Grinder" chapter.
	Circuits clogged.	Perform a descaling cycle.
	The brew group is dirty.	Clean the brew group (see the "Weekly Cleaning of the Brew Group" chapter).
Coffee leaks out of the dispensing spout.	The dispensing spout is clogged or not correctly inserted.	Clean the dispensing spout and its holes and insert it back correctly.

**Note:**

these problems can be considered normal if the coffee blend has been changed or if the machine has just been installed. In this case wait until the machine performs a self-adjusting operation as described in the "Saeco Adapting System" chapter.

ENERGY SAVING

Stand-by

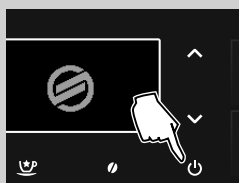
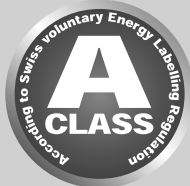

The Saeco full automatic espresso machine is designed for energy saving proven by the Class A energy label.

After a certain time of inactivity that can be set by the user (see chapter “Machine Programming”), the machine turns off automatically. If a product has been brewed the machine performs a rinse cycle.

In stand-by mode, the energy consumption is below 1Wh.

To turn on the machine, press the “” button for a few seconds (if the power button on the back of the machine is set to “I”). If the boiler is cold the machine performs a rinse cycle.

The machine status can be manually changed to stand-by mode by holding the STAND-BY button for 3 seconds.

**Note:**

- 1 The stand-by mode cannot be activated if the service door is left open.
- 2 When the stand-by mode is activated, the machine may perform a rinse cycle. The cycle can be interrupted by pressing the “” button.

The machine can be turned on again by:

- 1 Pressing any button on the control panel.
- 2 Opening the service door (when closing the door the machine goes back to stand-by mode).

The red indicator light on the “” button flashes when the machine is in stand-by mode.

Disposal



Do not throw away the machine with the normal household waste at the end of its life, but hand it in at an official collection point for recycling. By doing this, you help to preserve the environment.

- Packaging materials can be recycled.
- Machine: unplug the machine and cut the power cord.
- Deliver the appliance and power cord to a service centre or public waste disposal facility.

This product complies with EU Directive 2002/96/EC.

The symbol on the product or on its packaging indicates that this product may not be treated as household waste. Instead, it shall be handed over to the applicable collection point for the recycling of electrical and electronic equipment.

By ensuring this product is disposed of correctly, you will help prevent potential negative consequences for the environment and human health, which could otherwise be caused by inappropriate waste handling of this product. For more detailed information about recycling of this product, please contact your local city office, your household waste disposal service or the shop where you purchased the product.

TECHNICAL SPECIFICATIONS

The manufacturer reserves the right to make changes to the technical specifications of the product

Nominal Voltage - Power Rating - Power Supply	See data plate on the appliance
Housing material	Thermoplastic Material/Metal
Size (w x h x d)	210 x 360 x 460 mm
Weight	12.5 kg
Power cord length	800-1200mm
Control panel	Front panel
Cup Size	110 mm
Water Tank	1.7 litres - Removable type
Coffee bean hopper capacity	270 g
Coffee grounds drawer capacity	20
Pump pressure	15 bar
Boiler	Stainless Steel
Safety devices	Boiler pressure safety valve – Double safety thermostat - Thermal fuse

WARRANTY AND SERVICE

Warranty

For detailed information on your warranty and related conditions, please read the warranty booklet supplied separately.

Service

We want to ensure that you remain satisfied with your machine. If not done already, please register your purchase at **www.philips.com/welcome**. This will enable us to stay in contact with you and send you cleaning and descaling reminders.

If you need service or support, please visit the Philips website at **www.philips.com/support** or contact the Philips Saeco hotline in your country.

You find its phone number in the warranty booklet by packed separately or on **www.philips.com/support**.

ORDERING MAINTENANCE PRODUCTS

For cleaning and descaling, use Saeco maintenance products only. You can purchase these at the Philips online shop at www.shop.philips.com/service, your local dealer or at authorised service centres.

If you have any difficulties obtaining maintenance products for your machine, please contact the Philips Saeco hotline in your country.

The contact details can be found in the warranty booklet supplied separately or on www.philips.com/support.

Overview of maintenance products



- Descaling solution CA6700



- INTENZA+ Water Filter CA6702

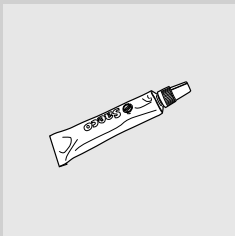

- Grease HD5061



- Coffee Oil Remover CA6704



- Milk Circuit Cleaner CA6705



- Maintenance Kit CA 6706

Blank sheet of lined paper with horizontal ruling lines.



The manufacturer reserves the right to make changes without prior notice.

www.philips.com/saeco



421946003701

Rev.01 24-09-13