

PHILIPS

FC8796, FC8794,
FC8792

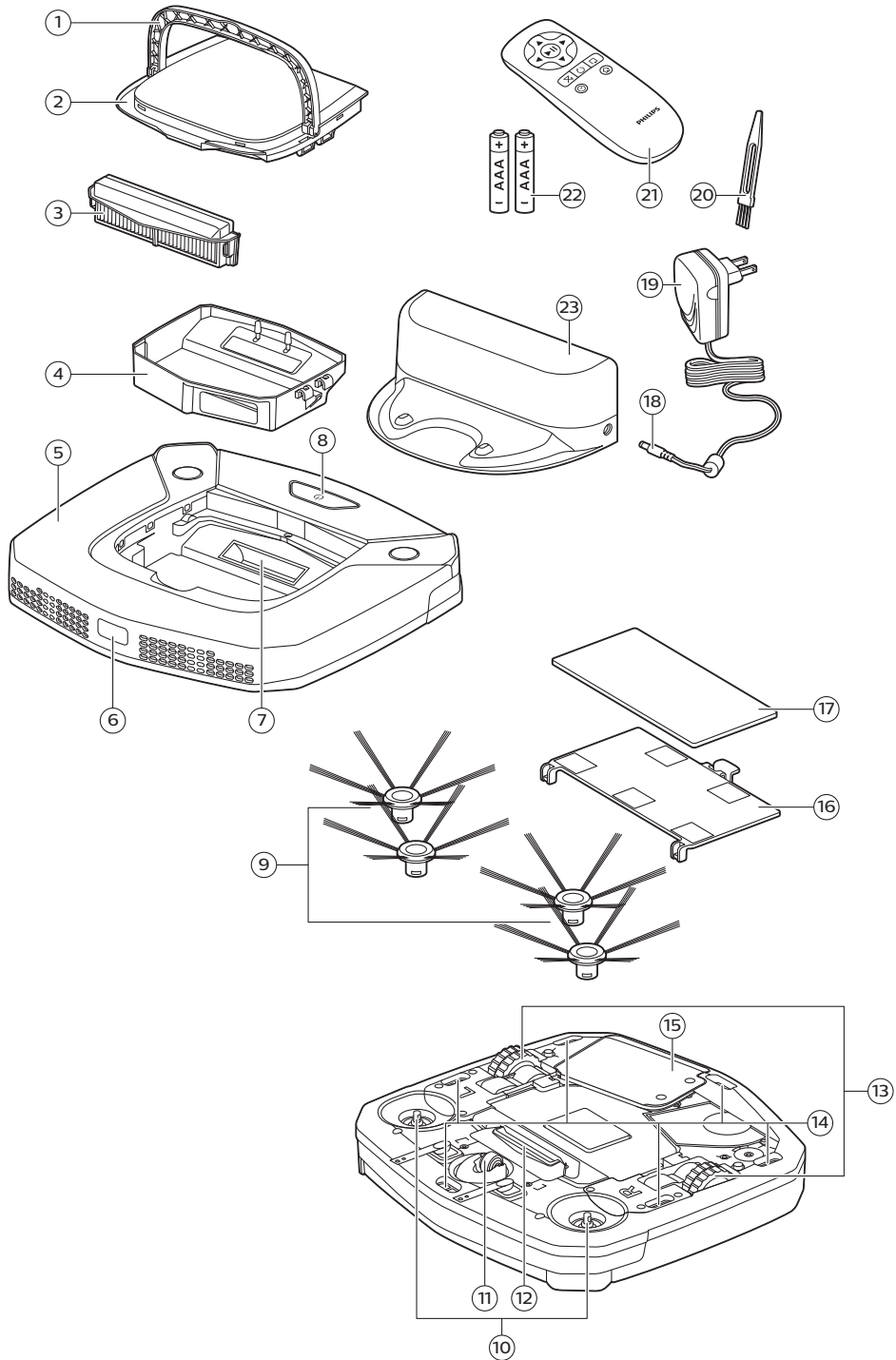





English 6
简体中文 16

Introduction

Introduction

Congratulations on your purchase and welcome to Philips! To fully benefit from the support that Philips offers, register your product at www.philips.com/welcome.

General description

- 1 Handle of dust container lid
- 2 Dust container lid
- 3 Filter unit
- 4 Dust container
- 5 Edge of top cover
- 6 Docking station sensor
- 7 Suction opening
- 8 Start/stop button
- 9 Side brushes
- 10 Shafts for mounting the side brushes
- 11 Front wheel
- 12 Suction opening
- 13 Side wheels
- 14 Sensors
- 15 Cover of the battery compartment
- 16 Mopping attachment (FC8796, FC8794)
- 17 Mopping pad (FC8796, FC8794)
- 18 Small plug
- 19 Adapter
- 20 Cleaning brush
- 21 Remote control
- 22 AAA batteries for remote control
- 23 Docking station

Remote control

You can operate the robot with the remote control (Fig. 2). It has the following buttons:

- 1 Start/stop button
- 2 Navigation buttons
- 3 Cleaning mode buttons
- 4 Docking button
- 5 24-hour scheduler

How your robot works

What your robot cleans

This robot is equipped with features that make it a suitable cleaner to help you clean the floors in your home.

The robot is especially suitable for cleaning hard floors, such as wooden, tiled or linoleum floors. It may experience problems cleaning soft floors, such as carpet or rugs. If you use the robot on a carpet

or rug, please stay close by the first time to see if the robot can deal with this type of floor. The robot also needs supervision when you use it on very dark or shiny hard floors.

How your robot cleans

Cleaning system

The robot has a 3-stage cleaning system to clean your floors efficiently.

- The two side brushes help the robot clean in corners and along walls. They also help to remove dirt from the floor and move it towards the suction opening (Fig. 3).
- The suction power of the robot picks up loose dirt and transports it through the suction opening into the dust container (Fig. 4).
- Types FC8796 and FC8794 come with a mopping attachment that can be attached to the robot to mop your hard floor.

Cleaning patterns

In its auto cleaning mode, the robot uses an automatic sequence of cleaning patterns to clean each area of the room optimally. The cleaning patterns it uses are:

- 1 Random pattern (Fig. 5)
- 2 Wall-following pattern (Fig. 6)
- 3 Spot-cleaning pattern (Fig. 7)

In its auto cleaning mode, the robot uses these patterns in a fixed sequence: random pattern, wall-following pattern, and spot-cleaning pattern.

When the robot has completed this sequence of patterns, it starts moving in random pattern again. The robot continues to use this sequence of patterns to clean the room until the rechargeable battery runs low, or until it is switched off manually.

Note: You can also select each mode individually by pressing the appropriate button on the remote control (see 'Cleaning mode selection'). The robot continues cleaning in the selected cleaning mode until you switch the robot off and on again.

How your robot avoids height differences

The robot has five drop-off sensors in its bottom. It uses these drop-off sensors to detect and avoid height differences such as staircases.

Note: It is normal for the robot to move slightly over the edge of a height difference, as its front drop-off sensor is located behind the bumper.

Caution: In some cases, the drop-off sensors may not detect a staircase or other height difference in time. Therefore monitor the robot carefully the first few times you use it, and when you operate it near a staircase or another height difference. It is important that you clean the drop-off sensors regularly to ensure the robot continues to detect height differences properly (see 'Cleaning the robot').

Before first use

Mounting the side brushes

- 1 Unpack the side brushes and place the robot upside down on a table or on the floor.
- 2 Push the side brushes onto the shafts on the bottom of the robot (Fig. 8).

8 English

Note: Make sure you attach the side brushes properly. Press them onto the shaft until you hear them lock into position with a click.

Placing the batteries in the remote control

The remote control works on two AAA batteries.

- 1 Push the tab (1) to unlock the battery compartment lid (2) and remove the battery compartment lid (Fig. 9).
- 2 Insert two AAA batteries (Fig. 10).

Note: Make sure the + and - poles point in the right direction.

- 3 To reattach the battery compartment lid, first insert the lug into the opening in the rim of the compartment (1) and then push down the lid (2) until it locks with a click (Fig. 11). Now the remote control is ready for use.

Preparing for use

Installing the docking station

- 1 Insert the small plug of the adapter into the socket on the docking station (1) and insert the adapter into the wall socket (2) (Fig. 12).
- 2 Place the docking station on a horizontal, level floor against a wall.

Note: Make sure that there are no obstacles or height differences 150 cm in front, 30 cm to the right and 100 cm to the left of the docking station (Fig. 13).

Charging

- 1 Place the robot on the plugged-in docking station (Fig. 14).
- 2 The start/stop button starts flashing (Fig. 15).
- 3 When the rechargeable battery is fully charged, the start/stop button lights up continuously (Fig. 16).

Preparing the room for a cleaning run

- Before you start the robot on its cleaning run, make sure that you remove all loose and fragile objects from the floor (Fig. 17).
- Remove all cables, wires and cords from the floor to prevent the robot from getting entangled in them.
- If there is a rug with tassels in the room you want the robot to clean, fold the tassels under the rug to prevent the robot from getting stuck on the tassels and to prevent the rug from getting damaged (Fig. 18).

Using your robot

Using the remote control

- 1 Place the robot on the docking station or press the start/stop button on the robot (Fig. 19) to activate the robot.
 - Now you can use the remote control to operate the robot.

Starting and stopping

- 1 Press the start/stop button on the remote control (Fig. 20).
- 2 The start/stop button on the robot lights up continuously and the robot starts cleaning (Fig. 21).
- 3 The robot cleans in auto-cleaning mode until its battery runs low. In auto cleaning mode, it follows repeated sequences of random, wall-following and spiral movements.
- 4 When the battery runs low, the start/stop button starts flashing quickly and the robot starts searching for the docking station to charge (Fig. 22).
- 5 You can also press the start/stop button to interrupt or stop the cleaning run. If you press the start/stop button again and there is still enough energy in the rechargeable battery, the robot continues cleaning in the auto cleaning mode.
- 6 To make the robot return to the docking station before the rechargeable battery runs low, press the docking button on the remote control (Fig. 23).
- 7 The start/stop button starts flashing and the robot returns to the docking station.

Cleaning mode selection

This robot has three individual cleaning modes that can each be activated by pressing the appropriate button on the remote control.

Random mode

In this mode, the robot cleans the room in a mixed pattern of straight and crisscross movements (Fig. 24).

Wall-following mode

In this mode, the robot follows the walls of the room to give the area alongside the walls an extra clean (Fig. 25).

Spot-cleaning mode

In this mode, the robot moves in an expanding spiral from a central point to clean the area thoroughly (Fig. 26).

Note: The manually selected modes are only active for a couple of minutes. After that, the robot switches to auto-cleaning mode.

Manual driving

You can drive the robot manually with buttons on the remote control.

- 1 Use the arrow buttons above and below and to the left and right of the start/stop button on the remote control to navigate the robot through the room. (Fig. 27)

Note: Be careful when you drive the robot manually close to height differences and staircases.

Using the 24-hour scheduler

The 24-hour scheduler can be activated with the remote control. Make sure the robot is in standby mode and is not positioned on the docking station.

- 1 Press the 24-hour scheduler button (Fig. 28) on the remote control to activate the 24-hour scheduler.
 - When you activate the 24-hour scheduler, you hear a sound and the display starts to flash briefly every few seconds.

10 English

- The robot will start a cleaning run 24 hours after you activated the 24-hour scheduler. It will continue to start a cleaning run at the same time every 24 hours until you deactivate the 24-hour scheduler.
- 2 To deactivate the 24-hour scheduler, press the 24-hour scheduler button. You will hear a sound and the display will light up continuously to show the robot is in standby mode and the 24-hour scheduler is no longer active.

Mopping with the robot

Types FC8796 and FC8794 come with a mopping attachment and a mopping pad for wet cleaning of hard floors.

Attaching the mopping pad

- 1 Soak the mopping pad in water or wet the mopping pad under the tap. You can add a few drops of a readily available floor cleaner that is suitable for your floor.
- 2 Squeeze the mopping pad thoroughly to ensure it is only damp instead of wet.
- 3 Attach the damp mopping pad to the mopping attachment by pushing the Velcro fasteners of the mopping pad onto Velcro fasteners of the mopping attachment (Fig. 29).
- 4 Insert the attachment lugs of the mopping attachment into the two attachment holes located just behind the wheels. Then press down until you hear a click (Fig. 30).

Cleaning floors with the mopping attachment

Note: To clean hard floors with the mopping attachment, you have to start the robot from a point in the room you wish to clean. You cannot start the robot from its docking station with the mopping pad attached.

- 1 Just press the start/stop button on the remote control to start the robot.
 - The robot continues mopping until its battery runs low and the robot stops.

Note: Detach the mopping pad and the mopping attachment before you send the robot to the docking station with the docking button on the remote control or before you place the robot on the docking station manually.

Detaching the mopping attachment

- 1 To detach the mopping attachment, press the tab (1) and pull up the mopping attachment to remove it (2) (Fig. 31).
- 2 Pull the mopping pad off the mopping attachment.
- 3 To clean the mopping pad, wash it in the washing machine on a gentle cycle at a temperature of 60°C max.

Alarm signal

If the robot gets into trouble while cleaning (e.g., because a wheel jams or is no longer in contact with the floor, or because a sensor can no longer detect the floor), you will hear a sound and the robot stops. Press the start/stop button to switch the robot to standby mode and solve the problem that causes the alarm signal, for instance by removing the obstacle that blocks the wheel, cleaning the sensors, or picking up the robot and putting it down in a different place.

Cleaning and maintenance

Emptying and cleaning the dust container

Empty and clean the dust container when the dust container is full.

- 1 Pull up the handle of the dust container lid and lift the dust container out of the dust container compartment (Fig. 32).
- 2 Pull the tab on the side of the dust container to open the lid (Fig. 33).
- 3 Remove the filter unit from the dust container (Fig. 34).
- 4 Shake the dust container over a dustbin to empty it (Fig. 35).
- 5 You can clean the dust container under a lukewarm tap.

Caution: Do not clean the dust container in the dishwasher.

- 6 To clean the filters thoroughly, take the filter unit apart by pressing the tabs located on both sides of the filter unit and taking the dust filter off the EPA filter. Then clean the EPA filter with the cleaning brush supplied (Fig. 36).
- 7 Reassemble the filter unit, snap the EPA filter into the dust filter. Then place the filter unit back into the dust container (Fig. 37).

Note: If you cleaned the dust container under the tap, please make sure it is dry before you reinsert the filter unit.

- 8 Put the lid on the dust container and make sure it locks into place with a click (Fig. 38).
- 9 Put the dust container back into the dust container compartment and fold down the dust container handle (Fig. 39).

Caution: Always make sure the filter unit is present inside the dust container. If you use the robot without the filter unit inside the dust container, the motor will be damaged.

Cleaning the robot

To maintain good cleaning performance, you have to clean the drop-off sensors, the wheels, the side brushes and the suction opening from time to time.

- 1 Place the robot upside down on a flat surface.
- 2 To clean the side brushes, grab them by the bristles and pull them off their shafts (Fig. 40).
- 3 Clean the side brushes and the shafts of the side brushes with the cleaning brush supplied (Fig. 41).
- 4 Remove dust or fluff from the front wheel and side wheels with the cleaning brush supplied (Fig. 42).
- 5 Remove dust or fluff from the dust or fluff from the drop-off sensors with the cleaning brush supplied (Fig. 43).

Note: It is important that you clean the drop-off sensors regularly. If the drop-off sensors are dirty, the robot may fail to detect height differences or staircases.

- 6 Use the cleaning brush supplied to clean the suction opening (Fig. 44).
- 7 Check the side brushes and the bottom of the robot for any sharp objects that could damage your floor.

Ordering accessories

To buy accessories or spare parts, visit www.shop.philips.com/service or go to your Philips dealer. You can also contact the Philips Consumer Care Center in your country (see the international warranty leaflet for contact details).

Replacement

Replacing the filter

Replace the EPA filter if it is very dirty or damaged (see 'Emptying and cleaning the dust container'). To obtain a new EPA filter, go to www.philips.com/support.

Replacing the rechargeable battery

The rechargeable battery of the robot may only be replaced by qualified service engineers. Take the robot to an authorized Philips service center to have the battery replaced when you can no longer recharge it or when it runs out of power quickly. You can find the contact details of the Philips Consumer Care Center in your country in the international warranty leaflet.

Replacing the side brushes

Replace the side brushes after some time to ensure proper cleaning results.

Note: Always replace the side brushes when you notice signs of wear or damage. We also recommend that you replace both side brushes at the same time. To obtain new side brushes, go to www.philips.com/support.

- 1 To replace the side brushes, grab the old side brushes by the bristles and pull them off their shafts.
- 2 Push the new side brushes onto the shafts.

Replacing the batteries of the remote control

- 1 Push the tab (1) to unlock the battery compartment lid (2) and remove the battery compartment lid (Fig. 9).
- 2 Remove the empty AAA batteries from the battery compartment.
- 3 Insert two new AAA batteries (Fig. 10).

Note: Make sure the + and - poles point in the right direction.

- 4 To reattach the battery compartment lid, first insert the lug into the opening in the rim of the compartment (1) and then push down the lid (2) until it locks with a click (Fig. 11). Now the remote control is ready for use.

Note: Dispose of empty disposable batteries according to the local rules in your country.

Recycling

- Do not throw away the product with the normal household waste at the end of its life, but hand it in at an official collection point for recycling. By doing this, you help to preserve the environment.
- This product contains a built-in rechargeable battery which shall not be disposed of with normal household waste. Please take your product to an official collection point or a Philips service center to have a professional remove the rechargeable battery.
- Follow your country's rules for the separate collection of electrical and electronic products and rechargeable batteries. Correct disposal helps prevent negative consequences for the environment and human health.

Removing the rechargeable battery

Only remove the rechargeable battery when you discard the product. Before you remove the battery, make sure that the product is disconnected from the wall socket and that the battery is completely empty.

Take any necessary safety precautions when you handle tools to open the product and when you dispose of the rechargeable battery.

Removing the rechargeable battery

Warning: Only remove the rechargeable battery when you discard the appliance. Make sure the battery is completely empty when you remove it.

To remove the rechargeable battery, follow the instructions below. You can also take the robot to a Philips service center to have the rechargeable battery removed. Contact the Philips Consumer Care Center in your country for the address of a service center near you.

- 1 Let the robot run until the rechargeable battery is empty to make sure that the rechargeable battery is completely discharged before you remove it and dispose of it.
- 2 Undo the screws of the battery compartment lid and remove the lid (Fig. 45).
- 3 Lift out the rechargeable battery and disconnect it (Fig. 46).
- 4 Take the robot and the rechargeable battery to a collection point for electrical and electronic waste.

Troubleshooting

This chapter summarizes the most common problems you could encounter with the appliance. If you are unable to solve the problem with the information below, visit www.philips.com/support for a list of frequently asked questions or contact the Consumer Care Center in your country.

Problem	Possible cause	Solution
The robot does not start cleaning when I press the start/stop button.	The rechargeable battery is empty.	Charge the rechargeable battery (see 'Preparing for use').
The robot does not respond when I press one of the buttons.	The robot could not find the docking station and the battery ran out.	Place the robot on the plugged-in docking station. After a few seconds, the robot beeps and the display lights up.
The robot beeped and stopped.	One or both wheels are stuck.	Press the start/stop button. Remove the fluff, hair, thread or wire that is caught around the wheel suspension.
	One or both side brushes are stuck.	Clean the side brushes (see 'Cleaning the robot').
	The robot was lifted while it was cleaning.	Press the start/stop button. Place the robot on the floor. Then press the start/stop button to make the robot resume cleaning.

14 English

Problem	Possible cause	Solution
The robot does not clean properly.	The bristles of one or both side brushes are crooked or bent.	Soak the brush or brushes in warm water for a while. If this does not restore the bristles to their proper shape, replace the side brushes (see 'Replacing the side brushes').
	The filter in the dust container is dirty.	Disassemble the filter unit. Clean the dust filter and the EPA filter with a toothbrush with soft bristles. You can also rinse the dust filter under a tap. If cleaning the EPA filter does not help anymore, replace the filter with a new one. We advise you to replace the EPA filter at least once a year.
	The suction opening in the bottom of the dust container is clogged.	Clean the suction opening (see 'Cleaning the robot').
	The front wheel is jammed with hair or other dirt.	Clean the front wheel (see 'Cleaning the robot').
	The robot is cleaning a very dark or shiny surface, which triggers the drop-off sensors. This causes the robot to move in an unusual pattern.	Press the start/stop button and then move the robot to a lighter colored piece of the floor. If the problem continues to occur on lighter colored floors, please go to www.philips.com/support or contact the Consumer Care Center in your country.
	The robot is cleaning a floor that reflects sunlight quite strongly. This triggers the drop-off sensors and causes the robot to move in an unusual pattern.	Close the curtains to block sunlight from entering the room. You can also start cleaning when the sunlight is less bright.
The rechargeable battery can no longer be charged or runs empty very fast.	The rechargeable battery has reached the end of its life.	Have the rechargeable battery replaced by a Philips service center (see 'Replacing the rechargeable battery').
The robot is moving in circles.	The robot is in spot-cleaning mode.	This is normal behavior. The spot-cleaning mode can be activated when a lot of dirt is detected on the floor for a thorough clean. It is also part of the auto cleaning mode. After approximately one minute the robot resumes its normal cleaning pattern. You can also stop the spot-cleaning mode by selecting a different cleaning mode on the remote control. You can also stop the spot-cleaning mode by selecting a different cleaning mode on the remote control.

Problem	Possible cause	Solution
The robot cannot find the docking station.	There is not enough room for the robot to navigate towards the docking station.	Try to find another place for the docking station (see 'Installing the docking station').
	The robot is still actively searching.	Give the robot around 20 minutes to return to the docking station.

说明

简介

感谢您的惠顾，欢迎光临飞利浦！为了让您能充分享受飞利浦提供的支持，请在 www.philips.com/welcome 上注册您的产品。

基本说明

- 1 集尘桶盖手柄
- 2 集尘桶盖
- 3 滤网部件
- 4 集尘桶
- 5 顶盖边缘
- 6 底座传感器
- 7 吸口
- 8 启动/停止按钮
- 9 侧毛刷
- 10 用于安装侧毛刷的轴
- 11 前轮
- 12 吸口
- 13 侧轮
- 14 传感器
- 15 电池仓盖
- 16 拖地附件 (FC8796, FC8794)
- 17 清洁布 (FC8796, FC8794)
- 18 小插头
- 19 适配器
- 20 清洁刷
- 21 遥控器
- 22 遥控器的 AAA 电池
- 23 底座

遥控器

您可以使用遥控器 (图 2) 操作智能自动真空吸尘器。它具有以下按钮：

- 1 启动/停止按钮
- 2 导航按钮
- 3 清洁模式按钮
- 4 插接按钮
- 5 24 小时调度器

扫地机器人如何工作

扫地机器人清洁哪些物体

本扫地机器人具有许多功能，是一款适合帮助您在家中清洁地板的理想清洁工具。

此扫地机器人尤其适合清洁硬地板，例如木制、瓷砖或油毡地板。清洁软地板时可能会出现一些问题，例如地毯或地垫。如果您在地毯或地垫上使用扫地机器人，请在第一次使用之前先留心观察扫地机器人是否能够处理这种类型的地板。另外，当您在极暗或有光泽的坚硬地板上使用扫地机器人时，需要对其加以监控。

智能自动真空吸尘器如何清洁

清洁系统

智能自动真空吸尘器利用 3 重清洁系统来高效清洁地面。

- 两个侧毛刷有助于智能自动真空吸尘器清洁角落以及墙角沿线。它们还可帮助清除地板上的灰尘，并将其移向吸口 (图 3)。
- 智能自动真空吸尘器的吸力可吸入松动的污垢，然后通过吸口将污垢输送到集尘桶 (图 4)。
- FC8796 和 FC8794 类型都附带一个可连接到智能自动真空吸尘器的拖地附件，用于对硬地板进行拖地清洁工作。

清洁方向图

在自动清洁模式下，智能自动真空吸尘器会使用自动的清洁方向图顺序，以最适宜的方式清洁房间内的各个区域。所使用的清洁方向图包括：

- 1 随机方向图 (图 5)
- 2 沿墙方向图 (图 6)
- 3 局部清洁方向图 (图 7)

在自动清洁模式下，智能自动真空吸尘器以固定顺序使用这些方向图：随机方向图、沿墙方向图和局部清洁方向图。

如果智能自动真空吸尘器已按此顺序使用完方向图，则将重新以随机方向图开始移动。智能自动真空吸尘器会继续按该顺序使用方向图来清洁房间，直至充电电池的电量不足或者将其手动关闭。

注意：您还可以按遥控器 (请参见 '清洁模式选择') 上的相应按钮，分别选择各个模式。智能自动真空吸尘器持续以选择的清洁模式进行清洁，直至您将其关闭然后重新打开。

智能自动真空吸尘器如何避开高度差

智能自动真空吸尘器底部配有五个跌落传感器。智能自动真空吸尘器使用这些跌落传感器检测和避开楼梯等有高度差的地方。

注意：智能自动真空吸尘器轻轻移动以越过高度差的边缘是正常现象，因为正面的跌落传感器位于缓冲装置后面。

警告：在某些情况下，跌落传感器可能无法及时检测到楼梯或其他有高度差的地方。因此，在最初几次使用以及在楼梯或其他有高度差的地方附近使用时，应密切监控智能自动真空吸尘器的工作。请务必定期清洁跌落传感器，以确保智能自动真空吸尘器能继续正确 (请参见 '清洁智能自动真空吸尘器') 检测到高度差。

首次使用之前

安装侧毛刷

- 1 打开侧毛刷包装，将智能自动真空吸尘器正面朝下置于桌子或地板上。
- 2 将侧毛刷推入智能自动真空吸尘器 (图 8) 底部的轴上。

注意：确保您已正确安装侧毛刷。将侧毛刷按在轴上，直至您听到其咔哒一声锁定位。

将电池装入遥控器

遥控器由两节 AA 电池供电。

- 1 按释放按钮 (1) 打开电池舱盖 (2)，并卸下电池仓盖 (图 9)。
- 2 插入两节 AA 电池 (图 10)。

注意：确保电池的正负极没有装反。

- 3 要重新安装电池仓盖，请先将凸缘插入仓盖边缘 (1) 中的开口，然后向下推仓盖 (2)，直至锁定到位并发出“咔哒”一声 (图 11)。遥控器就可以使用了。

使用准备

安装底座

- 1 将适配器的小插头插入底座上的插座 (1)，将适配器插入电源插座 (2) (图 12)。
- 2 将底座放在靠墙的水平地板上。

注意：确保底座 (图 13) 正面 150 厘米、右侧 30 厘米、左侧 100 厘米没有障碍物或高度差。

充电

- 1 将智能自动真空吸尘器置于接通电源的底座 (图 14) 上。
- 2 启动/停止按钮开始闪烁 (图 16)。
- 3 当充电电池充满电时，启动/停止按钮将持续亮起 (图 17)。

准备房间以进行清洁操作

- 在启动智能自动真空吸尘器进行清洁操作之前，确保清除地板上的 (图 18) 所有散乱和易碎物体。
- 移除地板上的所有电缆、电线和绳索，以防止智能自动真空吸尘器被缠绕在其中。
- 如果您要使用智能自动真空吸尘器清洁的房间里铺有带流苏的地毯，请将流苏折叠到地毯下方，以防止智能自动真空吸尘器被流苏卡住，或损坏 (图 19) 地毯。

使用扫地机器人

启动和停止

- 1 按遥控器 (图 20) 上的启动/停止按钮。
- 2 智能自动真空吸尘器上的启动/停止按钮持续亮起，吸尘器开始清洁 (图 21)。
- 3 智能自动真空吸尘器会以自动清洁模式进行清洁，直至电池电量不足。在自动清洁模式下，智能自动真空吸尘器会重复按照随机、沿墙和螺旋移动的顺序进行清洁。
- 4 如果电池电量不足，启动/停止按钮将开始快速闪烁，智能自动真空吸尘器会开始搜索底座进行充电 (图 22)。
- 5 您也可以按启动/停止按钮中断或停止清洁操作。如果再次按启动/停止按钮且充电电池仍有足够的电量，则智能自动真空吸尘器将继续以自动清洁模式进行清洁。
- 6 要使智能自动真空吸尘器在充电电池电量不足前返回到底座，请按遥控器 (图 23) 上的插接按钮。
- 7 启动/停止按钮开始闪烁，同时智能自动真空吸尘器会返回到底座。

清洁模式选择

此智能自动真空吸尘器提供三种单独清洁模式，每种模式均可通过按遥控器上的相应按钮激活。

随机模式

在该模式下，智能自动真空吸尘器将使用直线运动和交叉运动 (图 24) 的混合模式清洁房间。

沿墙模式

在该模式下，智能自动真空吸尘器将沿着房间的墙壁对墙边区域进行特别清洁 (图 25)。

局部清洁模式

在该模式下，智能自动真空吸尘器将按照从一个中心点向外延伸螺旋移动，以彻底 (图 26) 清洁区域。

注意： 手动选定的模式仅处于启用状态数分钟。之后，智能自动真空吸尘器会切换到自动清洁模式。

手动驱动

您可以使用遥控器上的按钮手动驱动智能自动真空吸尘器。

- 1 使用遥控器启动/停止按钮的上、下、左、右箭头按钮在房间 (图 27) 内对吸尘器进行导航。

注意： 当您手动驱动吸尘器靠近有高度差的地方和楼梯时，请小心谨慎。

使用 24 小时调度器

您可以使用遥控器激活 24 小时调度器。请确保智能自动真空吸尘器处于待机模式，并且未置于底座之上。

- 1 按遥控器上的 24 小时调度器按钮 (图 28)，激活 24 小时调度器。
 - 激活 24 小时调度器后，您将听到声音并且显示屏会开始每隔几秒短暂闪烁一次。
 - 在激活 24 小时调度器的 24 小时后，智能自动真空吸尘器会开始清洁操作。它会每隔 24 小时在同一时间开始清洁操作，直至您禁用 24 小时调度器。
- 2 如需禁用 24 小时调度器，请按 24 小时调度器按钮。您将听到声音并且显示屏会持续亮起，表示智能自动真空吸尘器已处于待机模式，而 24 小时调度器也不再处于激活状态。

使用智能自动真空吸尘器拖地

FC8796 和 FC8794 类型都附带一个拖地附件和一块清洁布，用于对硬地板进行湿拖清洁。

安装清洁布

- 1 将清洁布浸泡在水中，或在水龙头下打湿。您可以滴上几滴适合您地板的现成的地板清洁剂。
- 2 彻底挤干清洁布的水，确保只潮不湿。
- 3 将潮而不湿的清洁布安装到拖地附件，方法是将清洁布的维可牢紧固件推动到拖地附件 (图 29) 的维可牢紧固件上。
- 4 将拖地附件的附件凸缘插入正好位于滚轮后面的两个附件孔中。然后向下按直到您听到“咔哒”一声 (图 30)。

使用拖地附件清洁地板

注意： 要使用拖地附件清洁硬地板，您必须从要清洁的房间中的某个位置启动智能自动真空吸尘器，而不能从安装有清洁布的底座来启动吸尘器。

- 1 只需按遥控器上的启动/停止按钮，即可启动智能自动真空吸尘器。
 - 智能自动真空吸尘器会一直拖地，直至电池电量不足才会停止工作。

注意： 在使用遥控器上的插接按钮将智能自动真空吸尘器引导至底座前，或在您手动将吸尘器置于底座前，请卸下清洁布和拖地附件。

卸下拖地附件

- 1 要卸下拖地附件，请按释放钮 (1)，并向上提拖地附件 (2) 以将其卸除 (图 31)。
- 2 将清洁布从拖地附件中抽出。
- 3 要清洗清洁布，请将其放入洗衣机中使用轻柔模式和最高 60° C 的水温清洗。

警报信号

如果智能自动真空吸尘器在清洁过程中出现故障（例如，由于滚轮阻塞或不再与地板接触，或者由于传感器无法再检测到地板），您将会听到声音，吸尘器将会停止工作。按启动/停止按钮将智能自动真空吸尘器切换到待机模式，然后解决导致发出警报信号的问题，例如采用移除阻塞滚轮的障碍物，清洁传感器，或提起智能自动真空吸尘器将其放在其他位置等方法。

清洁和保养

倒空并清洁集尘盒

集尘桶已满时，倒空并清洁集尘桶。

- 1 向上拉集尘桶盖手柄，从集尘桶仓 (图 32) 中提出集尘桶。
- 2 抽出集尘桶侧面的卡舍，以打开盖子 (图 33)。
- 3 从集尘桶 (图 34) 中取出滤网部件。
- 4 在垃圾箱上晃动集尘桶将其倒空 (图 35)。
- 5 您可以在微温水龙头下清洗集尘桶。

警告：切勿在洗碗机中清洗集尘桶。

- 6 要彻底清洁滤网，请分离滤网部件，方法是按滤网部件两侧的卡舍，并从 EPA 过滤网中取出灰尘滤网。然后，使用随附的清洁刷 (图 36) 清洁 EPA 过滤网。
- 7 重新组装滤网部件，并将 EPA 过滤网卡入灰尘滤网。然后，将滤网部件重新装入集尘桶 (图 37)。

注意：如果您在水龙头下清洗了集尘桶，请确保在重新插入滤网部件前，集尘桶是干燥的。

- 8 将盖子放在集尘桶上，并确保盖子锁定到位并听到“咔哒”一声 (图 38)。
- 9 将集尘桶放回集尘桶仓，并折叠集尘桶手柄 (图 39)。

警告：务必确保集尘桶内已放置好滤网部件。如果您在集尘桶内未放置滤网部件的情况下使用智能自动真空吸尘器，则马达将会受损。

清洁智能自动真空吸尘器

为保持良好的清洁效果，您必须经常清洁跌落传感器、滚轮、侧毛刷和吸口。

- 1 将吸尘器倒置在平面上。
- 2 要清洁侧毛刷，请抓住刷毛并将其从轴 (图 40) 上取下。
- 3 使用随附的 (图 41) 清洁刷来清洁侧毛刷及侧毛刷轴。
- 4 使用随附的 (图 42) 清洁刷来清除前轮和侧轮的灰尘或绒毛。
- 5 使用随附的 (图 43) 清洁刷来清除跌落传感器上的灰尘或绒毛。

注意：务必定期清洁跌落传感器。如果跌落传感器变脏，吸尘器可能无法检测到高度差或楼梯。

- 6 使用随附的清洁刷来清洁吸口 (图 44)。
- 7 检查吸尘器的侧毛刷和底部是否存在可能会损坏地板的尖锐物体。

更换

订购配件

要购买附件或备件，请访问 www.shop.philips.com/service 或联系您的飞利浦经销商。您还可以联系所在国家/地区的飞利浦客户服务中心（请参阅全球保修卡了解详细联系信息）。

更换滤网

如果 EPA 过滤网很脏或损坏 (请参见 '倒空并清洁集尘盒'), 请进行更换。要获得新的 EPA 过滤网, 请访问 www.philips.com/support。

更换侧毛刷

一段时间后, 请更换侧毛刷, 以确保正常的清洁效果。

注意: 发现磨损或损坏迹象时务必更换侧毛刷。另外, 建议您同时更换两个侧毛刷。要获得新的侧毛刷, 请访问 www.philips.com/support。

- 1 如需更换侧毛刷, 请抓住旧侧毛刷的刷毛将其从轴上拆下。
- 2 将新侧毛刷推到轴上。

更换充电电池

只有具备资格的服务工程师, 才能更换扫地机器人的充电电池。当充电电池无法继续充电或耗电很快时, 请将扫地机器人送往授权的飞利浦服务中心, 以更换电池。您可以在国际保修卡上找到您所在国家/地区的飞利浦客户服务中心的详细联系信息。

更换遥控器的电池

- 1 按释放钮 (1) 打开电池舱盖 (2), 并卸下电池仓盖 (图 9)。
- 2 从电池仓中取出电量耗尽的 AAA 电池。
- 3 插入两节新的 AAA 电池 (图 10)。

注意: 确保电池的正负极没有装反。

- 4 要重新安装电池仓盖, 请先将凸缘插入仓盖边缘 (1) 中的开口, 然后向下推仓盖 (2), 直至锁定到位并发出“咔哒”一声 (图 11)。遥控器就可以使用了。

注意: 根据您所在国家/地区的当地规章制度弃置电量耗尽的一次性电池。

拆下充电电池

警告: 必须在丢弃产品前取出充电电池。在取出电池时请确保电池电量已耗尽并与电源断开连接。

按照以下步骤拆下充电电池。您也可以将智能自动真空吸尘器送往飞利浦服务中心, 由其拆下充电电池。您可联系所在国家/地区的飞利浦客户服务中心, 获取您附近的服务中心地址。

- 1 让吸尘器运转, 直至充电电池电量完全耗尽, 以确保在您取出并弃置充电电池前, 其已完全放电。
- 2 拧下电池仓盖的螺丝, 然后取下仓盖 (图 45)。
- 3 取出充电电池并断开连接 (图 46)。
- 4 将智能自动真空吸尘器和充电电池送往电子电器垃圾回收点。

故障种类和处理方法

本章归纳了使用本产品时最常见的一些问题。如果您无法根据以下信息解决问题, 请访问 www.philips.com/support 查阅常见问题列表, 或联系您所在国家/地区的客户服务中心。

问题	可能的原因	解决方法
按启动/停止按钮时智能自动真空吸尘器无法开始清洁。	充电电池的电量已耗尽。	为充电电池 (请参见 '使用准备') 充电。
随意按下一个按钮时, 智能自动真空吸尘器没有反应。	智能自动真空吸尘器无法找到底座, 而且电池电量已经耗尽。	将智能自动真空吸尘器置于接通电源的底座上。几秒钟后, 智能自动真空吸尘器发出“哔”声, 显示器亮起。
智能自动真空吸尘器发出“哔”声后停止工作。	一个或多个滚轮被卡住。	按启动/停止按钮。清除滚轮悬架周围吸附的绒毛、毛发、线头或线丝。
	一个或两个侧毛刷被卡住。	清洁侧毛刷 (请参见 '清洁智能自动真空吸尘器')。
	清洁时智能自动真空吸尘器被提起。	按启动/停止按钮。将智能自动真空吸尘器置于地板上。然后按启动/停止按钮使智能自动真空吸尘器继续清洁。
智能自动真空吸尘器无法正确清洁。	一个或两个侧毛刷的刷毛已变形或弯曲。	将毛刷在温水中浸泡一会儿。如果这样做不能使刷毛复原, 则更换侧毛刷 (请参见 '更换侧毛刷')。
	集尘盒中的滤网变脏。	拆卸滤网部件。使用软毛牙刷清洁灰尘滤网和 EPA 过滤网。您还可以在水龙头下冲洗灰尘滤网。 如果清洁 EPA 过滤网不再有用, 请使用新过滤网更换。我们建议您至少每年更换一次 EPA 过滤网。
	集尘盒底部吸口被堵塞。	清洁吸口 (请参见 '清洁智能自动真空吸尘器')。
	前轮被毛发或其他污垢卡住。	清洁前轮 (请参见 '清洁智能自动真空吸尘器')。
	智能自动真空吸尘器在清洁颜色极深或有光泽的地面时会触发跌落传感器。这将导致智能自动真空吸尘器沿异常的方向图移动。	按启动/关闭按钮, 然后将智能自动真空吸尘器移至颜色较浅的地板。如果在颜色较浅的地板上问题仍然存在, 请访问 www.philips.com/support 或联系您所在国家/地区的客户服务中心。
	智能自动真空吸尘器正在清洁强烈反射太阳光的地板。这可能会触发跌落传感器, 导致智能自动真空吸尘器沿异常的方向图移动。	关闭窗帘, 阻止太阳光射入房间。您还可以在阳光不那么明亮时开始清洁。
充电电池无法充电或耗电极快。	充电电池达到了其寿命的终点。	充电电池应由飞利浦服务中心 (请参见 '更换充电电池') 更换。

问题	可能的原因	解决方法
智能自动真空吸尘器在绕圈运动。	智能自动真空吸尘器处于局部清洁模式。	这属于正常现象。彻底清洁过程中在地板上检测到大量灰尘时，可能激活局部清洁模式。这也是自动清洁模式的一部分。大约一分钟后，智能自动真空吸尘器恢复正常清洁模式。您还可以通过在遥控器上选择不同的清洁模式来停止局部清洁模式。 您还可以通过在遥控器上选择不同的清洁模式来停止局部清洁模式。
智能自动真空吸尘器无法找到底座。	没有足够的空间供智能自动真空吸尘器导航到底座。 智能自动真空吸尘器仍在积极搜索。	请尝试将底座 (请参见 '安装底座') 放置到其他地方。 给智能自动真空吸尘器约 20 分钟时间让其返回到底座。

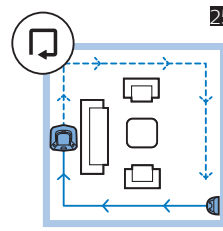
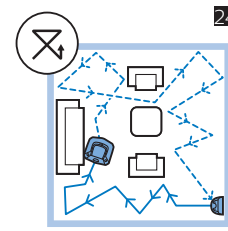
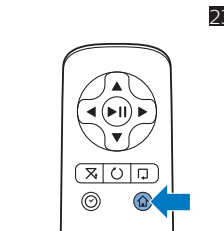
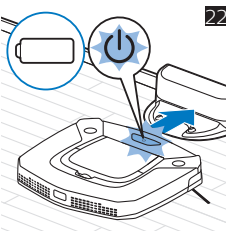
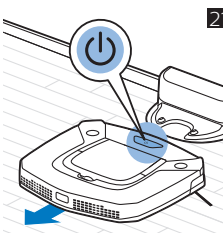
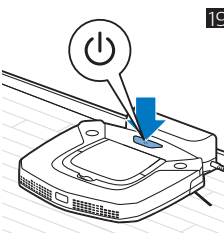
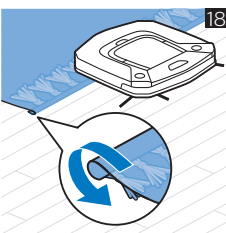
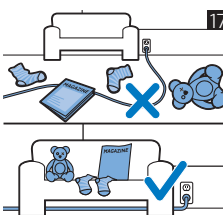
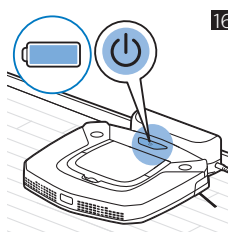
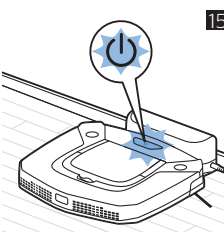
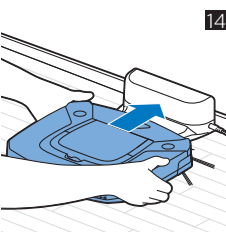
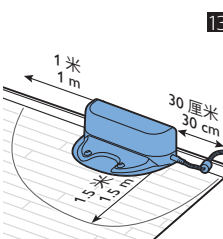
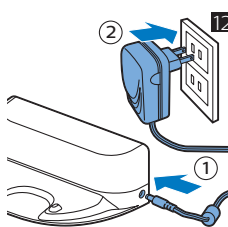
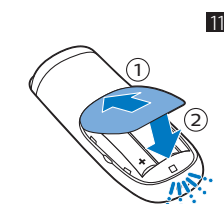
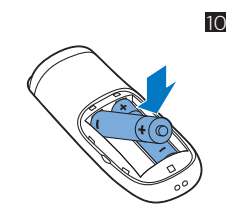
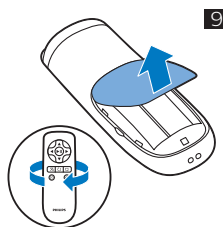
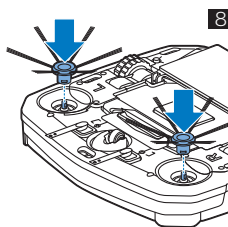
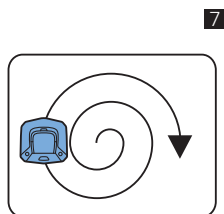
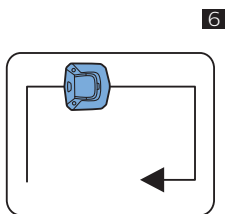
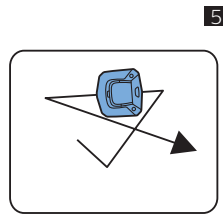
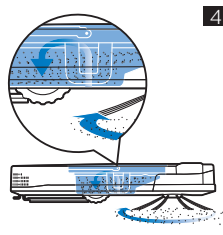
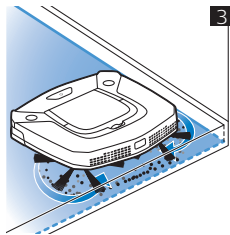
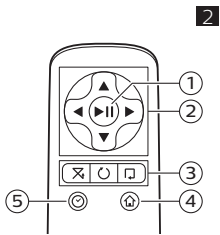

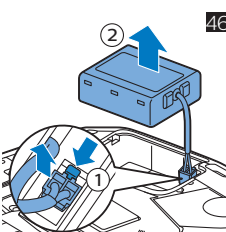
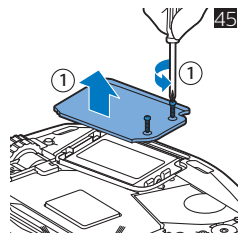
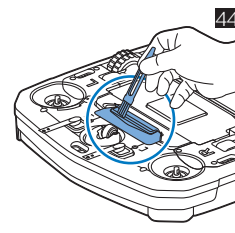
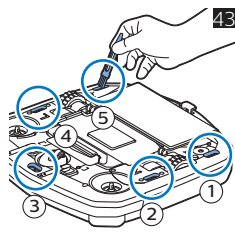
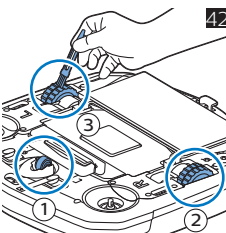
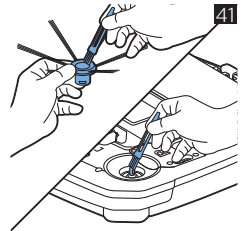
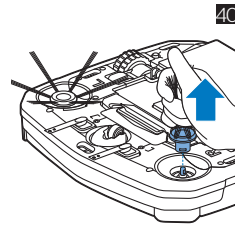
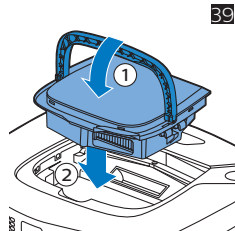
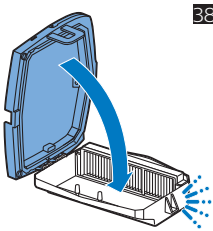
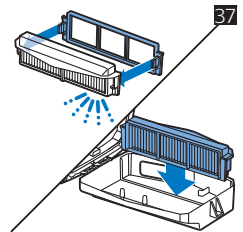
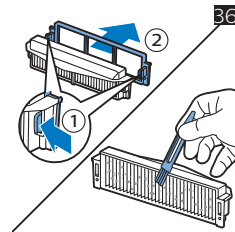
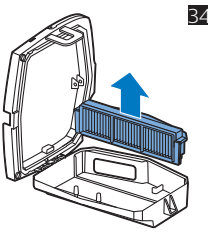
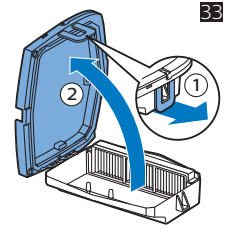
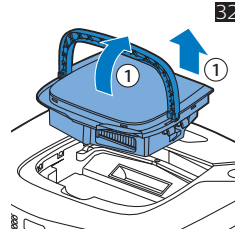
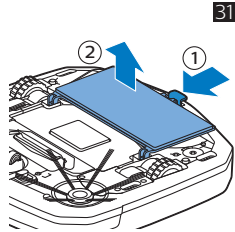
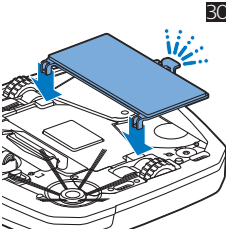
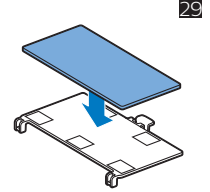
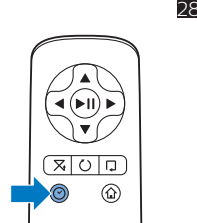
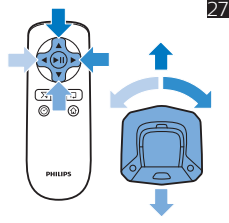
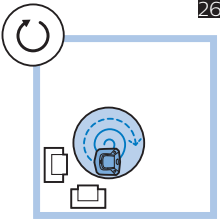

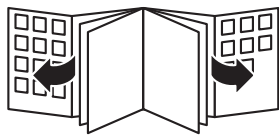



4222.003.4295.3 8/1/2018
> 75% 循环再造纸

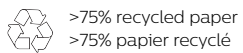

>75% recycled paper
>75% papier recyclé