

Moltio

USER MANUAL

Type HD8769, HD8777, HD8778, HD8869, HD8886

Read carefully before using the machine.



EN

02



Register your product and get support at
www.saeco.com/welcome

IMPORTANT SAFEGUARDS

When using electrical appliances, basic safety precautions should always be followed, including the following:

1. Read all instructions.
2. Do not touch hot surfaces. Use handles or knobs.
3. To protect against fire, electric shock and injury to persons do not immerse cord, plugs, or appliance in water or other liquid.
4. Close supervision is necessary when the appliance is used by or near children.
5. Unplug from outlet when not in use and before cleaning. Allow to cool before putting on or taking off parts, and before cleaning the appliance.
6. Do not operate any appliance with a damaged cord or plug or after the appliance malfunctions, or has been damaged in any manner. Return appliance to the nearest authorized service facility for examination, repair or adjustment.
7. The use of accessory attachments not recommended by the appliance manufacturer may result in fire, electric shock or injury to persons.
8. Do not use outdoors.
9. Do not let cord hang over edge of table or counter, or touch hot surfaces.
10. Do not place on or near a hot gas or electric burner, or in a heated oven.
11. Always attach plug to appliance first, then plug cord into wall outlet. To disconnect, turn any control to "off", then remove plug from wall outlet.
12. Do not use appliance for other than intended use.
13. Save these instructions.

SAVE THESE INSTRUCTIONS

CAUTION

This appliance is for household use only. Any servicing, other than cleaning and user maintenance, should be performed by an authorized service center. Do not immerse machine in water. To reduce the risk of fire or electric shock, do not disassemble the machine. There are no parts inside the machine serviceable by the user. Repair should be done by authorized service personnel only.

1. Check voltage to be sure that the voltage indicated on the nameplate corresponds with your voltage.
2. Never use warm or hot water to fill the water tank. Use cold water only.
3. Keep your hands and the cord away from hot parts of the appliance during operation.
4. Never clean with scrubbing powders or harsh cleaners. Simply use a soft cloth dampened with water.
5. For optimal taste of your coffee, use purified or bottled water. Periodic descaling is still recommended every 2-3 months.
6. Do not use caramelized or flavored coffee beans.

INSTRUCTIONS FOR THE POWER SUPPLY CORD

- A. A short power-supply cord (or detachable power-supply cord) is to be provided to reduce risks resulting from becoming entangled in or tripping over a longer cord.
- B. Longer detachable power-supply cords or extension cords are available and may be used if care is exercised in their use.
- C. If a long detachable power-supply cord or extension cord is used,
 1. The marked electrical rating of the detachable power-supply cord or extension cord should be at least as great as the electrical rating of the appliance
 2. If the appliance is of the grounded type, the extension cord should be a grounding-type 3-wire cord, and
 3. The longer cord should be arranged so that it will not drape over the counter top or table top where it can be pulled on by children or tripped over.

*Congratulations on your purchase of a Saeco Moltio One Touch Milk Carafe fully automatic coffee machine!
To fully benefit from the support that Saeco offers, please register your product at www.saeco.com/welcome.
The machine is suitable for preparing espresso coffee using whole coffee beans, and it is supplied with a milk carafe to prepare a perfect Cappuccino or Latte Macchiato in a quick and easy way. In this user manual you will find all the information you need to install, use, clean and descale your machine.*

CONTENTS

IMPORTANT	4
Safety Instructions.....	4
Warnings.....	4
Cautions.....	6
Compliance with Standards.....	7
INSTALLATION	8
Product Overview.....	8
General Description.....	9
PREPARING FOR USE	10
Machine Packaging.....	10
Machine Installation.....	10
USING THE MACHINE FOR THE FIRST TIME	13
Circuit Priming.....	13
Automatic Rinse/Cleaning Cycle.....	15
Manual Rinse Cycle.....	15
Measuring and Programming Water Hardness.....	19
"INTENZA+" Water Filter Installation.....	20
Replacing the "INTENZA+" Water Filter.....	22
CHANGING COFFEE BEANS	23
Removing the Coffee Bean Hopper.....	23
Inserting the Coffee Bean Hopper.....	24
Selecting Coffee Beans.....	26
Coffee Emptying Cycle.....	27
ADJUSTMENTS	28
Saeco Adapting System.....	28
Adjusting the Ceramic Coffee Grinder.....	28
Adjusting the Aroma (Coffee Strength).....	29
Adjusting the Coffee Dispensing Spout.....	30
Adjusting the Coffee Length.....	31
BREWING ESPRESSO AND COFFEE	32
Brewing Espresso and Coffee Using Coffee Beans.....	32
Brewing Espresso and Coffee Using Pre-Ground Coffee.....	33

MILK CARAFE	34
Filling the Milk Carafe	34
Inserting the Milk Carafe	35
Removing the Milk Carafe	35
Emptying the Milk Carafe.....	36
BREWING A CAPPUCCINO	37
Adjusting the Cappuccino Length.....	39
LATTE MACCHIATO BREWING	41
Adjusting the Latte Macchiato length	43
FROTHING MILK	45
Adjusting the Frothed Milk Length.....	47
QUICK CARAFE RINSE CYCLE	49
DISPENSING HOT WATER	50
CLEANING AND MAINTENANCE	52
Daily Cleaning of the Machine.....	52
Daily Cleaning of the Water Tank.....	53
Daily Cleaning of the Milk Carafe.....	54
Weekly Cleaning of the Machine	56
Weekly Cleaning of the Milk Carafe	56
Weekly Cleaning of the Brew Group	61
Weekly Cleaning of the Coffee Bean Hopper, Tray and Coffee Compartment	64
Monthly Cleaning of the Milk Carafe	65
Monthly Lubrication of the Brew Group	70
Monthly Cleaning of the Brew Group with "Coffee Oil Remover"	71
DESCALING	74
ACCIDENTAL INTERRUPTION OF THE DESCALING CYCLE	80
PROGRAMMING	81
The following settings can be adjusted	81
How to Program the Machine	83
MEANING OF THE DISPLAY ICONS	85
TROUBLESHOOTING	90
ENERGY SAVING	94
Stand-by	94
Disposal	94
TECHNICAL SPECIFICATIONS	95
WARRANTY AND SERVICE	95
Warranty	95
Service	95
ORDERING MAINTENANCE PRODUCTS	96
MACHINE ACCESSORIES	97

IMPORTANT

Safety Instructions

This machine is equipped with safety devices. Nevertheless, read and follow the safety instructions carefully and only use the machine properly as described in these instructions to avoid accidental injury or damage due to improper use of the machine. Keep this user manual for future reference.



The term **WARNING** and this sign warn against possible severe injuries, danger to life and/or damage to the machine.



The term **CAUTION** and this sign warn against slight injuries and/or damage to the machine.

Warnings

- Connect the machine to a wall socket with a voltage matching the technical specifications of the machine.
- Connect the machine to a earthed wall socket.
- Do not let the power cord hang over the edge of a table or counter, or touch hot surfaces.
- Never immerse the machine, the mains plug or power cord in water: Danger of electrical shock!
- Do not pour liquids on the power cord connector.
- Never direct the hot water jet towards body parts: Danger of burning!
- Do not touch hot surfaces. Use handles and knobs.
- Remove the mains plug from the wall socket:
 - if a malfunction occurs;

- If the machine will not be used for a long time;
- before cleaning the machine.

Pull on the mains plug, not on the power cord. Do not touch the mains plug with wet hands.

- Do not use the machine if the mains plug, the power cord or the machine itself is damaged.
- Do not make any modifications to the machine or its power cord. Only have repairs carried out by a service centre authorised by Philips to avoid any hazard.
- The machine should not be used by children younger than 8 years old.
- The machine can be used by children of 8 years and upwards if they have previously been instructed on the correct use of the machine and made aware of the associated dangers or if they are supervised by an adult.
- Cleaning and maintenance should not be carried out by children unless they are more than 8 years old and supervised by an adult.
- Keep the machine and its power cord out of reach of children under 8 years old.
- The machine may be used by persons with reduced physical, sensory or mental capabilities or lacking sufficient experience and/or skills if they have previously been instructed on the correct use of the machine and made aware of the associated dangers or if they are supervised by an adult.
- Children should be supervised to ensure that they do not play with the machine.
- Never insert fingers or other objects into the coffee grinder.

Cautions

- The machine is for household use only. It is not intended for use in environments such as canteens, staff kitchens of shops, offices, farms or other work environments.
- Always put the machine on a flat and stable surface.
- Do not place the machine on hot surfaces, directly next to a hot oven, heater units or similar sources of heat.
- Only put roasted coffee beans into the coffee bean hopper. If ground coffee, instant coffee, raw coffee or any other substance is put in the coffee bean hopper, it may damage the machine.
- Let the machine cool down before inserting or removing any parts.
- Never use warm or hot water to fill the water tank. Use only cold non-sparkling drinking water.
- Never clean with scrubbing powders or harsh cleaners. Simply use a soft cloth dampened with water.
- Descale your machine regularly. The machine indicates when descaling is needed. Not doing this will make your appliance stop working properly. In this case repair is not covered under your warranty!
- Do not keep the machine at temperature below 0 °C. Residue water in the heating system may freeze and cause damage.
- Do not leave water in the water tank if the machine is not used over a long period of time. The water can get contaminated. Use fresh water every time you use the machine.

Compliance with Standards

The machine complies with art.13 of the Italian Legislative Decree dated 25 July 2005, no. 151 "Implementation of the Directives 2005/95/EC, 2002/96/EC and 2003/108/EC on the restriction of the use of certain hazardous substances in electrical and electronic equipment, as well as waste disposal".

This machine complies with EU Directive 2002/96/EC.

This Philips appliance complies with all the applicable standards and regulations relating to the exposure to electromagnetic fields.

INSTALLATION

Product Overview

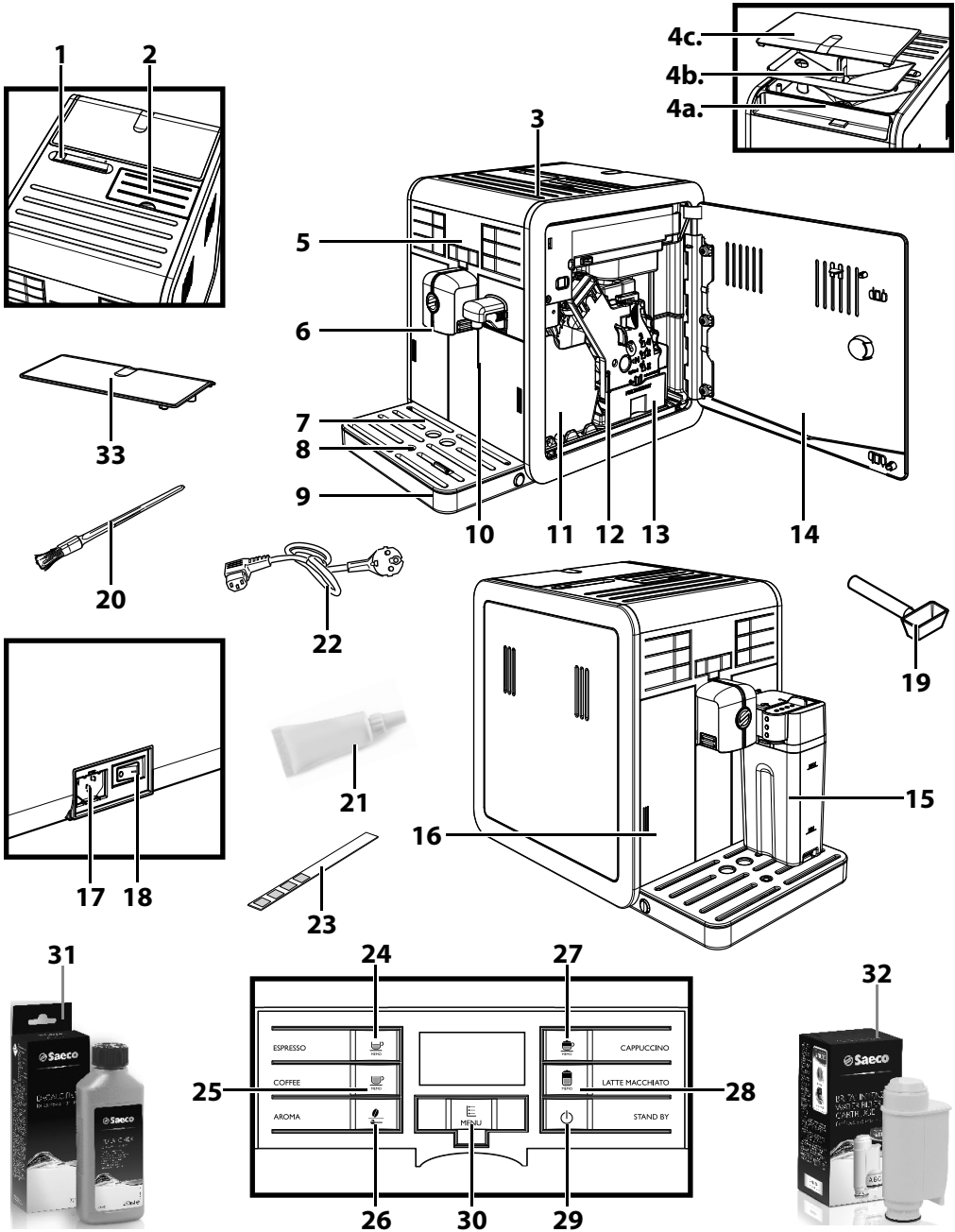

General Description

1. Coffee bean hopper locking/removal selector switch
2. Pre-ground coffee compartment
3. Cup stacking surface
- 4a. Coffee bean hopper
- 4b. Coffee bean hopper tray
- 4c. Coffee bean hopper lid
5. Control panel
6. Coffee dispensing spout
7. Cup holder grill
8. Full drip tray indicator
9. Drip tray
10. Water dispensing spout (removable)
11. Coffee grounds drawer
12. Brew group
13. Coffee residues drawer
14. Service door
15. Milk carafe
16. Water tank
17. Power cord socket
18. Power button
19. Coffee grinder adjustment key + Pre-ground coffee measuring scoop
+ Tool to clean the coffee outlet duct
20. Cleaning brush (optional)
21. Grease for brew group (optional)
22. Power cord
23. Water hardness test strip
24. Espresso brew button
25. Coffee brew button
26. "Aroma" - Pre-ground coffee button
27. Cappuccino brew button
28. Latte Macchiato brew button
29. ON/OFF button
30. "MENU" button
31. Descaling solution (to be purchased separately)
32. Filter (INTENZA+) (to be purchased separately)
33. Protection cover.

PREPARING FOR USE

Machine Packaging

The original packaging has been designed and constructed to protect the machine during transport. We recommend keeping the packaging material for possible future transport.

Machine Installation

1 Remove the drip tray with grill from the packaging.

2 Remove the machine from the packaging.

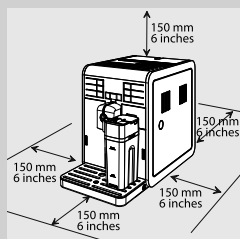

3 For best use, it is recommended to:

- Choose a safe, level surface, where there will be no danger of overturning the appliance or being injured;
- Choose a location that is sufficiently well-lit, clean and near an easily reachable socket.
- Allow for a minimum distance from the sides of the machine as shown in the figure.

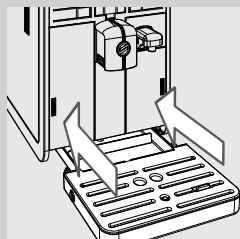

4 Insert the drip tray with grill into the machine. Make sure it is fully inserted.



Note:

The drip tray collects the water that comes out of the coffee dispensing spout during each rinse/self-cleaning cycle, as well as any coffee that might be spilled during beverage brewing. Empty and wash the drip tray daily and each time the full drip tray indicator is raised.

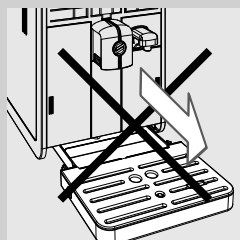

Caution:

NEVER remove the drip tray when the machine has just been turned on. Wait a couple of minutes for the machine to carry out a rinse/self-cleaning cycle.



5 Press gently on the side of the water tank door to release the handgrip.

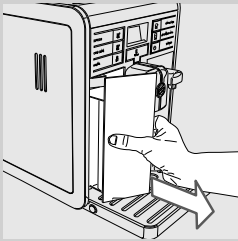

6 Remove the water tank by pulling it by the handgrip.

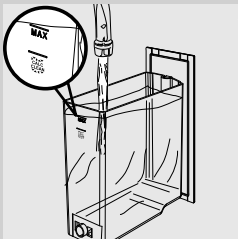

7 Rinse the water tank with fresh water.

8 Fill the water tank with fresh water up to the MAX level and reinsert it into the machine. Make sure it is fully inserted.

! **Caution:**

Never fill the water tank with warm, hot, sparkling water or any other liquid, as this may cause damage to the water tank and the machine.

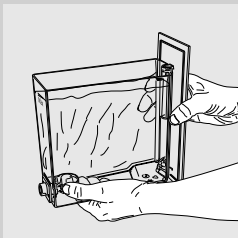

≡ **Note:**

When the water tank is full, it must be transported as shown in the figure.

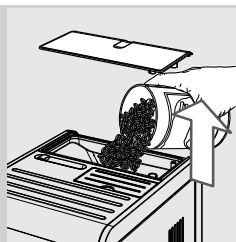

9 Remove the coffee bean hopper lid. Slowly pour in the coffee beans.

Note:

The coffee bean hopper contains a tray that vibrates during grinding and conveys the beans into the coffee grinder.

Caution:

Only coffee beans must be put into the coffee bean hopper. If ground coffee, instant coffee, caramelized coffee, raw coffee or any other substance is put into the coffee bean hopper, it may damage the machine.

10 Put the lid back on the coffee bean hopper.

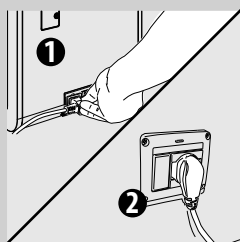

11 Insert the plug into the socket located on the back of the machine.

12 Insert the plug at the other end of the power cord into a wall socket with suitable power voltage.

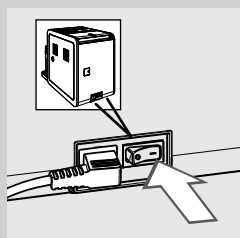

13 Switch the power button to "I" to turn on the machine. The red light next to the "I" button flashes.

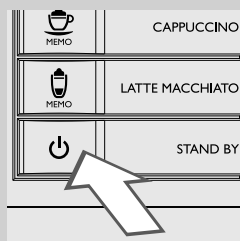

14 To turn on the machine, simply press the "I" button.

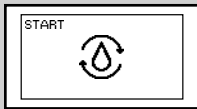
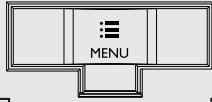

Yellow

**Note:**

By keeping the  button pressed for more than 8 seconds, the machine enters the demo mode. To exit the demo, disconnect the power cord and turn the machine back on.

15 The control panel indicates that the circuit must be primed.

USING THE MACHINE FOR THE FIRST TIME

When using the machine for the first time, the following activities need to happen:

- 1) You need to prime the circuit.
- 2) The machine will perform an automatic rinse/cleaning cycle.
- 3) You need to perform a manual rinse cycle.

Circuit Priming

During this process, fresh water flows through the internal circuit of the machine and the machine warms up. This takes a few minutes.

- 1** Place a container under the hot water dispensing spout.

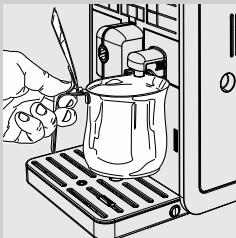

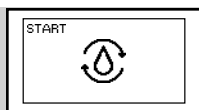

Yellow

- 2** Press the "MEMO" button to start the circuit priming cycle.



Yellow

- 3** The machine reminds you to install the water dispensing spout. Press the "MEMO" button to confirm. The machine will start dispensing hot water.



Yellow

- 4** The bar under the icon shows the operation progress. When the process has been completed, the machine stops dispensing automatically.

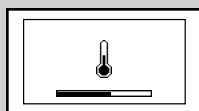

Yellow

- 5** The control panel now shows the machine warm-up icon.

Automatic Rinse/Cleaning Cycle

When warm-up has been completed, the machine automatically performs a rinse/self-cleaning cycle of the internal circuits with fresh water. This takes less than a minute.

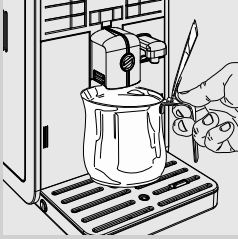

- 1 Place a container under the coffee dispensing spout to catch the small amount of water which will be dispensed.



Yellow

- 2 The machine shows this display. Wait for the cycle to finish automatically.



Note:

You can stop dispensing by pressing the "☕" button.

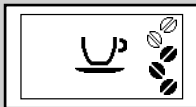

Green

- 3 When the operations described above have been completed, the machine shows this display. You can now perform the manual rinse cycle.

Manual Rinse Cycle

During this process you activate the coffee brewing cycle and fresh water flows through the water circuit. This takes a few minutes.

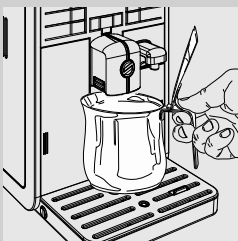

- 1 Place a container under the coffee dispensing spout.

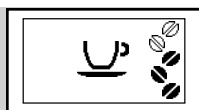

Green

2 Check that the machine shows this display.

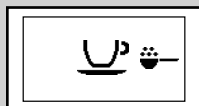

Green

3 Select the pre-ground coffee brewing function by pressing the "☕" button. The machine shows this display.



Note:

Do not add any pre-ground coffee into the compartment.

4 Press the "☕" button. The machine starts dispensing water.

5 When dispensing has finished, empty the container. Repeat the operations from step 1 to step 4 three times, then continue with step 6.

6 Place a container under the hot water dispensing spout.

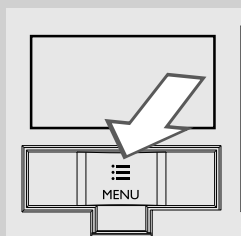

7 Press the "☰" MENU button. The machine shows this display.

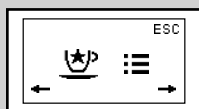

Green

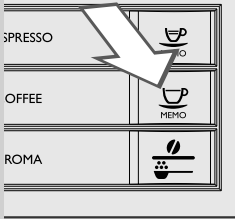

8 Press the "MEMO" button.



9 This icon is displayed.

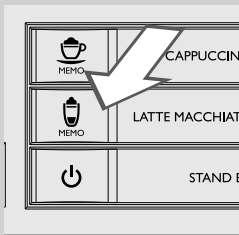

10 Press the "MEMO" button to start dispensing hot water.



11 This icon is displayed. The machine reminds you to install the water dispensing spout. Check that the water dispensing spout is correctly installed. Press "MEMO" to confirm. The machine will start dispensing hot water.

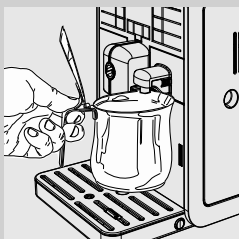

12 After dispensing water, remove and empty the container.



Note:

Press the "MEMO" button to stop the manual rinse cycle.



Red

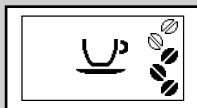
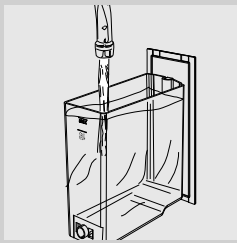

Green

13 Repeat steps 6 to 12 until the water tank is empty and the no water warning sign appears.

14 At the end of this operation, fill the water tank again up to the MAX level. Now the machine is ready to brew coffee. This icon will be displayed.



Note:

The automatic rinse/self-cleaning cycle starts when the machine has been in stand-by mode, or turned off, for more than 15 minutes.

When you have not used the machine for 2 or more weeks, you will need to perform a manual rinse cycle.

At the end of the cycle, you can brew a coffee.

Measuring and Programming Water Hardness

Water hardness measuring is very important in order to define the descaling frequency and to install the "INTENZA+" water filter (for more details on the water filter, see next chapter).

To measure the water hardness follow the steps below:

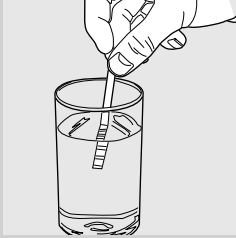

- 1** Immerse the water hardness test strip (supplied with the machine) in water for 1 second.



Note:

The test strip can only be used for one single measurement.

- 2** Wait for one minute.

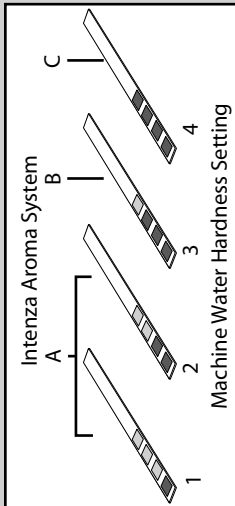

- 3** Check how many squares have changed to red, then consult the table.



Note:

The numbers on the water hardness test strip correspond to the water hardness adjustment settings.

More precisely:

- 1 = 1 (very soft water)
- 2 = 2 (soft water)
- 3 = 3 (hard water)
- 4 = 4 (very hard water)

The letters correspond to the references that are located at the base of the "INTENZA+" water filter (see next chapter).

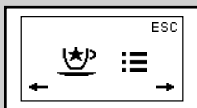

Green

- 4** Press the "MENU" button. The machine shows this icon.

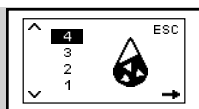

Yellow

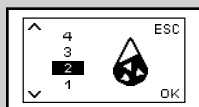

Yellow

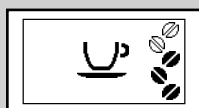

Green

- 5** Press the “MEMO” button to access the programming menu. Press the “MEMO” button to scroll the functions until this icon appears.

Note:

The machine is supplied with a standard water hardness setting, suitable for most types of water.

- 6** Press the “MEMO” button to increase the value and the “MEMO” button to decrease the value.

- 7** Press the “MEMO” button to confirm the setting.

- 8** Press the “MEMO” button twice to exit the programming menu. Now the machine is ready for brewing.

“INTENZA+” Water Filter Installation

We recommend you to install the “INTENZA+” water filter as this prevents limescale build-up in your machine and preserves a more intense aroma of your coffee.

The “INTENZA+” water filter can be purchased separately. For further details, please refer to the maintenance products page in this user manual. Water is a crucial part of every coffee, so it is very important to always have it professionally filtered. Using the “INTENZA+” water filter will prevent mineral deposits from building up and improve your water quality.

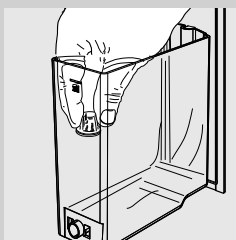

- 1** Remove the small white filter from the water tank and store it in a dry place.



- 2** Remove the "INTENZA+" water filter from its packaging, immerse it vertically (with the opening positioned upwards) in cold water and gently press the sides so as to let the air bubbles out.

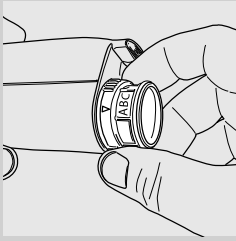

- 3** Set the "INTENZA+" water filter according to the measurements performed (see previous chapter) and indicated on the base of the filter:
 A = soft water – equals 1 or 2 on the test strip
 B = hard water (standard) – equals 3 on the test strip
 C = very hard water – equals 4 on the test strip



- 4** Put the "INTENZA+" water filter into the empty water tank. Press it down until it cannot move any further.

- 5** Fill the water tank with fresh water and put it into the machine.

- 6** Dispense all the water in the tank by using the hot water function (see the "Dispensing Hot Water" section).

- 7** Fill the water tank again.

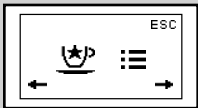

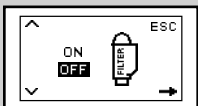

Green

- 8** Press the  **MENU** button. The machine shows this icon.



Yellow

- 9** Press the  button to access the programming menu. Press the  button to scroll the functions until this icon appears.

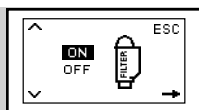

Yellow

10 Press the “☕”
MEMO button to select “ON” and press the “☕”
MEMO button to confirm.

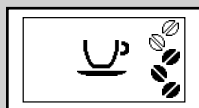

Green

11 To exit, press the “☕”
MEMO button twice. Now the machine is ready for brewing.

In this way the machine has been programmed to inform the user of the need to replace the “INTENZA+” water filter.

Replacing the “INTENZA+” Water Filter

When the “INTENZA+” water filter needs to be replaced with a new one, this icon is displayed.



Yellow

1 Replace the “INTENZA+” water filter as described in the previous chapter.

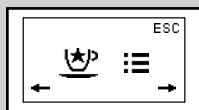

Green

2 Press the “☰” **MENU** button. The machine shows this icon.

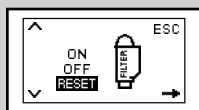

Yellow

3 Press the “☕”
MEMO button to access the programming menu. Press the “☕”
MEMO button to scroll the functions until this icon appears.

4 Select the “RESET” option. Press the “☕”
MEMO button to confirm.



Green

- 5** To exit, press the “MEMO” button twice. Now the machine is ready for brewing.

The machine is now programmed to manage a new filter.



Yellow

Note:

If the “INTENZA+” water filter is already installed and you want to remove, but not replace it, select the “OFF” option instead.

If there is no “INTENZA+” water filter installed, insert the small white filter previously removed into the water tank.

CHANGING COFFEE BEANS

The machine comes with a removable coffee bean hopper so you can easily switch from one type of coffee bean to another and enjoy a different coffee taste.

Note:

You can buy an additional coffee bean hopper as an accessory (CA6803). To preserve their taste, you can store coffee beans in the bean hopper in the refrigerator.

Removing the Coffee Bean Hopper

To remove the coffee bean hopper follow the steps below:

- 1** Move the selector switch to the “1” position.

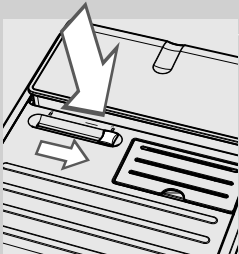

! Caution:

It may happen that the selector switch can not be shifted as it is blocked by coffee beans. In this case, move the selector switch back and forth until the coffee beans are released.

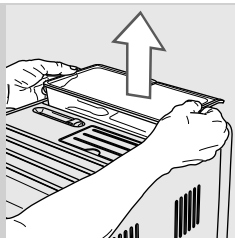

2 Lift the sides of the coffee bean hopper with both hands as shown in the figure.



Caution:

Do not remove the coffee bean hopper in a different way to avoid spilling coffee beans.

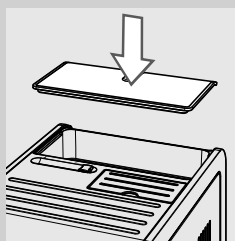

3 After removing it, put the protection lid on the machine to keep it dust-free.

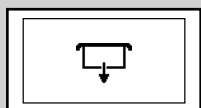

Red



Note:

If the machine is turned on without the coffee bean hopper being inserted, this icon will appear. You need to insert the coffee bean hopper first.

Inserting the Coffee Bean Hopper

To insert the coffee bean hopper, follow the steps below:

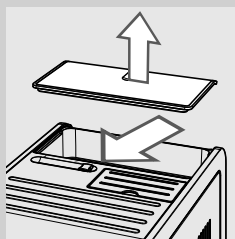

1 Remove the protection cover from the machine.

2 Move the selector switch to the “☐” position.

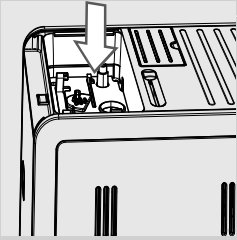

3 Remove any beans from the coffee bean hopper compartment.

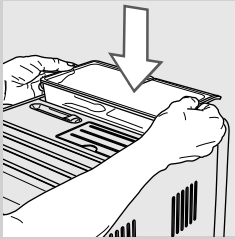

4 Insert the coffee bean hopper into its compartment as shown in the figure.

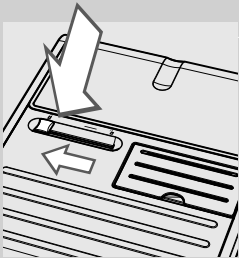

5 Move the selector switch to the "D" position.



Warning:

Please be aware that when you change coffee beans and switch to decaffeinated coffee, some caffeine traces might still be present even after performing an emptying cycle.

Selecting Coffee Beans

This function allows you to optimize grinding according to the selected type of coffee beans.

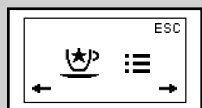

Green

- 1 Press the "MENU" button. The machine shows this icon.



Yellow

- 2 Press the "MEMO" button to access the programming menu. Press the "MEMO" button to scroll the functions until this icon appears.

- 3 Press the "MEMO" button or the "MEMO" button to select the type of coffee beans in the coffee bean hopper.

- 4 Press the "MEMO" button to confirm the setting.

- 5 To exit, press the "MEMO" button twice.

The machine is now programmed to optimise coffee bean grinding.

The display shows the selected type of coffee beans when the machine is ready for brewing.

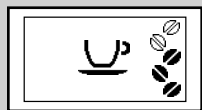

Green

- for "ARABICA" coffee beans;



Green

- for "ROBUSTA" coffee beans;



Green

- for "MIXED" coffee beans.

Coffee Emptying Cycle

When you change coffee beans, it is recommended to empty the coffee outlet duct and grinder. In this way, you will be able to fully taste the new coffee beans aroma. For this, follow the steps below:

1 Fill the coffee bean hopper with coffee beans.

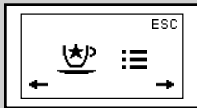

Green

2 Press the "☰" **MENU** button. The machine shows this icon.

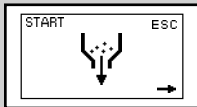

Yellow

3 Press the "☰" button to access the programming menu. Press the "☰" button to scroll the functions until this icon appears.

4 Press the "☺" button.

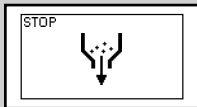

Yellow

5 The machine performs two grinding cycles without brewing coffee.

Note:

If you press the "☺" button between the first and second grinding cycle, you can stop the grinding cycle earlier.

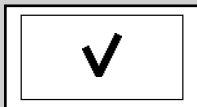

Green

6 When the grinding cycles have been completed, the machine shows this icon.

Note:

If you have not emptied the coffee duct and grinder, you need to brew at least two coffees before you can taste the new coffee beans.

Warning:

Please be aware that when you change coffee beans and switch to decaffeinated coffee, some caffeine traces might still be present even after performing an emptying cycle.

ADJUSTMENTS

The machine allows for certain adjustments so that you can brew the best tasting coffee possible.

Saeco Adapting System

Coffee is a natural product and its characteristics may change according to its origin, blend and roast. The machine is equipped with a self-adjusting system that allows the use of all types of coffee beans available on the market, except for raw, caramelized and flavoured coffee beans.

The machine automatically adjusts itself after brewing several cups of coffee to optimize coffee extraction.

Adjusting the Ceramic Coffee Grinder

Ceramic coffee grinders always guarantee accurate and perfect grinding and coarseness for every coffee speciality. This provides full aroma preservation, delivering a truly Italian taste in every cup.



Warning:

The ceramic coffee grinder contains moving parts that may be dangerous. Do not insert fingers or other objects. Only adjust the ceramic coffee grinder using the grinder adjustment key.

You can adjust the ceramic grinders to set the coffee grinding to your personal taste.

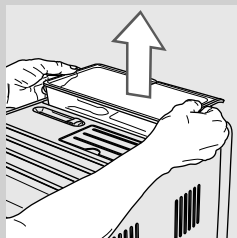

- 1 Remove the coffee bean hopper as shown in the "Removing the Coffee Bean Hopper" section.

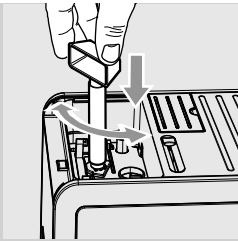

2 Press and turn the grinder adjustment knob under the coffee bean hopper one notch at a time. Use the coffee grinder adjustment key provided with the machine. You will taste the difference after brewing 2-3 cups of coffee.



Warning:

Do not turn the coffee grinder more than one notch at a time to prevent damage.

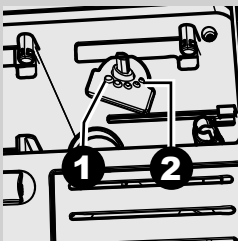

3 The reference marks in the coffee bean hopper compartment indicate the grind setting. There are 5 different grind settings to choose from, from position 1 for coarse grind - lighter taste to position 2 for fine grind - stronger taste. If coffee is watery or is brewed slowly, change the coffee grinder settings.

Adjusting the Aroma (Coffee Strength)

Choose your favourite coffee blend and adjust the amount of coffee to be ground according to your personal taste. You can also select the pre-ground coffee function.



Note:

Selection must be made prior to selecting coffee.

You can choose from 5 options by pressing the "☕" button. Each time the "☕" button is pressed, the aroma changes by one degree according to the selected amount:

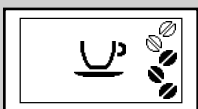

Green

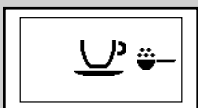

Green

- ☕☕☕☕☕ = extra mild aroma
- ☕☕☕☕☕ = mild aroma
- ☕☕☕☕☕ = medium aroma
- ☕☕☕☕☕ = strong aroma
- ☕☕☕☕☕ = extra strong aroma
- ☕☕☕☕☕ = pre-ground coffee

Adjusting the Coffee Dispensing Spout

The height of the coffee dispensing spout can be adjusted to better fit the dimensions of the cups that you wish to use.

Move the coffee dispensing spout up or down with your fingers to adjust its height as shown in the figure.

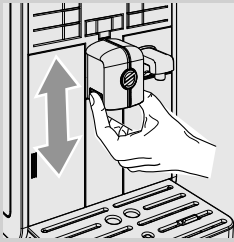

The recommended positions are:
For the use of small cups.

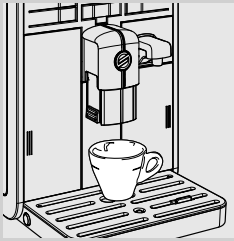

For the use of large cups.



For the use of glasses for the Latte Macchiato.

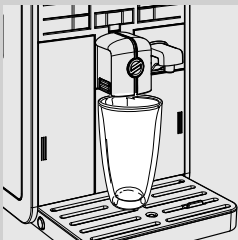

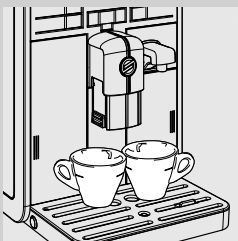

Two cups can be placed under the coffee dispensing spout to brew two coffees at the same time.



Adjusting the Coffee Length

The machine allows you to adjust the amount of brewed coffee according to your taste and/or the size of your cups.

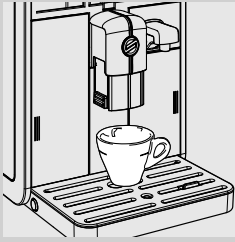

Each time the “” or “” button is pressed, the machine brews a pre-set amount of coffee. Each button may be individually programmed for a specific brew setting.



- 1 Place a cup under the coffee dispensing spout.



Green

- 2 Keep the “” button pressed until the “**MEMO**” icon appears on the display to program an espresso, or do the same with the “” button to program a coffee. Then release the button. The machine is in programming mode and starts brewing the selected product.



Green

- 3 Press the “” button as soon as the desired amount of espresso or coffee is reached.

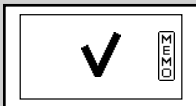

Green

The previously selected “” or “” button is now programmed; each time it is pressed, the machine will brew the same amount of espresso or coffee that was just programmed.

BREWING ESPRESSO AND COFFEE

Before brewing coffee, make sure that there are no warnings shown on the control panel, and that the water tank and coffee bean hopper are filled.

Brewing Espresso and Coffee Using Coffee Beans

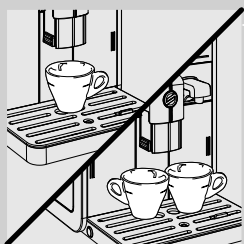

1 Place 1 or 2 cups under the coffee dispensing spout.

2 To brew an espresso or a coffee, press the “☕” button to select the desired aroma.



Green

3 Press the “☕_{MEMO}” button for an espresso or the “☕_{MEMO}” button for a coffee.

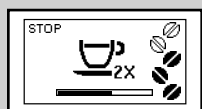

Green

4 To brew 2 cups of espresso or coffee, press the desired button twice consecutively. This icon will be displayed.

Note:

In this operating mode, the machine automatically grinds and doses the correct amount of coffee. Brewing two espressos or two coffee requires two grinding and brewing cycles, automatically carried out by the machine.

5 After the prebrewing cycle, coffee begins to pour out of the coffee dispensing spout.

6 Coffee or espresso brewing automatically stops when the preset level is reached; press the “☕_{MEMO}” button to stop it earlier.

Brewing Espresso and Coffee Using Pre-Ground Coffee

This function allows you to use pre-ground and decaffeinated coffee.

With the pre-ground coffee function you can only brew one coffee at a time.



Green





1 Press the “” button to select the pre-ground coffee function.

2 Lift the pre-ground coffee compartment lid and add one level measuring scoop of pre-ground coffee. Use only the measuring scoop supplied with the machine. Then close the pre-ground coffee compartment lid.



Warning:

Add only pre-ground coffee to the pre-ground coffee compartment. Other substances and objects may cause severe damage to the machine. Such damage will not be covered by warranty.

3 Press the “” button for an espresso or the “” button for a coffee. The brewing cycle starts.

4 After the prebrewing cycle, coffee begins to pour out of the coffee dispensing spout.

5 Coffee brewing automatically stops when the preset level is reached; press the “” button to stop it earlier.

After brewing, the machine returns to the main menu.

Repeat the steps described above to brew more coffees using pre-ground coffee.



Note:

If no pre-ground coffee is poured into the pre-ground coffee compartment, only water will be dispensed.

If more measuring scoops have been added, the machine will not brew the product and the ground coffee in the compartment will be discharged into the coffee grounds drawer.

MILK CARAFE

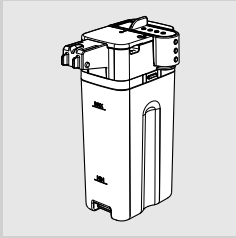

This chapter explains how to use the milk carafe to prepare a cappuccino or to froth milk.



Note:

Before using the milk carafe, clean it thoroughly as described in the “Cleaning and Maintenance” chapter.

We recommend filling it with cold milk (approx. 5°C).



Warning:

Do not use any other liquids than water for cleaning or milk.

Filling the Milk Carafe

The milk carafe can be filled before or during use.

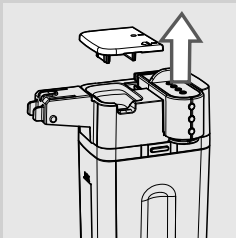

- 1 Lift the carafe lid as shown in the figure.

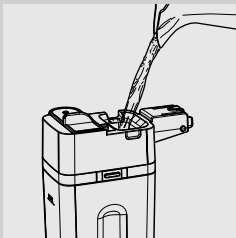

- 2 Pour the milk into the milk carafe: the milk level must be between the minimum (MIN) and maximum (MAX) level indicators shown on the milk carafe.

- 3 The milk carafe is now ready for use.

Inserting the Milk Carafe

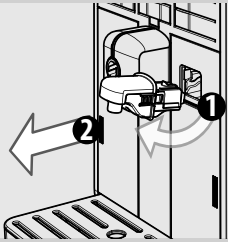

- 1** If installed, remove the water dispensing spout as shown in the figure:
 - Press the two buttons on the side to unlock the water dispensing spout and lift it slightly;
 - Pull the water dispensing spout to remove it.

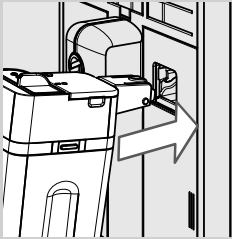

- 2** Slightly tilt the milk carafe. Insert it all the way into the guides of the machine.

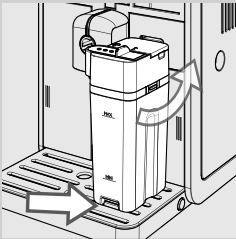

- 3** Push the carafe towards the bottom while rotating it at the same time, until it is locked onto the drip tray. Do not force the carafe while inserting it.

Removing the Milk Carafe

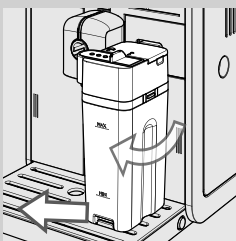

- 1** Rotate the carafe upwards until it is released from the insert in the drip tray. Then remove it.

Emptying the Milk Carafe

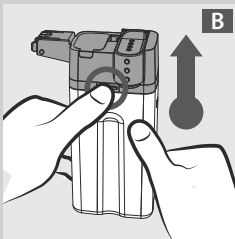
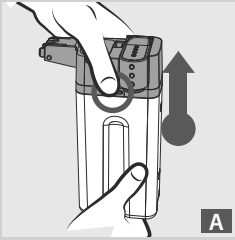

- 1 Press one of the release buttons to remove the top of the carafe as shown in the figures (A or B).

- 2 Lift the top of the carafe. Empty the milk carafe and clean it properly.

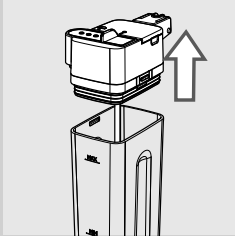

Note:

After each use, clean the milk carafe as described in the "Cleaning and Maintenance" chapter.

BREWING A CAPPUCCINO



Warning:

Danger of scalding! Dispensing may be preceded by jets of milk and steam. Wait until the end of the cycle before removing the milk carafe.

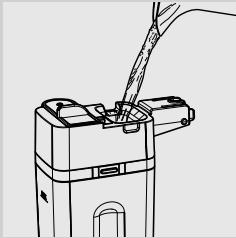

1

Fill the milk carafe with milk. The milk level must be between the minimum (MIN) and maximum (MAX) level indicators shown on the milk carafe.



Note:

Use cold (~5 °C / 41°F) milk with a protein content of at least 3% to ensure optimum results when preparing a cappuccino. Whole milk or skimmed milk may be used depending on individual taste.

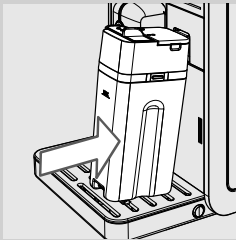

2

Insert the carafe into the machine.



3

Pull out the milk carafe dispenser to the left up to the "☁" icon.



Note:

If the milk carafe dispenser has not been pulled all the way out, milk may not be properly frothed.

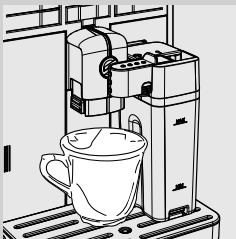

4

Place a cup under the carafe dispenser.

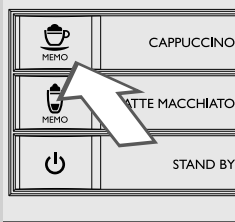

5 Press the “MEMO” button to start dispensing.



6 The machine reminds you to insert the carafe and remove the carafe dispenser by showing the following icons.

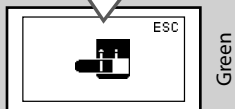
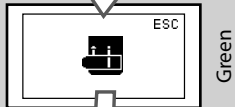

7 This icon is displayed during the preheating time required by the machine.

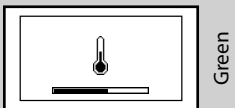

8 When this icon is shown, the machine dispenses milk. Dispensing can be stopped by pressing the “MEMO” button.



9 Once frothed milk has been dispensed, the machine brews coffee. Brewing can be stopped by pressing the “MEMO” button.



10 Once brewing has been completed, this display is shown to prompt you to start the quick carafe rinse cycle. You must react within 10 seconds as described in the "Quick carafe rinse cycle" chapter.

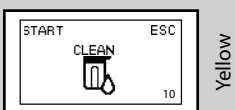

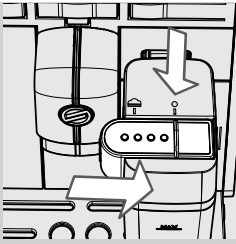

- 11 Insert the milk carafe dispenser back by sliding it up to the "●" icon.

Note:

After using the milk carafe, clean it as described in the "Cleaning and Maintenance" chapter.

You can prepare a cappuccino with pre-ground coffee. Press the "☕" button to select pre-ground coffee and pour pre-ground coffee into the compartment.

Adjusting the Cappuccino Length

Each time the "☕" button is pressed, the machine brews a pre-set quantity of cappuccino into the cup. The machine allows you to adjust the amount of cappuccino brewed according to your taste and the size of your cups.

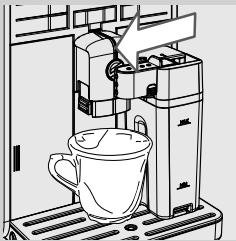

- 1 Fill the carafe with milk and place it into the machine.
- 2 Pull out the milk carafe dispenser to the left up to the "☕" icon. Place a cup under the carafe dispenser.

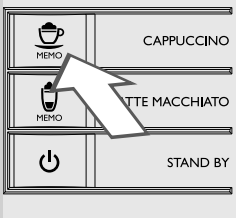

- 3 Press and hold the "MEMO" button until the "MEMO" icon appears on the display. Then release the button. The machine is now in programming mode.



Green

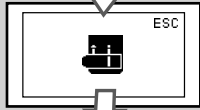

Green

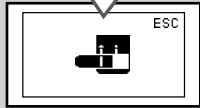

Green

- 4** The machine reminds you to insert the carafe and remove the carafe dispenser by showing the following icons.

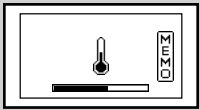

Green

- 5** This icon is displayed during the preheating time required by the machine.



Green

- 6** When the machine shows this icon, the machine starts dispensing frothed milk into the cup. When the desired quantity of frothed milk is reached, press the "MEMO" button.



Green

- 7** Once frothed milk has been dispensed, the machine starts brewing coffee. When the desired quantity is reached, press the "MEMO" button.



Green

The "MEMO" button is now programmed. Every time it is pressed, the machine will brew the same amount of cappuccino that was programmed.

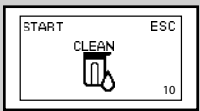

Yellow

- 8** Once brewing has been completed, this display is shown to prompt you to start the quick carafe rinse cycle. You must react within 10 seconds as described in the "Quick carafe rinse cycle" chapter.

LATTE MACCHIATO BREWING

**Warning:**

Danger of scalding! Dispensing may be preceded by jets of milk and steam. Wait until the end of the cycle before removing the milk carafe.

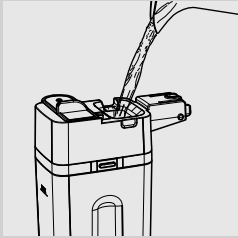
**1**

Fill the milk carafe with milk. The milk level must be between the minimum (MIN) and maximum (MAX) level indicators shown on the milk carafe.

**Note:**

Use cold (~5 °C / 41°F) milk with a protein content of at least 3% to ensure optimum results when preparing a cappuccino. Whole milk or skimmed milk may be used depending on individual taste.

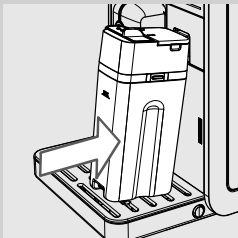
**2**

Insert the carafe into the machine.

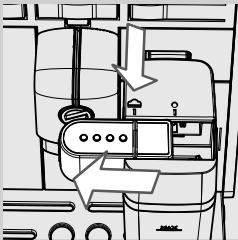
**3**

Pull out the milk carafe dispenser to the left up to the “” icon.

**Note:**

If the milk carafe dispenser has not been pulled all the way out, milk may not be properly frothed.

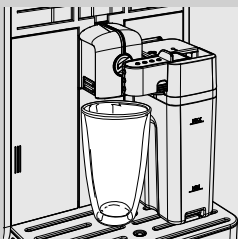
**4**

Place a cup under the carafe dispenser.

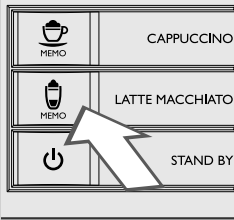

5 Press the “MEMO” button to select Latte Macchiato brewing.



Green

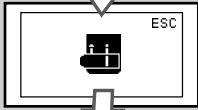

Green

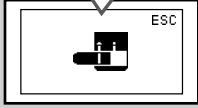

Green

6 The machine reminds you to insert the carafe and remove the carafe dispenser by showing the following icons.

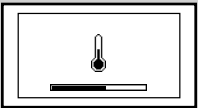

Green

7 This icon is displayed during the preheating time required by the machine.



Green

8 When this icon is shown, the machine dispenses milk. Brewing can be stopped by pressing the “MEMO” button.

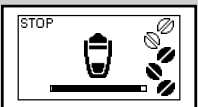

Green

9 Once frothed milk has been dispensed, the machine brews coffee. Brewing can be stopped by pressing the “MEMO” button.

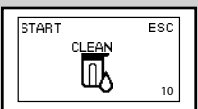

Yellow

10 Once brewing has been completed, this display is shown to prompt you to start the quick carafe rinse cycle. You must react within 10 seconds as described in the "Quick carafe rinse cycle" chapter.

**Note:**

After using the milk carafe, clean it as described in the "Cleaning and Maintenance" chapter.

You can prepare a Latte Macchiato with pre-ground coffee. Press the "☕" button to select pre-ground coffee and pour pre-ground coffee into the compartment.

Adjusting the Latte Macchiato length

Each time the "☕" button is pressed, the machine brews a pre-set quantity of Latte Macchiato into the cup.

The machine allows you to adjust the dispensed amount of Latte Macchiato according to your taste and the size of your cups.

- 1 Fill the carafe with milk and place it into the machine.
- 2 Pull out the milk carafe dispenser to the left up to the "☕" icon. Place a cup under the carafe dispenser.

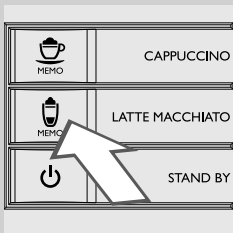
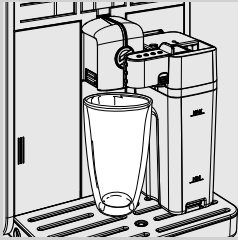

- 3 Press and hold the "☕" button until the "MEMO" icon appears on the display. Then release the button. The machine is now in programming mode.



Green

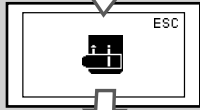

Green

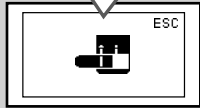

Green

4 The machine reminds you to insert the carafe and remove the carafe dispenser by showing the following icons.

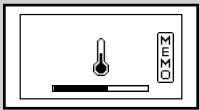

Green

5 This icon is displayed during the preheating time required by the machine.



Green

6 When the machine shows this icon, the machine starts dispensing frothed milk into the cup. When the desired quantity of frothed milk is reached, press the "MEMO" button.



Green

7 Once frothed milk has been dispensed, the machine starts brewing coffee. When the desired quantity is reached, press the "MEMO" button.



Green

The "MEMO" button is now programmed. Every time it is pressed, the machine will brew the same amount of Latte Macchiato that was programmed.

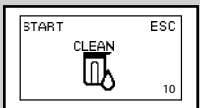

Yellow

8 Once brewing has been completed, this display is shown to prompt you to start the quick carafe rinse cycle. You must react within 10 seconds as described in the "Quick carafe rinse cycle" chapter.

FROTHING MILK



Warning:

Danger of scalding! Dispensing may be preceded by jets of milk and steam. Wait until the end of the cycle before removing the milk carafe.

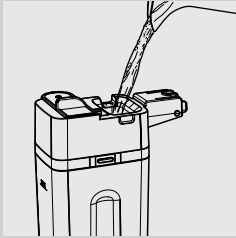

1

Fill the milk carafe with milk. The milk level must be between the minimum (MIN) and maximum (MAX) level indicators shown on the milk carafe.



Note:

Use cold (~5 °C / 41°F) milk with a protein content of at least 3% to ensure optimum results when preparing a cappuccino. Whole milk or skimmed milk may be used depending on individual taste.

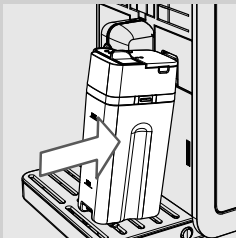

2

Insert the carafe into the machine.



3

Pull out the milk carafe dispenser to the left up to the “” icon.



Note:

If the milk carafe dispenser has not been pulled all the way out, milk may not be properly frothed.

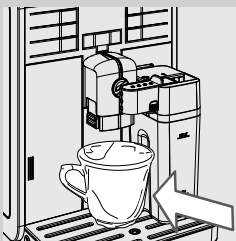

4

Place a cup under the carafe dispenser.

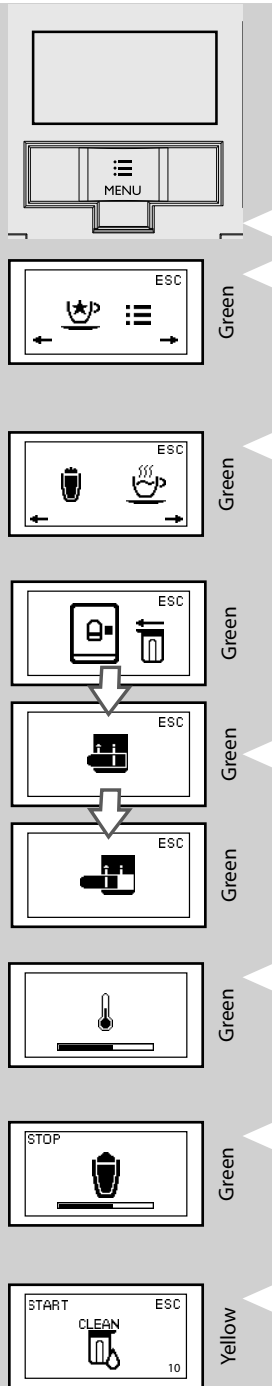

5 Press the “” **MENU** button. This icon is displayed.

6 Press the “” button. This icon is displayed.

7 Press the “” button to select frothed milk.

8 The machine reminds you to insert the carafe and remove the carafe dispenser by showing the following icons.

9 This icon is displayed during the preheating time required by the machine.

10 The machine dispenses a predefined quantity of frothed milk into the cup. Brewing can be stopped by pressing the “” button.

11 Once brewing has been completed, this display is shown to prompt you to start the quick carafe rinse cycle. You must react within 10 seconds as described in the "Quick carafe rinse cycle" chapter.



Note:

After using the milk carafe, clean it as described in the "Cleaning and Maintenance" chapter.

Adjusting the Frothed Milk Length

Each time this function is selected, the machine dispenses a preset amount of frothed milk into the cup. The machine allows you to adjust the amount of frothed milk according to your taste and the size of your cups.

- 1 Fill the carafe with milk and place it into the machine.
- 2 Pull out the milk carafe dispenser to the left up to the "☕" icon. Place a cup under the carafe dispenser.

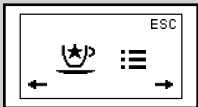
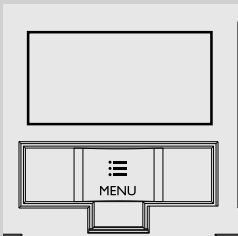

Green

- 3 Press the "☰" **MENU** button. This icon is displayed.



Green

- 4 Press the "☕" **MEMO** button. This icon is displayed.

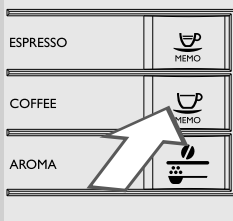

Green

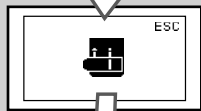

Green

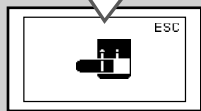

Green

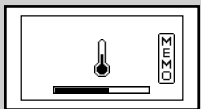

Green



Green



Green

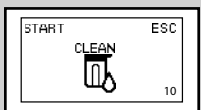

Yellow

5 Press and hold the “” button to select frothed milk until the “MEMO” icon appears on the display. Then release the button. The machine is now in programming mode.

6 The machine reminds you to insert the carafe and remove the carafe dispenser by showing the following icons.

7 This icon is displayed during the preheating time required by the machine.

8 When the desired amount of frothed milk is reached, press the “” button.

Now the “frothed milk” button is programmed. Every time it is pressed, the machine will brew the same amount of frothed milk that was programmed.

9 Once brewing has been completed, this display is shown to prompt you to start the quick carafe rinse cycle. You must react within 10 seconds as described in the “Quick carafe rinse cycle” chapter.

QUICK CARAFE RINSE CYCLE

After one or more milk-based products have been prepared, the machine allows for a quick cleaning of the carafe ducts.

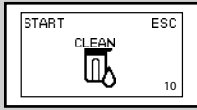

Yellow

- 1 This screen is displayed for 10 seconds to prompt you to perform the quick rinse cycle. Press the "MEMO" button within the following 10 seconds to start the cycle.

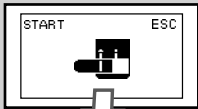

Yellow

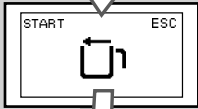

Yellow

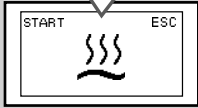

Yellow

- 2 The following screens are displayed in sequence until the cycle starts.
 1. Pull out the carafe dispenser up to the "MEMO" icon.
 2. Place a container under the carafe dispenser.
 3. Be careful when starting the cycle. Hot water is dispensed.

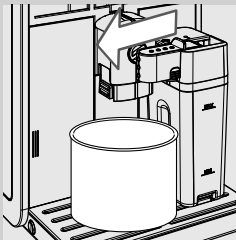

- 3 Press the "MEMO" button. The rinse cycle starts.

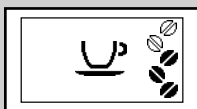

Green

- 4 Once rinsing has been completed, the following screen is displayed and the machine is ready for use. Remove the container and the milk carafe.

DISPENSING HOT WATER

**Warning:**

Danger of scalding! Dispensing may be preceded by small jets of hot water and steam. Wait until the end of the cycle before removing the water dispensing spout.

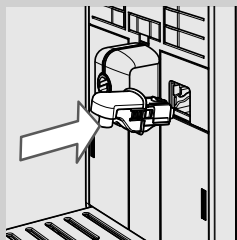

- 1 Slightly tilt the water dispensing spout and insert it all the way in into the guides of the machine.

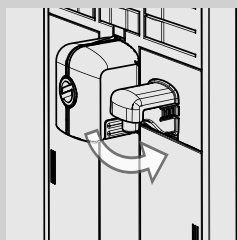

- 2 Push the water dispensing spout towards the bottom while rotating it at the same time, until it is locked in the machine as shown in the figure.



- 3 Place a container under the hot water dispensing spout.

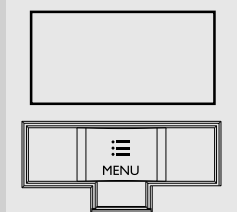

- 4 Press the  MENU button. This icon is displayed."/> MENU button. This icon is displayed.

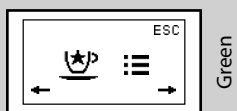



Green

5 Press the “” button. This icon is displayed.

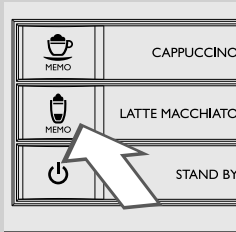

6 Press the “” button to start dispensing.



Green

7 This icon is displayed. The machine reminds you to install the water dispensing spout. Check that the water dispensing spout is correctly installed. Press “” to confirm. The machine will start dispensing hot water.

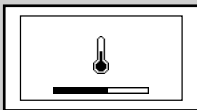

Green

8 This icon is displayed during the preheating time required by the machine.



Green

9 Dispense the desired amount of hot water. To stop the hot water dispensing process, press the “” button.

CLEANING AND MAINTENANCE

Daily Cleaning of the Machine



Caution:

Timely cleaning and maintenance of your machine is very important as it prolongs the life of your machine. The machine is continuously exposed to humidity, coffee and limescale!

The activities you need to perform and their frequency are described in detail in this chapter. Not doing this will ultimately make your machine stop working properly. This repair is NOT covered by warranty!



Note:

- Use a soft, dampened cloth to clean the machine.
- Only the parts of the carafe described in the "Weekly Cleaning of the Milk Carafe" section can be washed in the dishwasher. Any other components must be washed with lukewarm water.
- Do not immerse the machine in water.
- Do not use alcohol, solvents, and/or abrasive objects to clean the machine.
- Do not dry the machine and/or its components using a microwave and/or standard oven.

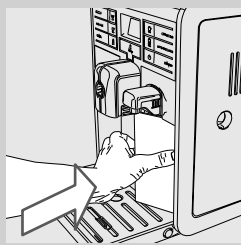

- 1** Empty and clean the coffee grounds drawer daily with the machine turned on.

- Press gently on the side of the coffee grounds drawer door to release the handgrip.
- Remove the coffee grounds drawer by pulling it by the handle.

Other maintenance operations can only be carried out when the machine is turned off and unplugged.

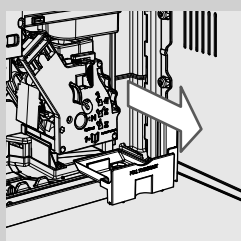

- 2** Empty and clean the coffee residues drawer located inside of the machine. Open the service door, remove the drawer and empty it.

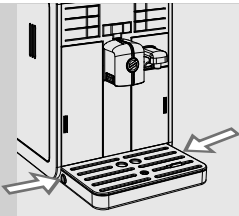

3 Empty and wash the drip tray:

- Press the side buttons.
- Remove the drip tray.

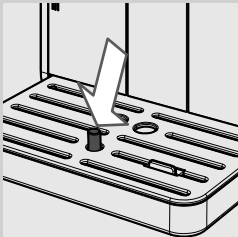
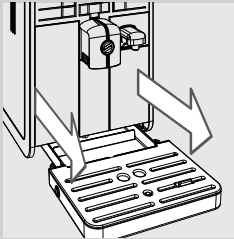

Note:

Empty and wash the drip tray also when the full drip tray indicator is raised.

Daily Cleaning of the Water Tank

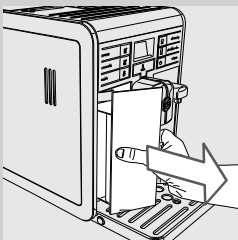

- 1 Remove the small white filter or the INTENZA+ water filter (if installed) from the water tank and wash it with fresh water.
- 2 Put the small white filter back or the INTENZA+ water filter (if installed) in its housing by gently pressing and turning it at the same time.
- 3 Fill the water tank with fresh water.

Daily Cleaning of the Milk Carafe

In addition to the quick carafe rinse cycle, we recommend that you also clean the carafe daily as described below. This preserves hygiene and ensures a perfect frothed milk consistency.

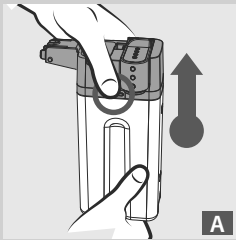

A

- 1 Press one of the release buttons to remove the top of the carafe as shown in the figures (A or B).

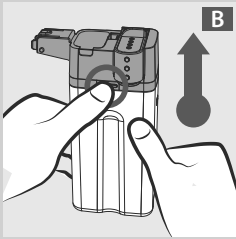

B

- 2 Remove the lid.

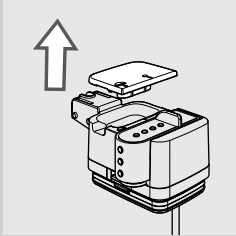

- 3 Lift the carafe dispenser to remove it from the top of the carafe.

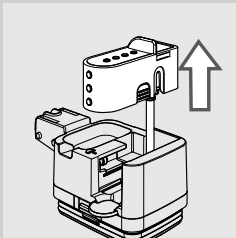

- 4 Remove the suction tube with the fitting (A) from the milk frother.

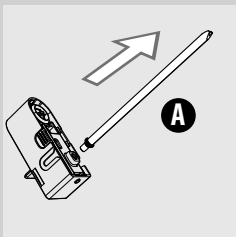

A

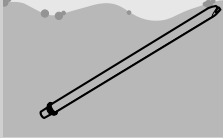

5 Wash the suction tube with the fitting thoroughly with fresh water.

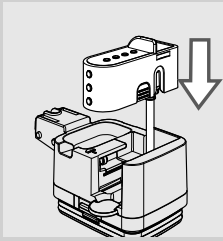

6 After installing the suction tube with the fitting, insert the dispensing spout on the top of the carafe.

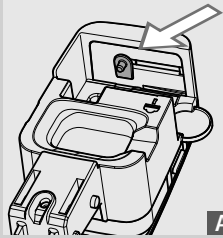

A

7 If you cannot install the dispenser at the top of the carafe, the pin is in the wrong position (B). Before installing the dispenser, manually push the pin to the (A) position.

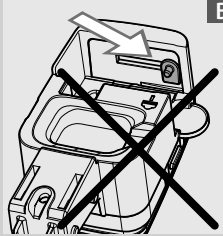

B

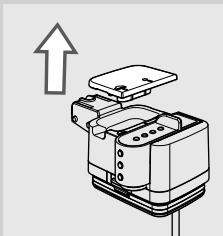

8 Insert the lid.

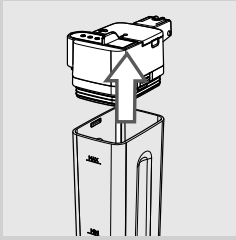

- 9 Place the top of the carafe back in position.

Weekly Cleaning of the Machine

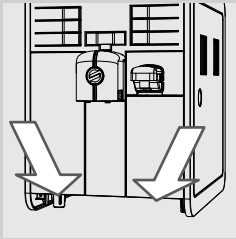

- 1 Clean the seat of the drip tray.

Weekly Cleaning of the Milk Carafe

The weekly cleaning is more thorough since all milk residues are removed from the carafe dispenser.

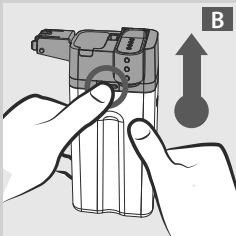
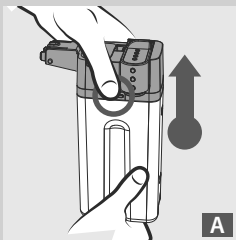

- 1 Press one of the release buttons to remove the top of the carafe as shown in the figures (A or B).

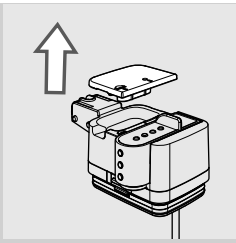

2 Remove the lid.

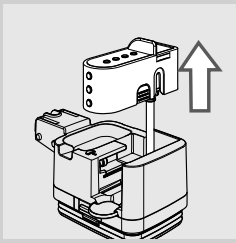

3 Lift the dispensing spout to remove it from the top of the carafe. The milk carafe dispenser is made up of six parts that must be disassembled. Each part is indicated by a capital letter (A, B, C, D, E, F) as shown in the figures below.

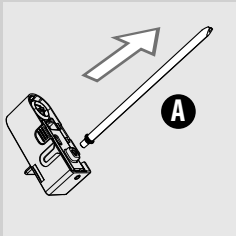

4 Remove the suction tube with the fitting (A) from the milk frother.

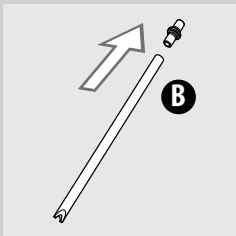

5 Remove the fitting (B) from the suction tube.

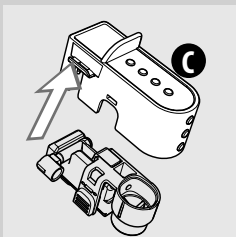

6 Detach the lid (C) from the milk carafe dispenser by pushing downwards while slightly pressing on the sides.

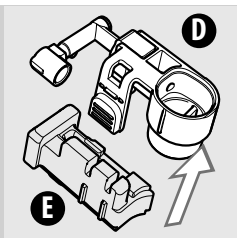

7 Remove the milk frothing device (D) from the support (E).

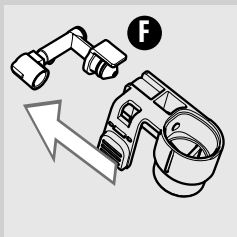

8 Remove the fitting (F) from the milk frothing device by pulling it outwards.

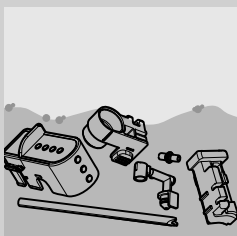

9 Clean all the parts thoroughly with lukewarm water.



Note:

You can also clean these parts in the dishwasher.

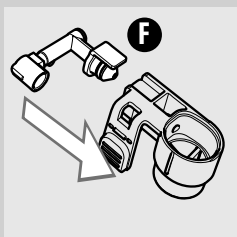

10 Insert the fitting (F) into the milk frothing device by pressing it up to its limit.

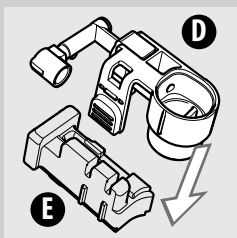

11 Insert the milk frothing device (D) into the support (E).

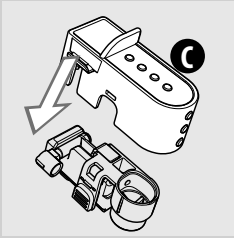

12 Attach the top (C) to the carafe dispenser.

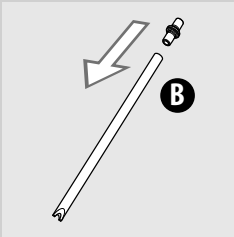

13 Insert the fitting (B) into the suction tube.

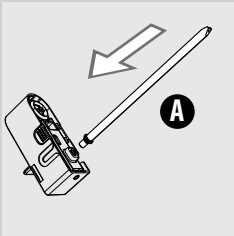

14 Insert the suction tube with the fitting (A) into the milk frother.

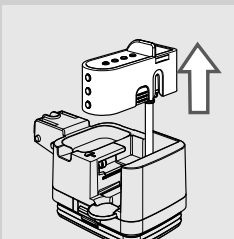

15 Insert the dispenser into the top part of the carafe.

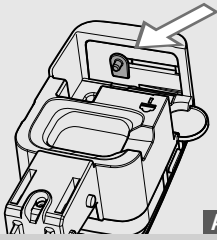

A



B

16 If you cannot install the dispenser at the top of the carafe, the pin is in the wrong position (B). Before installing the dispenser, manually push the pin to the (A) position.

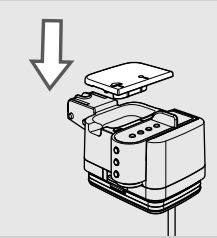

17 Insert the lid.

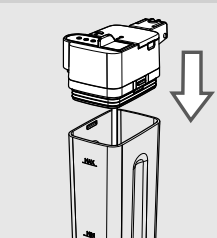

18 Attach the top of the milk carafe, ensuring it is locked into place.

Weekly Cleaning of the Brew Group

The brew group should be cleaned every time the coffee bean hopper is filled or at least once a week.

- 1 Turn off the machine by pressing the "⏻" button and unplug the power cord.
- 2 Remove the coffee grounds drawer. Open the service door.

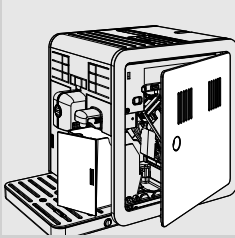

- 3 Remove and clean the coffee residues drawer.

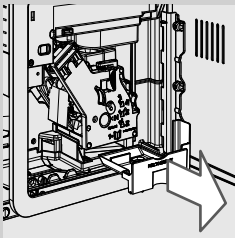

- 4 To remove the brew group, press the «PUSH» button and pull it by the handle.

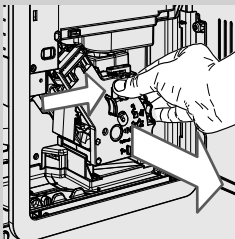

- 5 Thoroughly wash the brew group with fresh, lukewarm water and carefully clean the upper filter.

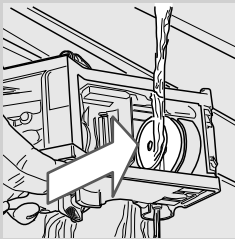

! **Caution:**
Do not use any detergent or soap to clean the brew group.

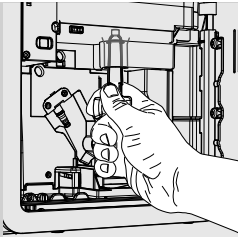

6 Let the brew group air-dry thoroughly.

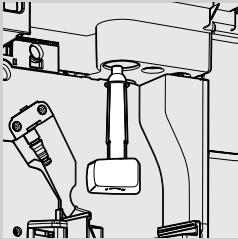

7 Thoroughly clean the coffee duct outlet with the special cleaning tool supplied with the machine or with a spoon handle. Make sure that the cleaning tool is inserted as shown in the figure.

8 Thoroughly clean the inside of the machine using a soft, dampened cloth.

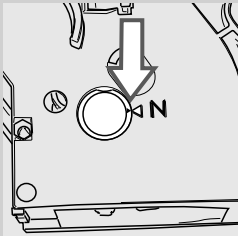

9 Make sure that the brew group is in the off position; the two reference marks must match. If they do not match, proceed as described in step (10).

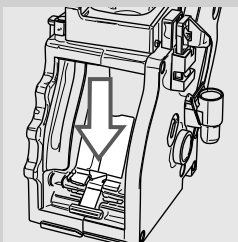

10 Make sure that the lever on the back of the brew group is completely lowered.

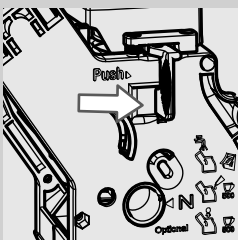

11 Press the "PUSH" button firmly.

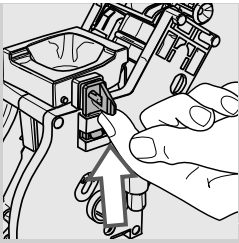

- 12** Make sure that the hook which locks the brew group is in the correct position. If it is still in the downward position push it upward until it locks correctly into place.

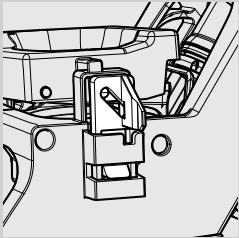

- 13** Insert the brew group back into its seat until it locks into place without pressing the "PUSH" button.

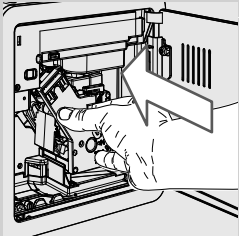

- 14** Insert the coffee residues drawer and close the service door.

- 15** Insert the coffee grounds drawer.

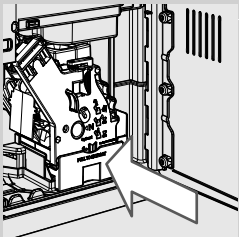

Weekly Cleaning of the Coffee Bean Hopper, Tray and Coffee Compartment

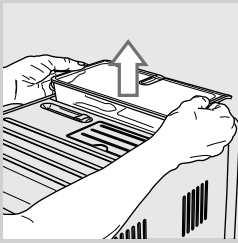

1 Remove the coffee bean hopper.

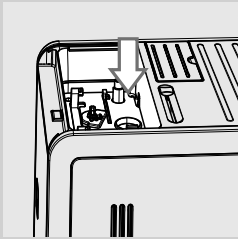

2 Clean the coffee bean hopper, tray and coffee compartment once a week with a cloth to remove any coffee residues and dust.

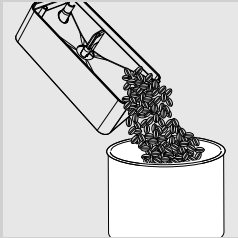

3 Empty any beans out of the coffee bean hopper.

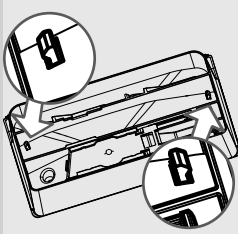

4 To remove the tray, press on the hooks on the bottom of the coffee bean hopper as shown in the figure.

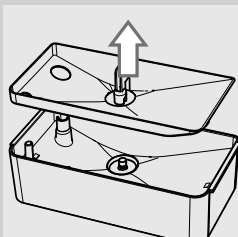

5 Remove the tray. Clean the tray and the coffee bean hopper with a cloth.

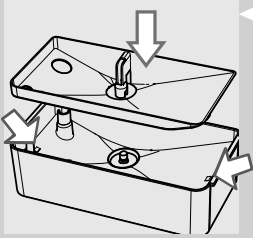

6 After cleaning, insert the tray back into the coffee bean hopper. Insert the tray hooks into their seats on the coffee bean hopper.

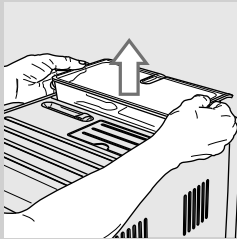

7 Insert the coffee bean hopper into the compartment.

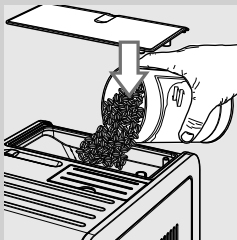

8 Slowly pour in the coffee beans. Put the lid.

Monthly Cleaning of the Milk Carafe



For the monthly cleaning cycle we recommend using the “Saeco Milk Circuit Cleaner” to keep the entire circuit clean of milk residues. The “Saeco Milk Circuit Cleaner” can be purchased separately. Please refer to the maintenance products page for further details.



Warning:

Danger of scalding! Dispensing may be preceded by small jets of hot water and steam. Wait until the end of the cycle before removing the milk carafe.

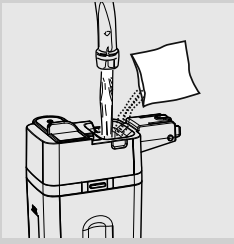

1 Fill the milk carafe with water up to the maximum level (MAX).

2 Pour the milk cleaner bag into the milk carafe and let it dissolve completely.

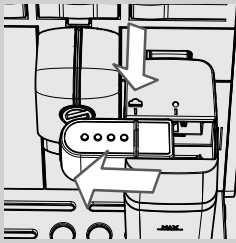

3 Insert the carafe into the machine. Pull out the milk carafe dispenser to the left up to the "☞" icon.

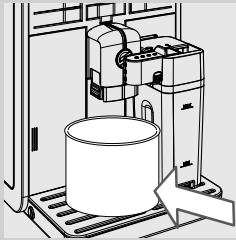

4 Place a container under the carafe dispenser.

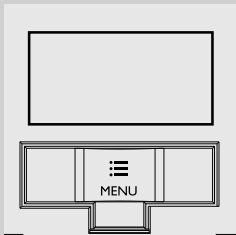

5 Press the "☰" MENU button. This icon is displayed.

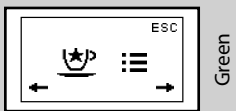

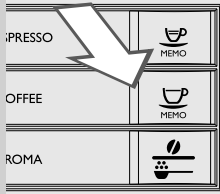

Green



Green

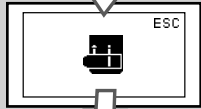

Green

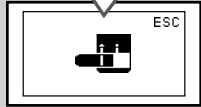

Green

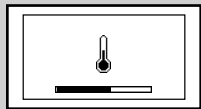

Green

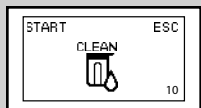

Green

6 Press the "MEMO" button. This icon is displayed.

Press the "MEMO" button to select frothed milk.

7 The machine reminds you to insert the carafe and remove the carafe dispenser by showing these icons in sequence.

8 This icon is displayed during the preheating time required by the machine.

9 Once dispensing has been completed, the following screen is displayed to prompt you to start the quick carafe rinse cycle. Press the "MEMO" button to quit the program.

10 Repeat steps 5 to 9 until the carafe is emptied.



Warning:

Never drink the solution dispensed during this step.

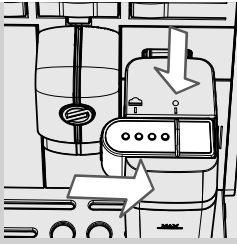

11 Insert the milk carafe dispenser back by sliding it up to the "●" icon.

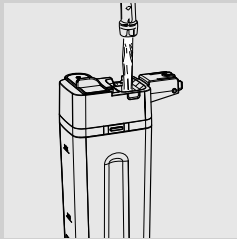

12 Remove the milk carafe and the container from the machine.

13 Rinse and fill the milk carafe with fresh water up to the MAX level.

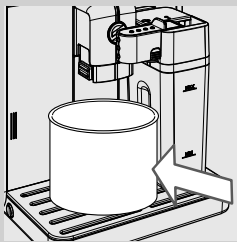

14 Insert the milk carafe into the machine. Pull out the milk carafe dispenser to the left up to the "▲" icon. Place a container under the carafe dispenser to start the rinse cycle.

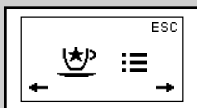

Green

15 Press the "☰" **MENU** button. This icon is displayed.



Green

16 Press the "MEMO" button. This icon is displayed.

Press the "MEMO" button to select frothed milk.



Green

17 The machine reminds you to insert the carafe and remove the carafe dispenser by showing these icons in sequence.

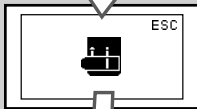

Green

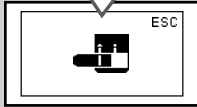

Green

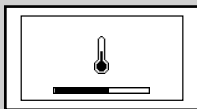

Green

18 This icon is displayed during the preheating time required by the machine.

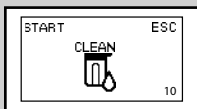

Green

19 Once dispensing has been completed, the following screen is displayed to prompt you to start the quick carafe rinse cycle. Press the "MEMO" button to quit the program.

20 Repeat steps 15 to 19 until the carafe is emptied.

21 Remove the milk carafe and the container from the machine. Repeat steps 12-19 one more time.

22 Disassemble and wash the milk carafe as described in the "Weekly Cleaning of the Milk Carafe" chapter.

Monthly Lubrication of the Brew Group

Lubricate the brew group after approximately 500 cups of coffee or once a month.

The grease to lubricate the brew group can be purchased separately. For further details, please refer to the maintenance products page in this user manual.



! **Caution:**

Before lubricating the brew group, clean it with fresh water and let it dry as described in the “Weekly Cleaning of the Brew Group” chapter.

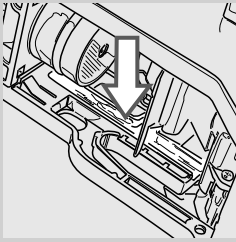

- 1** Apply the grease evenly on both side guides.

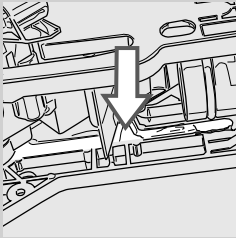

- 2** Also lubricate the shaft.

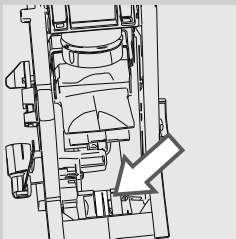
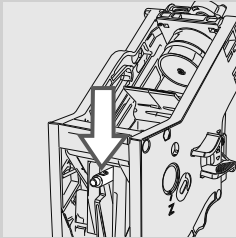

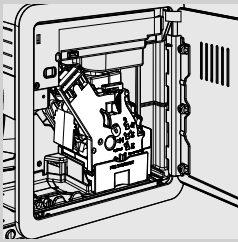

3 Insert the brew group into its seat until it locks into place (see the “Weekly Cleaning of the Brew Group” chapter). Insert the coffee residues drawer.

4 Close the service door. Insert the coffee grounds drawer.

Monthly Cleaning of the Brew Group with “Coffee Oil Remover”



Besides weekly cleaning, we recommend performing a cleaning cycle with “Coffee Oil Remover” after approximately 500 cups of coffee or once a month. This operation completes the maintenance process for the brew group.

You can purchase the “Coffee Oil Remover” separately. For further details, please refer to the maintenance products page in this user manual.



Caution:

The “Coffee Oil Remover” tablets are to be used for cleaning only and do not have a descaling function. For the descaling procedure use the Saeco descaling solution and follow the procedure described in the “Descaling” chapter.

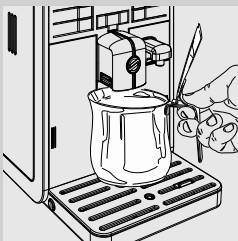

1 Place a container under the coffee dispensing spout.

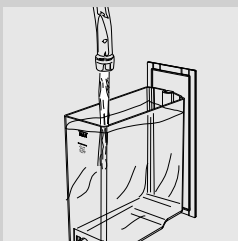

2 Make sure the water tank is filled with fresh water up to the “MAX” level.

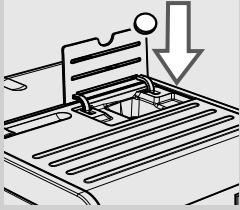

Green

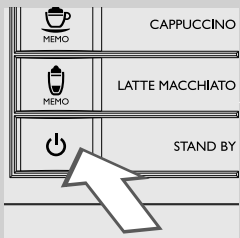
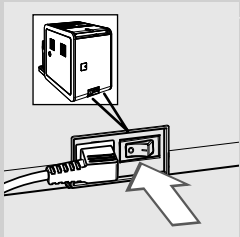

3 Put a “Coffee Oil Remover” tablet in the pre-ground coffee compartment.

4 Press the “☕” button to select the pre-ground coffee function. Do not add any ground coffee.

5 Press the “MEMO” button to start a coffee brewing cycle.

6 Wait until the machine has dispensed half a cup of water.

7 Switch the power button on the back of the machine to “0”.

8 Let the solution take effect for about 15 minutes. Make sure you discard the dispensed water.

9 Switch the power button on the back of the machine to “I”. To turn on the machine, press the “☰” button. Wait until the end of the automatic rinse cycle.

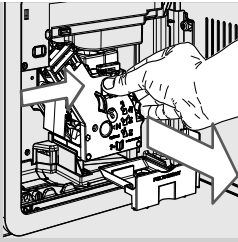

- 10** Remove the coffee grounds drawer and open the service door. Remove the coffee residues drawer and then the brew group.

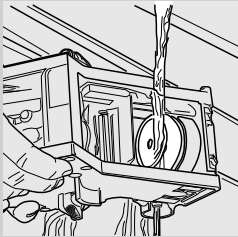

- 11** Wash the brew group thoroughly with fresh water.

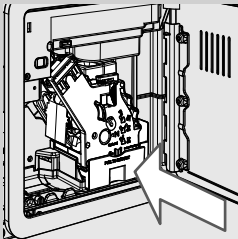

- 12** After rinsing the brew group, insert it back into its seat until it locks into place (see the “Weekly Cleaning of the Brew Group” chapter). Insert the coffee residues drawer and the coffee grounds drawer. Close the service door.



Green

- 13** Press the “☕” button to select the pre-ground coffee function. Do not add any coffee to the pre-ground coffee department.

- 14** Press the “☕
MEMO” button to start a coffee brewing cycle.

- 15** Repeat steps 13 to 14 twice. Empty the container.

- 16** To clean the drip tray, place a “Coffee Oil Remover” tablet inside and fill it 2/3rds full with hot water. Let the cleaning solution take effect for about 30 minutes, then rinse thoroughly.

DESCALING



Yellow

When the "CALC CLEAN" icon is displayed, you need to descale the machine.

The descaling cycle takes approx. 30 minutes.

**Caution:**

Not doing this will ultimately make your machine stop working properly. In this case, repair is NOT covered by warranty.

**Warning:**

Use the Saeco descaling solution only. Its formula has been designed to ensure better machine performance. The use of other products may damage the machine and leave residues in the water.



The Saeco descaling solution can be purchased separately. For further details, please refer to the maintenance products page in this manual.

**Warning:**

Never drink the descaling solution or any products dispensed until the cycle has been carried out to the end. Never use vinegar as a descaling solution.

**Note:**

Do not remove the brew group during the descaling process.

To perform the descaling cycle, follow the steps below:

Before descaling:

- 1** Empty the drip tray.

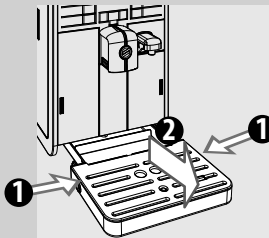

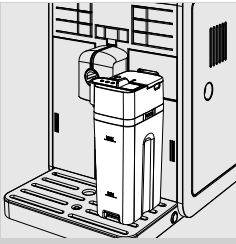

2 Fill the milk carafe with water up to the MIN level and insert it into the machine.

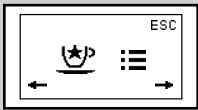

Green

3 Press the "☰" **MENU** button. This icon is displayed.



Yellow

4 Press the "MEMO" button. Press the "MEMO" button until this icon is shown.

5 Press the "MEMO" button to start the descaling process.



Yellow

6 The machine reminds you to insert the carafe and remove the carafe dispenser by showing the following icons.

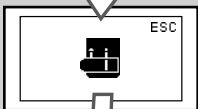

Yellow

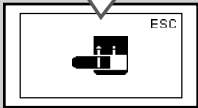

Yellow

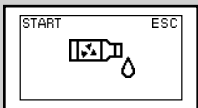

Yellow



Note:

If the "MEMO" button is pressed by mistake, press the "MEMO" button to quit.

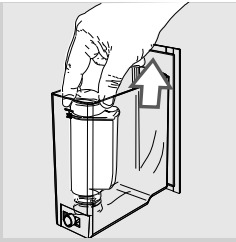

7 Remove the "INTENZA+" water filter (if any) from the water tank and replace it with the small white original one.

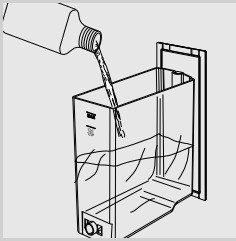

8 Pour all the descaling solution into the water tank. Then fill the water tank with fresh water up to the CALC CLEAN level.

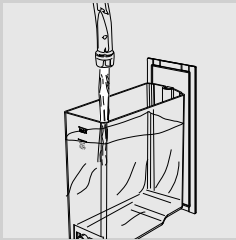

9 Put the water tank back into the machine.

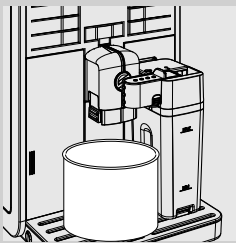

10 Pull out the milk carafe dispenser to the left up to the "☕" icon. Place a large container (1.5 l) under both the milk carafe dispenser and the coffee dispensing spout.

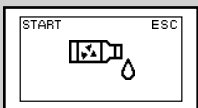

Yellow

11 Press the "☕" button to start the descaling cycle.

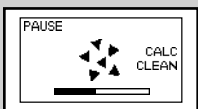

Yellow

12 The machine will start dispensing the descaling solution at regular intervals. The bar on the display shows the cycle progress.

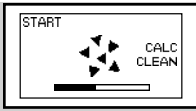

Yellow



Note:

The descaling cycle may be paused by pressing the “MEMO” button. To resume the cycle, press the “MEMO” button again. This allows you to empty the container or to leave the machine unattended for a short time.



Red

13 When this icon is displayed, the water tank is empty.

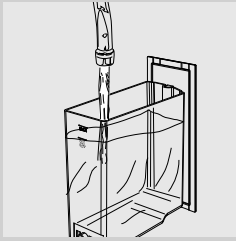

14 Rinse the water tank and fill it with fresh water up to the MAX level. Put it back into the machine.

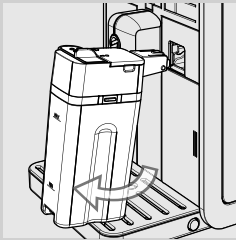

15 Remove and empty the container and the milk carafe.

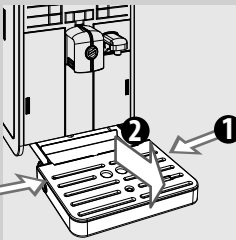

16 Empty the drip tray and place it back.

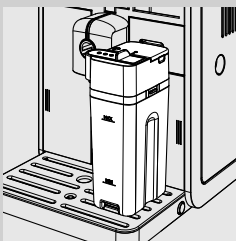

17 Fill the milk carafe with water up to the MIN level and insert it into the machine. Pull out the carafe dispenser to the left up to the “MEMO” icon.

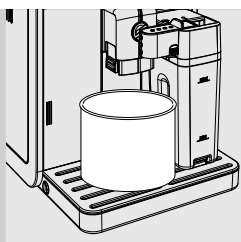

18 Place the container back into position.

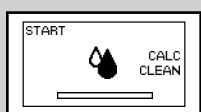

Yellow

19 Press the "MEMO" button to start the rinse cycle.

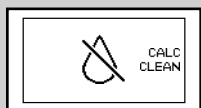

Red

20 When this icon is displayed, the water tank is empty. Rinse the water tank and fill it with fresh water up to the MAX level, then put it back into the machine and repeat step 19.

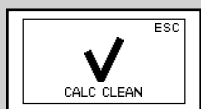

Green

21 When the amount of water needed for the rinse cycle has been completely dispensed, this icon is displayed. Press the "MEMO" button to quit the descaling cycle.



Note:

If the water tank is not filled up to MAX level, the machine might require the water tank to be filled up once more in order to complete the rinse cycle. Fill the water tank and put it back into the machine. Repeat from step 19.

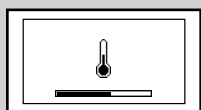

Yellow

22 The machine now carries out the warm-up and automatic rinse cycle to prepare for product brewing.

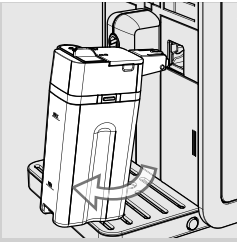

23 Remove the container. Disassemble and wash the milk carafe as described in the “Weekly Cleaning of the Milk Carafe” chapter.

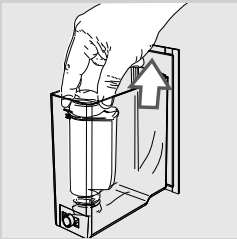

24 Remove the small white filter and place back the “INTENZA+” water filter (if any) into the water tank.

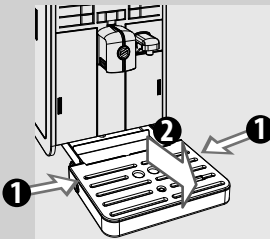

25 Empty the drip tray and place it back.

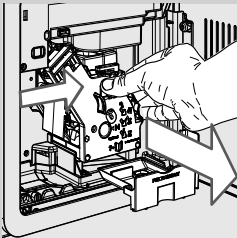

26 Clean the brew group. For more details, please see the “Brew Group Cleaning” chapter.

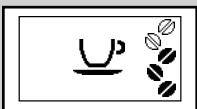

Green

27 The machine is ready to brew coffee.

ACCIDENTAL INTERRUPTION OF THE DESCALING CYCLE

Once the descaling process has started, it must be completed; do not turn off the machine mid-cycle.

If the descaling process is accidentally interrupted (power failure or accidental disconnection of the power cord), follow the steps below.

- 1 Check that the power button is set to "I".

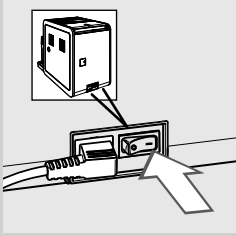

- 2 Press the "⏻" button to turn on the machine.

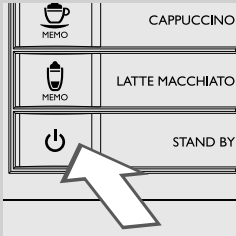

- 3 If the cycle was interrupted during the descaling phase, it will be resumed from step 12 of the "Descaling" chapter. Press the "☕
MEMO" button to restart the cycle.

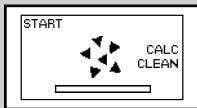

Yellow

- 4 If the cycle was interrupted during the rinse phase, it will be resumed from step 19 of the "Descaling" chapter. Press the "☕
MEMO" button to restart the cycle.



Yellow

PROGRAMMING

You can customise the machine's functions via the programming menu.

The following settings can be adjusted

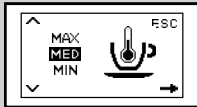

Yellow

Coffee Temperature

This function allows you to adjust the coffee brewing temperature.

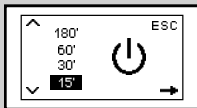

Yellow

Timer (stand-by)

This function allows you to adjust the time taken for the machine to go into stand-by mode after the last brewing.

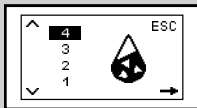

Yellow

Water Hardness

This function allows you to adjust the water hardness settings according to the area where you live.

- 1 = very soft water
- 2 = soft water
- 3 = hard water
- 4 = very hard water

For more details, please see the "Measuring and Programming Water Hardness" chapter.

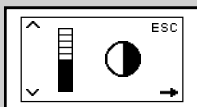

Yellow

Contrast

This function allows you to adjust the contrast of the display to better view the messages.

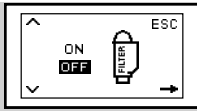

Yellow

"INTENZA+" Water Filter

This function allows you to manage the "INTENZA+" water filter. For more details, see the chapter related to filter handling.



Yellow

Descaling cycle

This function allows you to run the descaling cycle.



Yellow

Coffee bean selection

This function allows you to optimize the grinding for selected type of coffee bean.

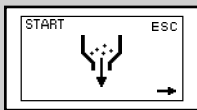

Yellow

Coffee outlet duct emptying cycle

This function allows you to empty the coffee outlet duct and grinder before changing coffee beans.



Yellow

Factory Settings

This function allows you to reset all factory values.

How to Program the Machine

In this example, it is shown how to program the display contrast. Proceed in the same way to program the other functions. The programming menu can only be accessed when the machine is on and shows this display.



Green

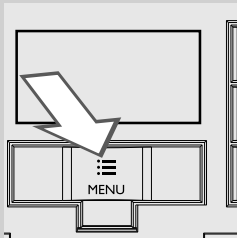

- 1 Press the “” button to access the menu.

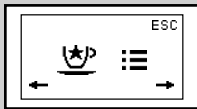

Green

- 2 Press the “” button to access programming.

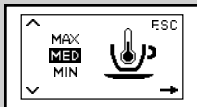

Yellow

- 3 The main screen will be displayed.

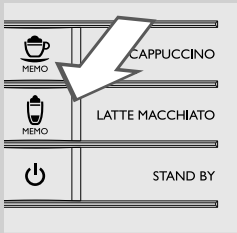

- 4 Press the “” button to scroll the options until the display contrast function is shown.



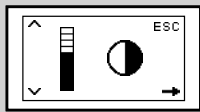
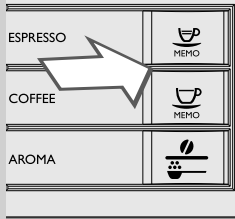

Yellow

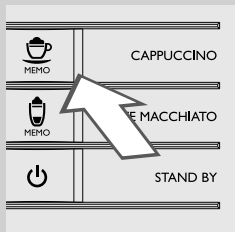
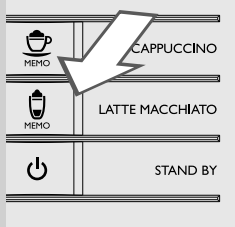

Yellow



5 Press the “” and “” buttons to increase or decrease the value of the function.

6 Once the value has been changed, the “OK” message appears. Press the “” button to confirm the change.

7 Press the “” button to exit the programming menu.

Note:

The machine automatically exits the programming menu if no button is pressed for 3 minutes. The values that have been changed but not confirmed will not be saved.

MEANING OF THE DISPLAY ICONS

This machine is equipped with a colour-coded system to make the user's understanding of the display signals easier. The icons are colour-coded according to the traffic light principle.

Ready Signals (Green Colour)



The machine is ready to brew coffee using Arabica coffee beans.



The machine is ready to brew coffee using Robusta coffee beans.



The machine is ready to brew coffee using Mixed coffee beans.

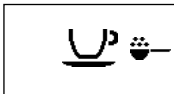

The machine is ready to brew pre-ground coffee.

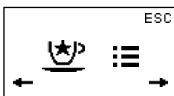

Select the programming menu or special beverages menu.



Frothed milk or hot water selection.



Hot water dispensing.



The machine is brewing one cup of espresso.



The machine is brewing one cup of coffee.

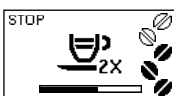

The machine is brewing two cups of espresso.

Ready Signals (Green Colour)

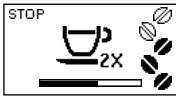

The machine is brewing two cups of coffee.



Espresso brewing using pre-ground coffee in progress.



Coffee brewing using pre-ground coffee in progress.

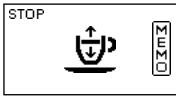

The machine is programming the amount of coffee to be brewed.



Frothed milk dispensing.



The machine is brewing cappuccino.



The machine is programming the amount of milk to be dispensed for a cappuccino.



The machine is programming the amount of coffee to be brewed for a cappuccino.



The machine is brewing Latte Macchiato.

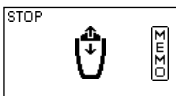

The machine is programming the amount of milk to be dispensed for the Latte Macchiato.

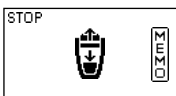

The machine is programming the amount of coffee to be brewed for the Latte Macchiato.

Ready Signals (Green Colour)



The machine is programming the amount of milk to be dispensed for frothed milk.

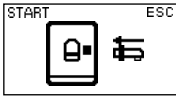

Insert the water dispensing spout and press the "MEMO" button to start dispensing. Press "MEMO" to exit.



The machine reminds you to insert the carafe and pull out the dispensing spout.



The machine is warming up to brew beverages or dispense hot water.

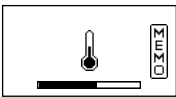

The machine is warming up during beverages programming.

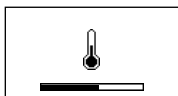
Warning Signals (Yellow Colour)

The machine is warming up.



The machine is performing a rinse cycle. Wait until the machine has completed the cycle.

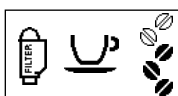

The machine needs the "INTENZA+" water filter to be replaced.



The brew group is being reset due to machine reset.

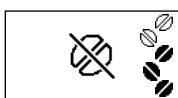

Fill the coffee bean hopper with coffee beans and restart the cycle.

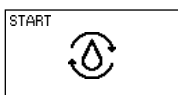

Prime the circuit.



The machine requires the carafe dispenser to be rinsed. This screen is displayed after each milk-based beverage brewing and stays active for 10 seconds only. Press the "MEMO" button to start the process or the "MEMO" button to exit.



You need to descale the machine. Press the "MEMO" button to start the descaling process. Follow the steps described in the "Descaling" chapter of this manual. If you want to descale the machine later, press the "MEMO" button to continue using the machine.

Please note that not descaling your machine will ultimately make it stop working properly. In this case repair is NOT covered under your warranty.

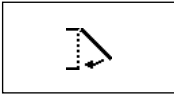
Warning Signals (Red Colour)

Close the service door.



Fill the coffee bean hopper.



The brew group must be inserted into the machine.



Insert the coffee grounds drawer.



Empty the coffee grounds drawer and the coffee residues drawer.



Fill the water tank.

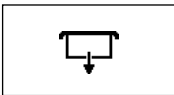

Insert the coffee bean hopper and put the lid back on.

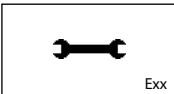

Exx

The machine is out of order. The error code is displayed in the right bottom corner. Turn off the machine. Turn it back on after 30 seconds. Try this 2 or 3 times.

For error codes 1 -3 - 4 - 5, please also refer to the "Troubleshooting" chapter. If the machine does not start, contact the Philips SAECO hotline in your country and quote the error code shown on the display.

Contact details can be found in the warranty booklet packed separately or at www.saeco.com/support.



TROUBLESHOOTING

This chapter summarizes the most common problems you could encounter with your machine. If you are unable to solve the problem with the information below, visit www.saeco.com/support for a list of frequently asked questions or contact the Philips Saeco hotline in your country. Contact details can be found in the warranty booklet packed separately or at www.saeco.com/support.

Machine actions	Causes	Solutions
Error Code 1 Coffee grinder blocked.	Coffee outlet duct clogged.	Thoroughly clean the coffee outlet duct as described in the "Weekly Cleaning of the Brew Group" chapter.
Error Code 3-4 Brew group blocked, cannot be pulled out.	The brew group is out of place.	Close the service door. Turn off and back on the machine. The brew group automatically returns to the initial position.
Error Code 5 Water circuit error.	Air in the water circuit.	Remove and put back the water tank a few times, making sure it is properly reinserted. Check that the water tank compartment is clean. If the Intenza+ filter is installed, remove it. Turn off the machine and put it back on. Thereafter place the filter back.

Machine actions	Causes	Solutions
The machine does not turn on.	The machine is not connected to the electric network.	Connect the machine to the electric network.
	The power button is on position "0".	Check that the power button is set to "I".
The drip tray gets filled although no water is drained.	Water is sometimes drained automatically by the machine into the drip tray to manage the rinsing of the circuits and ensure optimum machine performance.	This is a normal behaviour of the machine.
The red  icon is always displayed on the machine.	The coffee grounds drawer has been emptied with the machine off.	The coffee grounds drawer must always be emptied with the machine on. Wait until the  icon is displayed before refitting the drawer.
Coffee is not hot enough.	The cups are cold.	Preheat the cups with hot water.
	Temperature is not correctly set.	Set the temperature as described in the "Programming" chapter.
	The machine circuit is clogged by limescale.	Descalcify the machine.
No hot water is dispensed.	The water dispensing spout hole is clogged.	Unclog the coffee dispensing spout hole with a pin. Make sure that the machine is off and has cooled down before performing this operation.
Coffee does not have enough crema. (see note)	The blend is unsuitable, coffee is not freshly roasted or the grind is too coarse.	Change coffee blend or adjust grinding as explained in the "Adjusting the Ceramic Coffee Grinder" chapter.
The milk is not frothed.	The milk carafe is dirty or not inserted correctly.	Clean the carafe and insert it correctly.
	The milk carafe dispenser has not been removed correctly.	Check that the milk dispensing spout has been removed correctly.
	The type of milk used is not suitable for frothing.	Use the type of milk suggested in the "Milk Carafe" chapter.
The brew group cannot be removed.	The brew group is out of place.	Turn on the machine. Close the service door. The brew group automatically returns to the initial position.
	The coffee grounds drawer is inserted.	Remove the coffee grounds drawer before removing the brew group.
The brew group cannot be inserted.	The brew group is not in the off position.	Make sure that the brew group is in the off position, as described in the "Weekly Cleaning of the Brew Group" chapter.
	The gearmotor is not in the correct position.	Insert the drip tray and the coffee grounds drawer. Close the service door. Turn on the machine without inserting the brew group. The gearmotor moves back to the correct position. Turn off the machine and reinsert the brew group as described in the "Weekly Cleaning of the Brew Group" chapter.

Machine actions	Causes	Solutions
There is a lot of ground coffee under the brew group.	Coffee is not suitable for automatic machines.	It may be necessary to change the type of coffee or the coffee grinder settings.
The machine grinds coffee beans but no coffee comes out. (see note)	There is no water.	Fill the water tank and prime the circuit (see the "Using the Machine for the First Time" chapter).
	The brew group is dirty.	Clean the brew group (see the "Weekly Cleaning of the Brew Group" chapter).
	This might occur when the machine is automatically adjusting the dose.	Brew some cups of coffee as described in the "Saeco Adapting System" chapter.
	The circuit is not primed.	Prime the circuit (see the "Using the Machine for the First Time" chapter).
	The coffee dispensing spout is dirty.	Clean the coffee dispensing spout.
Coffee is too weak. (see note)	This might occur when the machine is automatically adjusting the dose.	Brew some cups of coffee as described in the "Saeco Adapting System" chapter.
	Coffee is too coarse.	Change coffee blend or adjust grinding as explained in the "Adjusting the Ceramic Coffee Grinder" chapter.
	The coffee bean hopper selector switch has been shifted.	Move the selector switch to the "☰" position.
Coffee is brewed slowly. (see note)	The coffee grind is too fine.	Change coffee blend or adjust grinding as explained in the "Adjusting the Ceramic Coffee Grinder" chapter.
	The circuits are clogged.	Perform a descaling cycle.
	The circuit is not primed.	Prime the circuit (see the "Using the Machine for the First Time" chapter).
	The brew group is dirty.	Clean the brew group (see the "Weekly Cleaning of the Brew Group" chapter).
Coffee leaks out of the coffee dispensing spout.	The coffee dispensing spout is clogged.	Clean the coffee dispensing spout and its holes.
The selector switch is blocked.	Some coffee beans may have got stuck.	Move the selector switch back and forth until the coffee beans are released.
The coffee bean hopper cannot be inserted.	The blade under the coffee bean hopper has been shifted.	Slide the blade up to the end of the guide until the hole is covered.
	There might still be some coffee beans in the coffee compartment.	Remove coffee beans.
	The selector switch is not in the correct position.	Shift the selector switch to the open position "☰".
Coffee does not taste like the new coffee beans.	The coffee outlet duct and grinder have not been emptied.	You need to brew at least two cups of coffee before you can taste the new coffee beans.

Machine actions	Causes	Solutions
The icon  is shown.	The coffee bean hopper selector switch has been shifted.	Move the selector switch to the "  " position.
	The coffee bean hopper and tray are dirty.	Clean the coffee bean hopper and tray to remove any coffee residues. ("Weekly Cleaning of the Coffee Bean Hopper, Tray and Coffee Compartment" chapter)
The machine is in demo mode.	The "  " button was pressed and held for more than 8 seconds.	Disconnect the power cord and turn the machine back on.

**Note:**

These problems can be considered normal if the coffee blend has been changed or if the machine has just been installed. In this case, wait until the machine performs a self-adjusting operation as described in the "Saeco Adapting System" section.

ENERGY SAVING

Stand-by

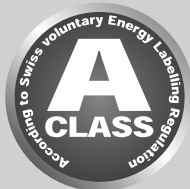

The Saeco fully automatic espresso coffee machine is designed for energy saving, as proven by the Class A energy label.

After 15 minutes of inactivity, the machine turns off automatically (unless a different stand-by time has been programmed). If a product has been brewed, the machine performs a rinse cycle.

In stand-by mode, the energy consumption is below 1Wh.

To turn on the machine, press the “” button (if power button on the back of the machine is set to “I”). If the boiler is cold, the machine performs a rinse cycle.

Disposal



Do not throw away the machine with the normal household waste at the end of its life, but hand it in at an official collection point for recycling. By doing this, you help to preserve the environment.

- Packaging materials can be recycled.
- Machine: unplug the machine and cut the power cord.
- Deliver the appliance and power cord to a service centre or public waste disposal facility.

This product complies with EU Directive 2002/96/EC.

The symbol on the product or on its packaging indicates that this product cannot be treated as household waste. Instead, it shall be handed over to the applicable collection point for the recycling of electrical and electronic equipment.

By ensuring this product is disposed of correctly, you will help prevent potential negative consequences for the environment and human health, which could otherwise be caused by inappropriate waste handling of this product. For more detailed information about recycling this product, please contact your local city office, your household waste disposal service or the shop where you purchased the product.

TECHNICAL SPECIFICATIONS

The manufacturer reserves the right to make changes to the technical specifications of the product.

Nominal Voltage - Power Rating - Power Supply	See data plate on the inside of the service door
Housing material	ABS - Thermoplastic
Size (w x h x d)	256 x 350 x 470 mm
Weight	8.5 kg
Power cord length	800 - 1200 mm
Control panel	Front panel
Cup size	142
Water tank	1.9 litres - Removable type
Coffee bean hopper capacity	300 g
Coffee grounds drawer capacity	14
Pump pressure	15 bar
Boiler	Stainless Steel
Safety devices	Thermal fuse

WARRANTY AND SERVICE

Warranty

For detailed information on your warranty and related conditions, please read the warranty booklet supplied separately.

Service

We want to ensure that you remain satisfied with your machine. If you have not already done so, please register your purchase on **www.saeco.com/welcome**. This will allow us to stay in contact with you and send you cleaning and descaling reminders.

If you need service or support, please visit the Philips website at **www.saeco.com/support** or contact the Philips Saeco hotline in your country. Contact details can be found in the warranty booklet packed separately or at **www.saeco.com/support**.

ORDERING MAINTENANCE PRODUCTS

For cleaning and descaling, use Saeco maintenance products only. You can purchase the products at the Philips online shop at www.shop.philips.com/service, from your local dealer or at authorised service centres.

If you have any difficulties obtaining maintenance products for your machine, please contact the Philips Saeco hotline in your country.

Contact details can be found in the warranty booklet packed separately or at www.saeco.com/support.

Overview of maintenance products



- Descaling solution CA6700



- INTENZA+ Water Filter CA6702



- Grease HD5061

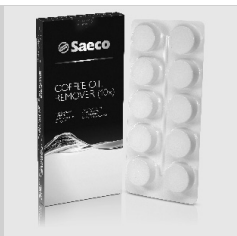

- Coffee Oil Remover CA6704



- Milk Circuit Cleaner CA6705



- Maintenance Kit CA 6706

MACHINE ACCESSORIES

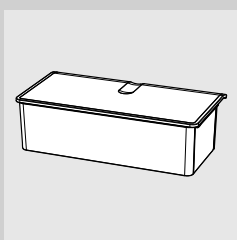

- Removable coffee bean hopper CA6803



The manufacturer reserves the right to make changes without prior notice.

www.philips.com/saeco



421946012471

Rev.00 del 30-06-14