

PHILIPS

AC0817/AC0819
AC0820



EN User manual 3

ZH-HK 用戶手冊 15



Contents

1	Important	4
	Safety	4
2	Your air purifier	6
	Product Overview	6
	Controls overview	7
3	Using the air purifier	7
	Understanding the air quality light	7
	Installing the filter	8
	Connecting power	8
	Turning on and off	8
	Changing the mode setting	9
4	Cleaning	9
	Cleaning schedule	9
	Cleaning the body of the air purifier	10
	Cleaning the air quality sensor	10
	Cleaning the surface of the filter	10
5	Replacing the filter	11
	Understanding the healthy air protect lock	11
	Replacing the filter	11
	Filter reset	12
6	Storage	12
7	Troubleshooting	12
8	Warranty and support	14
	Order parts or accessories	14
9	Notices	14
	Electromagnetic fields (EMF)	14
	Recycling	14

1 Important

Safety

Read this user manual carefully before you use the appliance, and save it for future reference.

Danger

- Do not clean the appliance with water, any other liquid, or a (flammable) detergent to avoid electric shock and/or a fire hazard.
- Do not spray any flammable materials such as insecticides or fragrance around the appliance.

Warning

- Check if the voltage indicated on the appliance corresponds to the local power voltage before you connect the appliance.
- If the power cord is damaged, you must have it replaced by Philips, a service center authorized by Philips, or similarly qualified persons in order to avoid a hazard.
- Do not use the appliance if the adaptor, the power cord, or the appliance itself is damaged.
- Only use the approved 3-pin plug adapter (KA1801A-2400750BS) provided with the appliance.
- This appliance can be used by children aged from 8 years and above and persons with reduced physical, sensory or mental capabilities or lack of experience and knowledge if they have been given supervision or instruction concerning use of the appliance in a safe way and understand the hazards involved. Child shall not play with the appliance. Cleaning and maintenance shall not be made by children without supervision.
- Do not block the air inlet and outlet.
- Do not place any items on top of the air outlet, or in front of the air inlet.
- Make sure that foreign objects do not fall into the appliance through the air outlet.

Caution

- This appliance is not a substitute for proper ventilation, regular vacuum cleaning, or use of an extractor hood or fan while cooking.
- Always place and use the appliance on a dry, stable, level, and horizontal surface.
- Leave at least 20cm free space around the appliance and leave at least 30cm free space above the appliance.
- Do not sit or stand on the appliance. Do not place anything on top of the appliance.
- Do not place the appliance directly below an air conditioner to prevent condensation from dripping onto the appliance.
- Only use the original Philips filters specially intended for this appliance. Do not use any other filters.
- Combustion of the filter may cause irreversible human hazard and/or jeopardize other lives. Do not use the filter as fuel or for similar purpose.
- Avoid knocking against the appliance (the air inlet and outlet in particular) with hard objects.
- Do not insert your fingers or objects into the air outlet or the air inlet to prevent physical injury or malfunctioning of the appliance.
- Do not use this appliance when you have used indoor smoke-type insect repellents or in places with oily residues, burning incense, or chemical fumes.
- Do not use the appliance near gas appliances, heating devices or fireplaces.
- Always turn off the air purifier first, then unplug adapter from wall outlet, when you want to moving, cleaning appliance, replacing the filters or carry out other maintenance.
- The appliance is only intended for household use under normal operating conditions.
- Do not use the appliance in wet surroundings or in surroundings with high ambient temperatures, such as the bathroom, toilet, or kitchen, or in a room with major temperature changes.
- The appliance does not remove carbon monoxide (CO) or radon (Rn). It cannot be used as a safety device in case of accidents with combustion processes and hazardous chemicals.

2 Your air purifier

Congratulations on your purchase, and welcome to Philips!

To fully benefit from the support that Philips offers, register your product at www.philips.com/welcome.

Product Overview

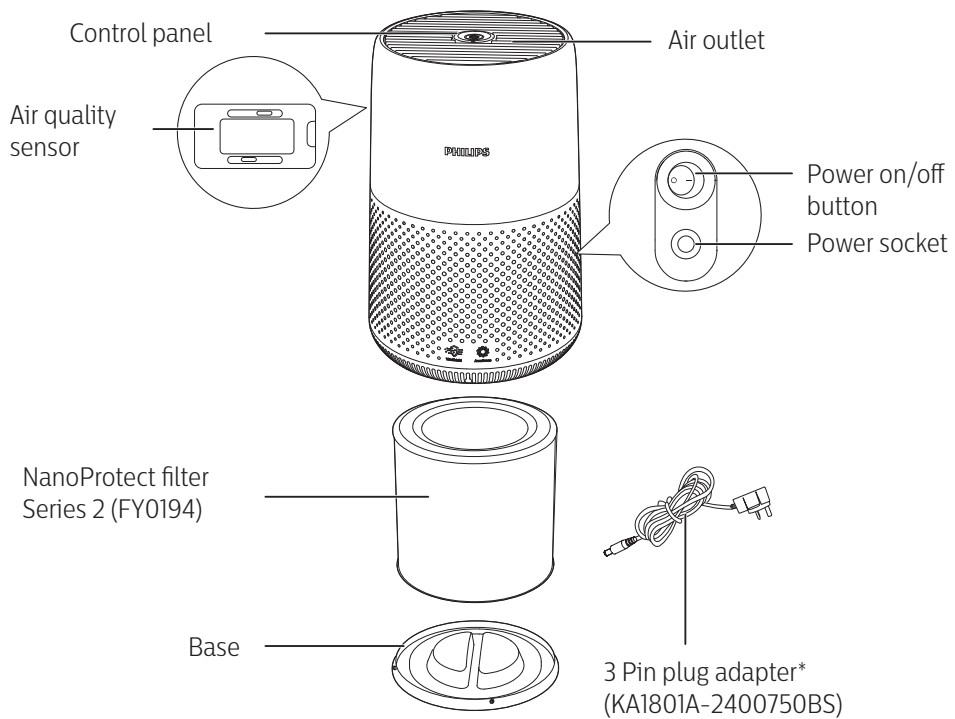

*Please use only the 3 pin plug adapter provided.

Controls overview

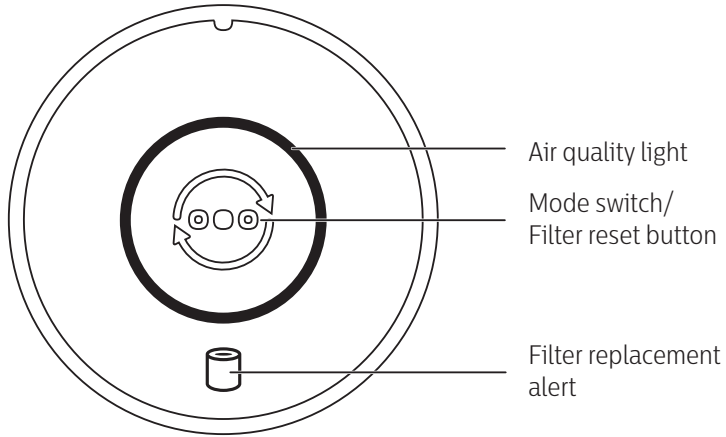

3 Using the air purifier

Understanding the air quality light

The color of air quality light corresponds to the ambient air quality.
The brightness of air quality light reflects the current running mode.

PM2.5 level	Air quality light color	Air quality level
≤12	Blue	Good
13-35	Blue-purple	Fair
36-55	Purple-red	Poor
>55	Red	Very poor

Installing the filter

Remove all packaging of the filter before use.

Note: Make sure the air purifier is unplugged from the electrical outlet before installing the filter.

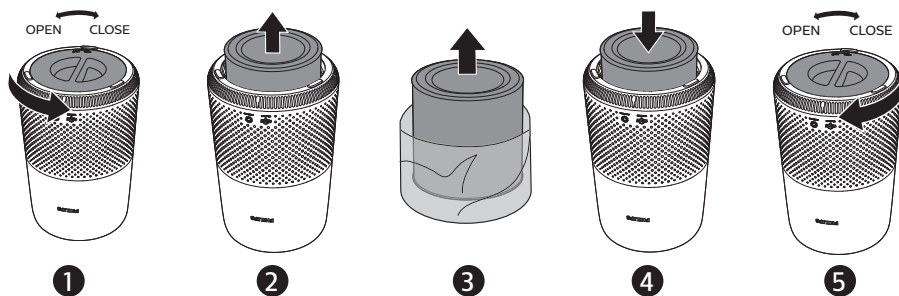

- 1 Rotate the base anti-clockwise to remove it from the appliance.
- 2 Pull the filter out from the appliance.
- 3 Remove all packaging materials of the air purification filter.
- 4 Put the filter back into the appliance.
- 5 Reattach the base and rotate it clockwise to fasten the base.

Connecting power

Note: Risk of electric shock! When you unplug the AC power cord, always pull the plug from the socket. Never pull the cord.

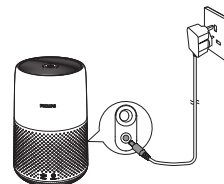

Connect the power adapter to:

- First, the power socket on the appliance.
- Then, the wall outlet.



Turning on and off

Note:

- For optimum purification performance, close doors and windows.
- 1 Press the power button  on the back of the air purifier to switch on.
 - ↳ The air purifier operates in the auto mode by default.
 - 2 Press the power  button again to switch off the air purifier.

Changing the mode setting

You can choose Auto mode, Turbo mode or the Sleep mode by pressing the mode switch button . The brightness of air quality light reflects the current running mode:

- Sleep mode-lowest brightness
- Auto mode-mid level brightness
- Turbo mode-highest level brightness

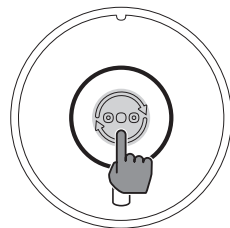

Auto mode

In Auto mode, the appliance selects the fan speed in accordance with the ambient air quality.

Turbo mode

In Turbo mode, the air purifier operates on the highest speed.

Sleep mode

In Sleep mode, the air purifier operates quietly at a low speed.

4 Cleaning

Note:

- Never use abrasive, aggressive, or flammable cleaning agents such as bleach or alcohol to clean any part of the appliance.

Cleaning schedule

Frequency	Cleaning method
When necessary	Wipe the surface of the appliance with a soft dry cloth
	Clean the air outlet cover
Every two months	Clean the air quality sensor with a dry cotton swab
Every four weeks	Clean the surface of the filter

Cleaning the body of the air purifier

Regularly clean the inside and outside of the air purifier to prevent dust from collecting.

- 1 Use a soft, dry cloth to clean both the interior and exterior of the air purifier.
- 2 The air outlet can also be cleaned with a dry, soft cloth.

Cleaning the air quality sensor

Clean the air quality sensor every two months for optimal functioning of the appliance.

Note:

- If the air purifier is used in a dusty environment, it may need to be cleaned more often.
- If the humidity level in the room is very high, condensation may develop on the air quality sensor and the air quality light may indicate a poorer air quality even though the air quality is actually good. If this occurs, clean the air quality sensor or use the air purifier on a manual speed setting.

- 1 Switch off the air purifier and unplug from the power socket.

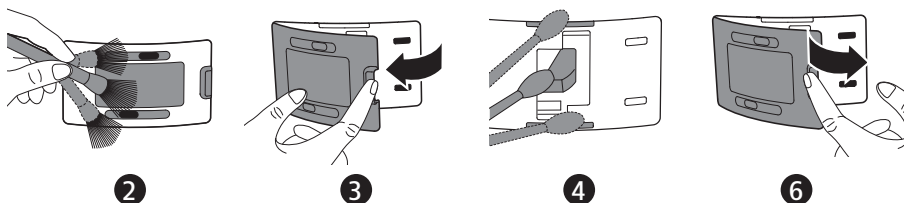

- 2 Clean the inlet and outlet of the air quality sensor with a soft brush.
- 3 Open the air quality sensor cover.
- 4 Clean the air quality sensor, the dust inlet and the dust outlet with a damp cotton swab.
- 5 Dry all parts thoroughly with a dry cotton swab.
- 6 Reattach the air quality sensor cover.

Cleaning the surface of the filter

Wipe the surface of the filter with soft wet cloth or clean the surface of the filter with a vacuum cleaner.

Note:

- if you use a high power/ industrial vacuum cleaner, it may damage the filter.

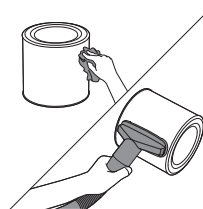

5 Replacing the filter

Understanding the healthy air protect lock

This appliance is equipped with the healthy air protect lock to make sure that the NanoProtect filter is in optimal condition when the appliance is operating. When the filter is almost expired, the filter replacement alert (🗑️) lights up red, which indicates that it needs to be replaced. If you do not replace the filter in time, the filter replacement alert (🗑️) will flash. The appliance will stop operating and get locked.

Replacing the filter

Note:

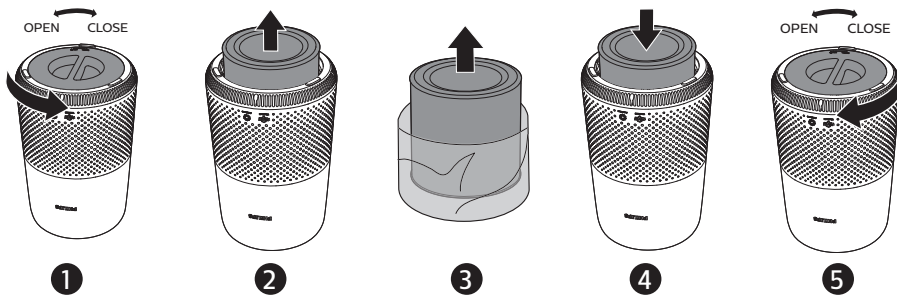

- The filter is not washable or reusable.
- Always turn off the air purifier and unplug from the electrical outlet before replacing the filter.



- 1 Rotate the base anti-clockwise to remove it from the appliance.
- 2 Pull the filter out from the appliance. Discard the used filter.
- 3 Remove all packaging materials of the new filter.
- 4 Put the filter into the appliance.
- 5 Reattach the base and rotate it clockwise to fasten the base.
- 6 Put the plug of the air purifier in the power socket.
- 7 Press the power (🔌) button to switch on the appliance.
- 8 Press and hold (🗑️) for 3 seconds to reset the filter lifetime counter.
- 9 Wash your hands thoroughly after replacing the filter.

Filter reset

You can replace the filter even before filter replacement alert () displays on the screen. After replacing a filter, you need to reset the filter lifetime counter manually.

- 1 Press the power button () to turn on the appliance.
- 2 Within 10 seconds after power on, press and hold the mode switch button () for 5 seconds to reset the filter lifetime counter.



6 Storage

- 1 Turn off the air purifier and unplug from the power socket.
- 2 Clean the air purifier, air quality sensor and the surface of the filter (see the chapter “Cleaning”).
- 3 Let all parts air dry thoroughly before storing.
- 4 Wrap the filter in air tight plastic bags.
- 5 Store the air purifier, filter in a cool, dry location.
- 6 Always thoroughly wash hands after handling a filter.

7 Troubleshooting

This chapter summarizes the most common problems you could encounter with the appliance. If you are unable to solve the problem with the information below, contact the Consumer Care Center in your country.

Problem	Possible solution
The appliance does not work even though it is plugged in.	<ul style="list-style-type: none">• The filter replacement alert is on but you have not replaced the corresponding filter. As a result, the appliance is now locked. In this case, replace the filter and reset the filter lifetime counter.
The airflow that comes out of the air outlet is significantly weaker than before.	<ul style="list-style-type: none">• The surface of the filter is dirty. Clean the surface of the filter (see the chapter “Cleaning”).

Problem	Possible solution
The air quality does not improve, even though the appliance has been operating for a long time.	<ul style="list-style-type: none"> • Check if the packing material is removed from the filter. • Make sure that the filter is properly installed. • The air quality sensor is dirty or wet. Clean the air quality sensor (See the chapter “Cleaning”). • Room size is large or the outdoor air quality is poor. For optimum purification performance, please close the doors and windows when operating the air purifier. • There are indoor pollution resources. For instances, smoking, cooking, incense. • Filter reaches the end of life. Replace the filter with a new one.
The appliance produces a strange smell.	<ul style="list-style-type: none"> • The first few times you use the appliance, it may produce a plastic smell. This is normal. However, if the appliance produces a burnt smell even if removing the filter, contact your Philips dealer or an authorized Philips service center. The filter may produce smell after being used for a while because of the absorption of indoor gases. It's recommended that you reactivate the filter by putting it in direct sunlight for repeated use. If odor still exists, replace the filter.
The appliance is extra loud.	<ul style="list-style-type: none"> • Check if the packing of the filter is removed. • The appliance will run in high speed when the air quality is poor, which will causes higher noises. When using the appliance in a bedroom at night, choose the Sleep speed. • if anything drops into air outlet, it may also cause abnormal loud sounds. Immediate turn off appliance, turn appliance upside down, to get foreign objectives out of appliance.
The appliance still indicates that I need to replace a filter, but I already did.	<ul style="list-style-type: none"> • Perhaps you did not reset the filter lifetime counter. Switch on the appliance. Then press and hold the mode switch button () for 3 seconds until  disappears.
Appliance keeps off, but air quality light blinks for one minute.	<ul style="list-style-type: none"> • The appliance has malfunctions. Contact the Consumer Care Center in your country.

8 Warranty and support

Versuni offers a two-year warranty after purchase on this product. This warranty is not valid if a defect is due to incorrect use or poor maintenance. Our warranty does not affect your rights under law as a consumer. For more information or for invoking the warranty, please visit our website www.philips.com/support.

Order parts or accessories

If you have to replace a part or want to purchase an additional part, go to your Philips dealer or visit www.philips.com/support.

If you have problems obtaining the parts, please contact the Philips Consumer Care Center in your country.

9 Notices

Electromagnetic fields (EMF)

This appliance complies with the applicable standards and regulations regarding exposure to electromagnetic fields.

Recycling

Do not throw away the product with the normal household waste at the end of its life, but hand it in at an official collection point for recycling. By doing this, you help to preserve the environment.

Follow your country's rules for the separate collection of electrical and electronic products. Correct disposal helps prevent negative consequences for the environment and human health.

目錄

1	重要事項	16
	安全	16
2	您的空氣清新機	18
	產品概要	18
	控制鍵概覽	19
3	使用空氣清新機	19
	了解空氣質素指示燈	19
	安裝濾網	20
	連接電源	20
	開關	20
	更改模式設定	21
4	清潔	21
	清潔時間表	21
	清潔空氣清新機機身	21
	清潔空氣質素感應器	22
	清潔濾網表面	22
5	更換濾網	23
	了解清新空氣保護鎖	23
	更換濾網	23
	重設濾網	23
6	儲存	24
7	疑難排解	24
8	保固與支援	25
	訂購零件或配件	25
9	注意	26
	電磁場 (EMF)	26
	回收	26

1 重要事項

安全

使用本產品前請先閱讀本用戶手冊，並保管以作將來參考。

危險事項

- 請勿用水或任何液體或（易燃）清潔劑清潔此產品，以避免觸電和/或火災的危險。
- 請勿在本產品周圍噴射殺蟲劑或芳香劑等易燃物品。

警告

- 在連接本產品前，請檢查產品註明的指示電壓與當地電源電壓是否對應。
- 如果電源線損壞，為避免危險，必須由 Philips、Philips 授權的維修中心或類似的合資格人士來更換。
- 若轉接器、電源線或產品本身已受損，請勿使用。
- 僅使用隨產品提供的經認可 3 腳插頭變壓器 (KA1801A-2400750BS)。
- 此產品可供八歲及以上兒童，體能、感官或心智能力低下人仕，或缺乏知識及經驗人仕使用，如該等人仕已就使用本產品給予監督或有關安全使用本產品的指導及明白本產品的使用所涉及的危險。請勿讓孩童將本產品當成玩具。兒童不應於沒有監督情況下對產品進行清潔及維護。
- 不要阻塞進氣口或排氣口。
- 請勿將任何物品放在排氣口頂部或進氣口前面。
- 確保異物不會通過排氣口掉入裝置內部。

注意

- 本產品並不是適當通風設備、正規吸塵器或煮食時使用的抽油煙機或風扇的替代品。
- 在乾燥、穩定、平滑和水平表面上使用產品。
- 在本產品的周圍至少留出 20 厘米的空間，本產品上方至少留出 30 厘米空間。
- 請勿坐或站立在裝置上。請勿在裝置上放置任何物品。

- 請勿在冷氣機正下方放置產品，以避免冷凝滴水到產品上。
- 僅使用本產品專用的原裝 Philips 濾網。請勿使用任何其他濾網。
- 燃燒濾網可能造成對健康無可挽回的傷害及/或危及他人生命。不要使用濾網作為燃料或類似用途。
- 避免以硬物碰撞產品（尤其是產品的進氣口或排氣口）。
- 請勿將您的手指或其他物件放入進氣口或排氣口，以免造成身體傷害或產品故障。
- 若您使用室內煙型驅蚊劑，或該地方有油跡、香火或化學煙霧，請勿使用本產品。
- 請勿在煤氣用具、暖氣設備或壁爐旁邊使用本產品。
- 當移動及清潔產品、更換濾網或進行其他維修保養時，請務必先關閉空氣清新機，然後從牆上插座拔下變壓器。
- 本產品只適合一般操作環境下的家居使用。
- 請勿在洗手間或廚房等濕潤或高溫環境，或溫度變化較大的房間使用本產品。
- 本產品不會去除一氧化碳 (CO) 或氫 (Rn)。本產品不能在含有燃燒過程和危險化學品的意外中充當安全裝置。

2 您的空氣清新機

感謝您購買 Philips 產品，歡迎來到 Philips 世界！

請前往以下網址註冊您的產品，以獲得 Philips 的完整支援：

www.philips.com/welcome。

產品概要

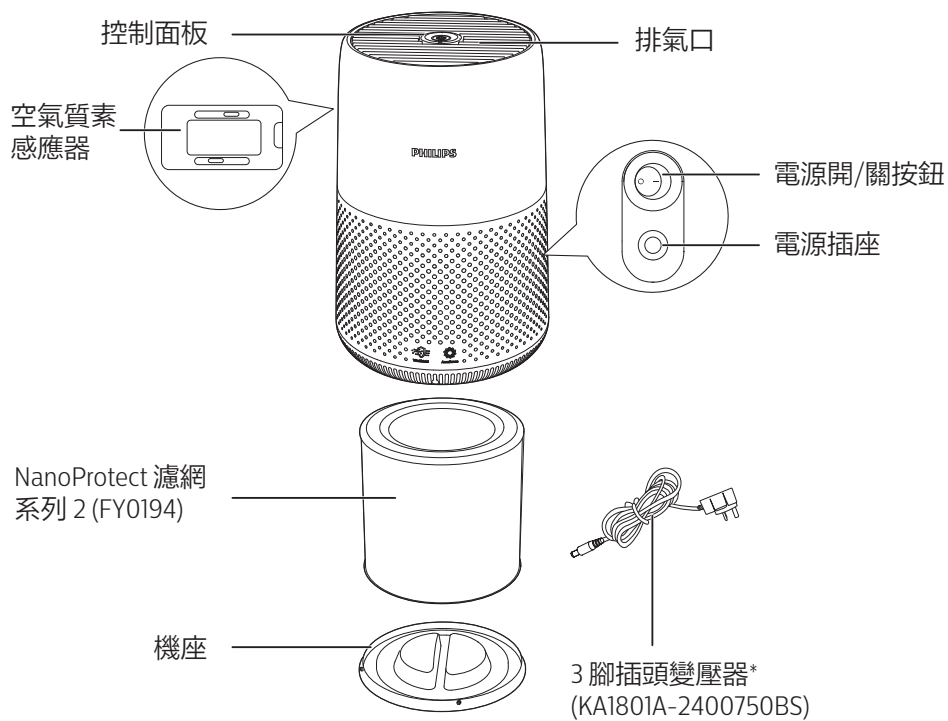

*請使用提供的3腳插頭變壓器。

控制鍵概覽

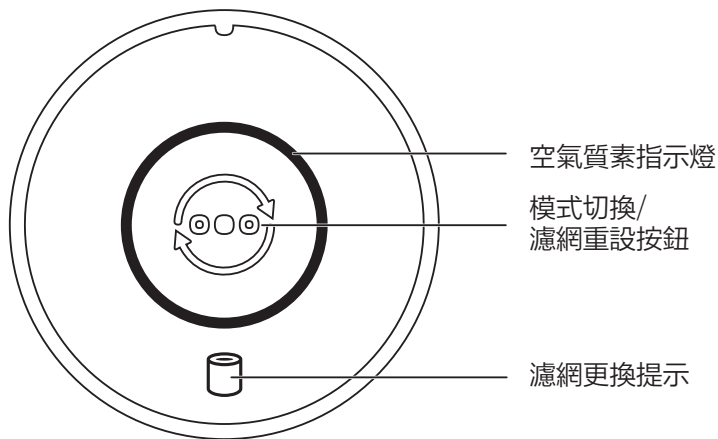

3 使用空氣清新機

了解空氣質素指示燈

空氣質素指示燈的顏色與空氣質素環境對應。

空氣質素指示燈的亮度反映現時的運行模式。

PM2.5 水平	空氣質素指示燈的顏色	空氣質素水平
≤12	藍色	良好
13-35	藍色-紫色	一般
36-55	紫色-紅色	差
>55	紅色	非常差

安裝濾網

使用前，請移除濾網的所有包裝。

備註：安裝濾網前，請確保空氣清新機已經從電源插座拔除。

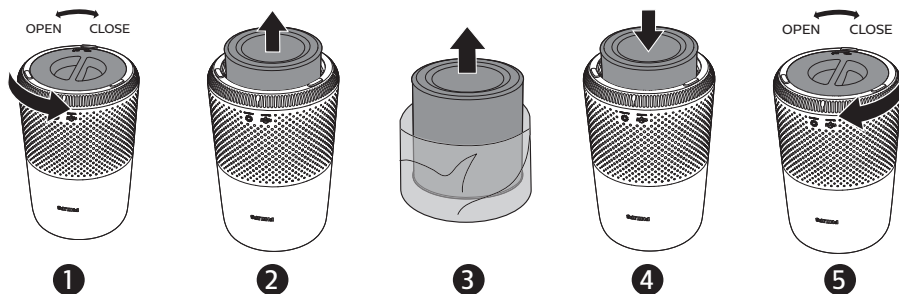

- 1 以逆時針方向旋轉機座，將其從產品中取出。
- 2 由本產品拉出濾網。
- 3 移除空氣淨化濾網的所有包裝物料。
- 4 將濾網裝回本產品。
- 5 重新連接機座，並以順時針方向旋轉以扭緊機座。

連接電源

備註：有觸電危險。拔除 AC 電源線時，請務必將插頭從插座拔下。請勿拉扯電源線。

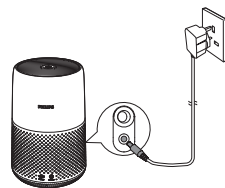

連接電源變壓器至：

- 首先，連接至產品上的電源插座。
- 然後，連接至牆上的電源插座。



開關

備註：

- 請關閉門窗，以獲得最佳的空氣淨化效果。
- 1 按背面的電源按鈕  開啟空氣清新機。
 - ↳ 空氣清新機以預設的自動模式運行。
 - 2 再按一次電源  按鈕關閉空氣清新機。

更改模式設定

可按模式切換按鈕選擇自動模式、特強模式或睡眠模式 。空氣質素指示燈的亮度反映現時的運行模式：

- 睡眠模式-最暗亮度
- 自動模式-中等亮度
- 特強模式-最光亮度

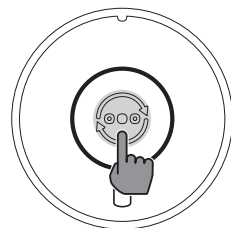

自動模式

在自動模式下，本產品會根據空氣質素環境選擇風扇速度。

特強模式

在特強模式中，空氣清新機以最高速度運作。

睡眠模式

在睡眠模式中，空氣清新機會以緩慢速度安靜運作。

4 清潔

備註：

- 請勿使用磨蝕性、侵略性或易燃清潔劑（如漂白劑或酒精）清洗本產品的任何一部分。

清潔時間表

頻率	清潔方法
必要時	用柔軟的乾布抹乾淨本產品表面
	清潔排氣口護蓋
每兩個月	使用乾棉花棒清潔空氣質素感應器
每四週	清潔濾網表面

清潔空氣清新機機身

請定時清潔本空氣清新機的內部和外部，以避免積聚塵埃。

- 1 使用柔軟乾爽的抹布清潔空氣清新機的內部和外部。
- 2 排氣口亦可以柔軟乾爽的抹布清潔。

清潔空氣質素感應器

每 2 個月清潔一次空氣質素感應器，讓本產品發揮出最佳功能。

備註：

- 如在多塵的環境內使用空氣清新機，則可能需要更常清潔。
- 如房間濕度非常高，水滴便會凝結在空氣質素感應器上，即使實際空氣質素良好，空氣質素指示燈仍可能會顯示較差的空氣質素。在此情況下，請清潔空氣質素感應器或以手動設定空氣清新機的速度。

1 關閉空氣淨化器，並將其從電源插座拔出。

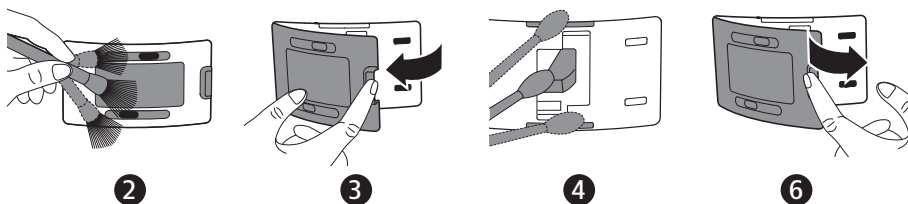

- 2 使用柔軟毛刷清潔空氣質素感應器的出入口。
- 3 打開空氣質素感應器護蓋。
- 4 使用稍為濕潤的棉花棒清潔空氣質素感應器和塵埃的出入口。
- 5 使用乾爽的棉花棒徹底擦乾所有部件。
- 6 重新裝上空氣質素感測器護蓋。

清潔濾網表面

使用柔軟的濕布擦拭濾網表面，或用吸塵機清潔濾網表面。

備註：

- 如果使用高功率/工業用吸塵機，可能會損壞濾網。

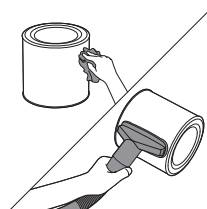

5 更換濾網

了解清新空氣保護鎖

本產品配備清新空氣保護鎖，確保 NanoProtect 濾網在本產品運作中保持最佳狀態。當濾網快將到期時，濾網更換提示 () 燈會亮起紅燈，表示需要更換濾網。如果沒有及時更換濾網，濾網更換提示 () 會閃動。產品將停止操作並會鎖上。

更換濾網

備註：

- 請勿清洗或重用濾網。
- 更換濾網前，必須關閉空氣清新機，並將插頭從電源插座拔出。

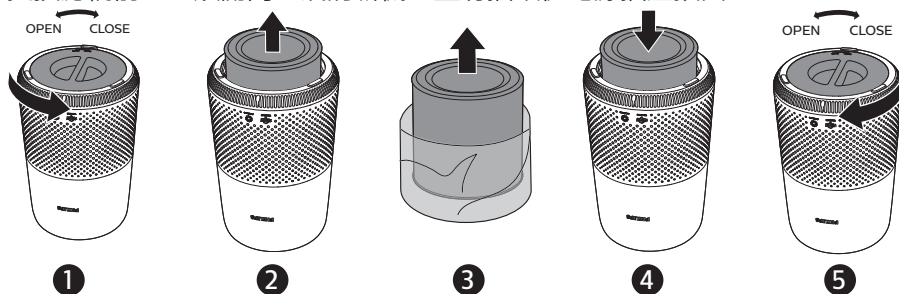

- 1 以逆時針方向旋轉機座，將其從產品中取出。
- 2 由本產品拉出濾網。棄置用過的濾網。
- 3 拆去新的濾網上的所有包裝物料。
- 4 將濾網裝回本產品。
- 5 重新連接機座，並以順時針方向旋轉以扭緊機座。
- 6 將空氣清新機的插頭插入電源插座。
- 7 按電源 () 按鈕以開啟本產品。
- 8 按住 () 3 秒，以重新設定濾網壽命計算器。
- 9 更換濾網後，必須徹底洗淨雙手。

重設濾網

您可以在屏幕顯示濾網更換提示 () 之前更換濾網。更換濾網後，您需要手動重設濾網壽命計算器。

- 1 按電源 () 按鈕以開啟本產品。
- 2 開啟電源後 10 秒內，按住模式切換按鈕 () 5 秒，以重設濾網壽命計算器。

6 儲存

- 1 關閉空氣清新機，並將插頭從牆身插座拔出。
- 2 清潔空氣清新機、空氣質素感應器和濾網表面（請參閱「清潔」章節）。
- 3 必須讓所有部件風乾方可存放。
- 4 將濾網放入密封膠袋中。
- 5 將空氣清新機、濾網存放於陰涼乾爽的地方。
- 6 處理濾網後，必須徹底洗淨雙手。

7 疑難排解

本章節總結一些您在本產品上最常見的問題。如果您按照以下資料仍未能解決問題，請聯絡您的國家的 Philips 顧客服務中心。

問題	可行解決方案
產品即使插上電源也沒有正常運作。	<ul style="list-style-type: none">• 濾網更換提示已亮起但您沒有更換相應濾網。因此本產品已被鎖定。在這情況，請更換該濾網並重設濾網使用時間。
排氣口排出的風量比以前明顯減弱。	<ul style="list-style-type: none">• 濾網的表面骯髒。清潔濾網表面（請查看「清潔」一章）。
本產品經過長時間運作，空氣質素仍沒有改善。	<ul style="list-style-type: none">• 請檢查是否已移除濾網的所有包裝物料。• 確保正確安裝濾網。• 空氣質素感應器骯髒或濕的。清潔空氣質素感應器（請參閱「清潔」一章）。• 房間面積大或室外空氣質素差。為獲得最佳淨化性能，請在操作空氣清新機時關閉門窗。• 有室內污染源頭。例如，吸煙、烹飪、焚香。• 濾網的使用壽命結束。更換全新的濾網。
本產品發出一陣怪味。	<ul style="list-style-type: none">• 在您最初數次使用本產品時，它可能會發出一點塑膠氣味。此為正常。可是，如果本產品在更換濾網後發出燒焦的氣味，請聯絡您的 Philips 經銷商或認可的 Philips 服務中心。由於吸收了室內氣體，濾網使用一段時間後可能會產生氣味。建議您將濾網置於陽光下晾曬，然後再重新使用。如果仍有異味，請更換濾網。

問題	可行解決方案
本產品聲浪太大。	<ul style="list-style-type: none"> 請檢查是否已取出濾網的包裝材料。 當空氣質素差時，產品將以高速運行，因而產生更大的噪聲。如晚上在睡房使用裝置，選擇睡眠速度。 如果有任何東西掉入排氣口，亦有可能產生異常響亮的聲音。立即關閉產品，並倒轉產品，以便從產品中取出外來物體。
即使我已替換濾網，本產品仍表示需要替換。	<ul style="list-style-type: none"> 可能您沒有重設濾網的使用時間。開啟本產品然後按住模式切換按鈕 (⊙) 3 秒直至  消失。
保持產品關閉，但空氣質素燈閃爍一分鐘。	<ul style="list-style-type: none"> 裝置發生故障。請聯絡您所在國家/地區的客戶服務中心。

8 保固與支援

Versuni 為這款產品提供購買後兩年保養。此保養不適用於因不正確使用或維護不良而造成的損壞。我們的保養不會影響您作為消費者的法律權利。有關啟動保養的詳情，請瀏覽我們的網站：www.philips.com/support。

訂購零件或配件

如果您需要更換零件或想訂購額外配件，請前往您的 Philips 經銷商或瀏覽 www.philips.com/support。

如果您索取有關零件時遇上問題，請聯絡您的國家/地區 Philips 客戶服務中心。

9 注意

電磁場 (EMF)

這款產品符合有關電磁場暴露的適用安全標準及條例。

回收

請勿在本產品使用壽命結束後當作一般家庭垃圾廢棄，應交給官方回收站或循環再用。這樣做有助保護環境。

請遵守您的國家/地區回收電器和電子產品的法則。正確處理有助避免對環境和人體造成負面影響。





PHILIPS and the Philips Shield Emblem are registered trademarks of Koninklijke Philips N.V. and are used under license.

This product has been manufactured by and is sold under the responsibility of Versuni Holding B.V., and Versuni Holding B.V. is the warrantor in relation to this product.

2023 © Versuni Holding B.V.

3000.103.2580.1 (20/04/2023)

