



User Manual



©2018 Koninklijke Philips N.V. All rights reserved. HD3070, HD3071, UM, HK, V1.0



English Important

Read this important information leaflet carefully before you use the rice cooker and save it for future reference.

Danger

The appliance must not be immersed.

Warning

This appliance is not intended for use by persons (including children) with reduced physical sensory or

mental capabilities, or lack of experience and knowledge, unless they have been given supervision or instruction concerning use of the appliance by a person responsible for their safety.

Children should be supervised to ensure that they do not play with the appliance. This appliance should be positioned in a stable situation with the handles (if any) positioned to avoid spillage of the hot liquids.

This appliance is intended to be used in household and similar applications such as:

- staff kitchen areas in shops, offices and other working environments;
 - farm houses;
 - by clients in hotels, motels and other residential type environments;
 - bed and breakfast type environments.
- Make sure that the damaged power cord is replaced by Philips, a service center authorized by Philips or similarly qualified persons in order to avoid a hazard.

The appliance is not intended to be operated by means of an external timer or a separate remote-control system.

Surface of the heating element is subject to residual heat after use.

WARNING: Make sure to avoid spillage on the power connector to avoid a potential hazard.

WARNING: Always follow the instructions and use the appliance properly to avoid potential injury.

Check if the voltage indicated on the appliance corresponds to the local power voltage before you connect it.

Only connect the appliance to a grounded power outlet. Always make sure that the plug is inserted firmly into the power outlet.

Do not use the appliance if the plug, the power cord, the inner pot, the sealing ring, or the main body is damaged.

Do not let the power cord hang over the edge of the table or worktop on which the appliance stands.

Make sure the heating element, the temperature sensor, and the outside of the inner pot are clean and dry before you put the plug in the power outlet.

Do not plug in the appliance or press any of the buttons on the control panel with wet hands.

Caution

Never use any accessories or parts from other manufacturers or that Philips does not specifically recommend. If you use such accessories or parts, your guarantee becomes invalid.

Do not expose the appliance to high temperatures, nor place it on a working or still hot stove or cooker.

Do not expose the appliance to direct sunlight.

Place the appliance on a stable, horizontal, and level surface.

Always put the inner pot in the appliance before you put the plug in the power outlet and switch it on.

Do not place the inner pot directly over an open fire to cook rice.

Do not use the inner pot if it is deformed.

The accessible surfaces may become hot when the appliance is operating. Take extra caution when touching the appliance.

Beware of hot steam coming out of the steam vent during cooking or out of the appliance when you open the lid. Keep hands and face away from the appliance to avoid the steam.

Do not lift and move the appliance while it is operating.

Do not exceed the maximum water level indicated in the inner pot to prevent overflow which might cause potential hazard.

Do not place the cooking utensils inside the pot while cooking, keeping warm or reheating rice.

Only use the cooking utensils provided. Avoid using sharp utensils.

To avoid scratches, it is not recommended to cook ingredients with crustaceans and shellfish. Remove the hard shells before cooking.

Do not insert metallic objects or alien substances into the steam vent.

Do not place a magnetic substance on the lid. Do not use the appliance near a magnetic substance.

Always let the appliance cool down before you clean or move it.

Always clean the appliance after use. Do not clean the appliance in a dishwasher.

Always unplug the appliance if not used for a longer period.

If the appliance is used improperly or for professional or semiprofessional purposes, or if it is not used according to the instructions in this user manual, the guarantee becomes invalid and Philips refuses liability for any damage caused.

Electromagnetic fields (EMF)
This Philips appliance complies with all applicable standards and regulations regarding exposure to electromagnetic fields.

繁體中文

重要事項
使用電飯煲前，請先閱讀本重要資訊手冊，並妥善保管以供日後參考。

危險事項

本產品不得浸水。

警告
本產品並不適合身體感覺或心智能力低下人士（包括兒童），或缺乏知識及經驗人士使用，除非該人士已接受其他負責其安全

之人仕就使用本產品的監督或指導。

兒童應受監督以確保他們不會以本產品玩耍。

本產品應置於固定位置，把手應移至合適方向（如有），以防止灼熱液體濺出。

此產品適用於家居及類似的場所，譬如：

- 店舖、辦公室和其他工作環境的員工廚房；
- 農舍；
- 供酒店、汽車旅館或其他居住環境中的住客使用；
- 給提供住宿加早餐的旅館使用。

確保受損的電源線由 Philips、Philips 認可的服務中心或同樣受認可人士更換，以免產生危險。

本電器不得以外部計時器或其他遙控系統操作使用。

加熱元件表面可能會在使用過後尚有餘熱。

警告：請避免電源適配器洩漏，避免發生危險事故。

警告：請遵循此說明並適當地使用本產品，避免發生潛在傷害。

在連接本產品前，請檢查產品註明的指示電壓與當地電壓電壓是否對應。

僅將本產品連接上接地的電源插座。務必確保插頭已穩固插入電源插座。

如插頭、電源線、內鍋、密封圈或機身受損，切勿使用本產品。

請勿讓電源線懸掛於放置在本產品的桌面或工作檯邊緣。

將插頭插入電源插座前，確保加熱元件、溫度感應器及內鍋外部清潔乾爽。

請勿用濕手插入本產品的電源，或按下控制面板的按鈕。

注意

- 請勿使用任何其他廠商製造而非 Philips 特別建議使用的配件或零件。如使用該等配件或零件，您的保障將會失效。
- 請勿將產品暴露於高溫之中，也不要放置於正在使用或仍然發熱的爐子或廚具上。
- 請勿將產品暴露於直射陽光下。
- 將產品放置於穩固、平坦的水平表面上。
- 將插頭插入電源插座並開啟之前，務必將內鍋放入電壓鍋裡。
- 請勿將內鍋直接放置在開放火源上煮飯。
- 如內鍋變形，則請勿使用。
- 產品運作期間，可接觸的表面或會變熱。接觸本產品時必須格外小心。
- 烹調期間，應留意蒸氣通氣孔噴出的熱蒸氣；開蓋時，亦應留意本產品噴出的熱蒸氣。將雙手及臉部遠離本產品，以免受蒸氣燙傷。
- 產品運作時，請勿將其抬起或移動。

請勿超出內鍋內部註明的最高水位，以防止液體溢出，避免發生危險事故。

烹調、保暖或翻熱米飯期間，請勿將廚具放入鍋內。僅使用隨附的廚具。避免使用尖銳的廚具。

為了避免刮花，不建議連同甲殼類或貝類烹調材料。烹調前取下硬殼。

請勿將金屬物件或異物插入蒸氣通氣孔。

請勿將磁性物質放在蓋上。請勿在磁性物質附近使用本產品。

清潔或移動本產品之前，務必讓本產品冷卻下來。

使用後請清潔本產品。請勿將本產品放入洗碗機內清洗。

如長時間不使用本產品，務必拔除本產品的插頭。如不當使用本產品、使用本產品作專業或半專業用途，或沒有按照本用戶手冊的說明使用本產品，保用將會失效，而 Philips 亦拒絕承擔任何造成的損毀。

電磁場 (EMF)
這款 Philips 產品符合一切有關電磁場暴露的適用安全標準及條例。

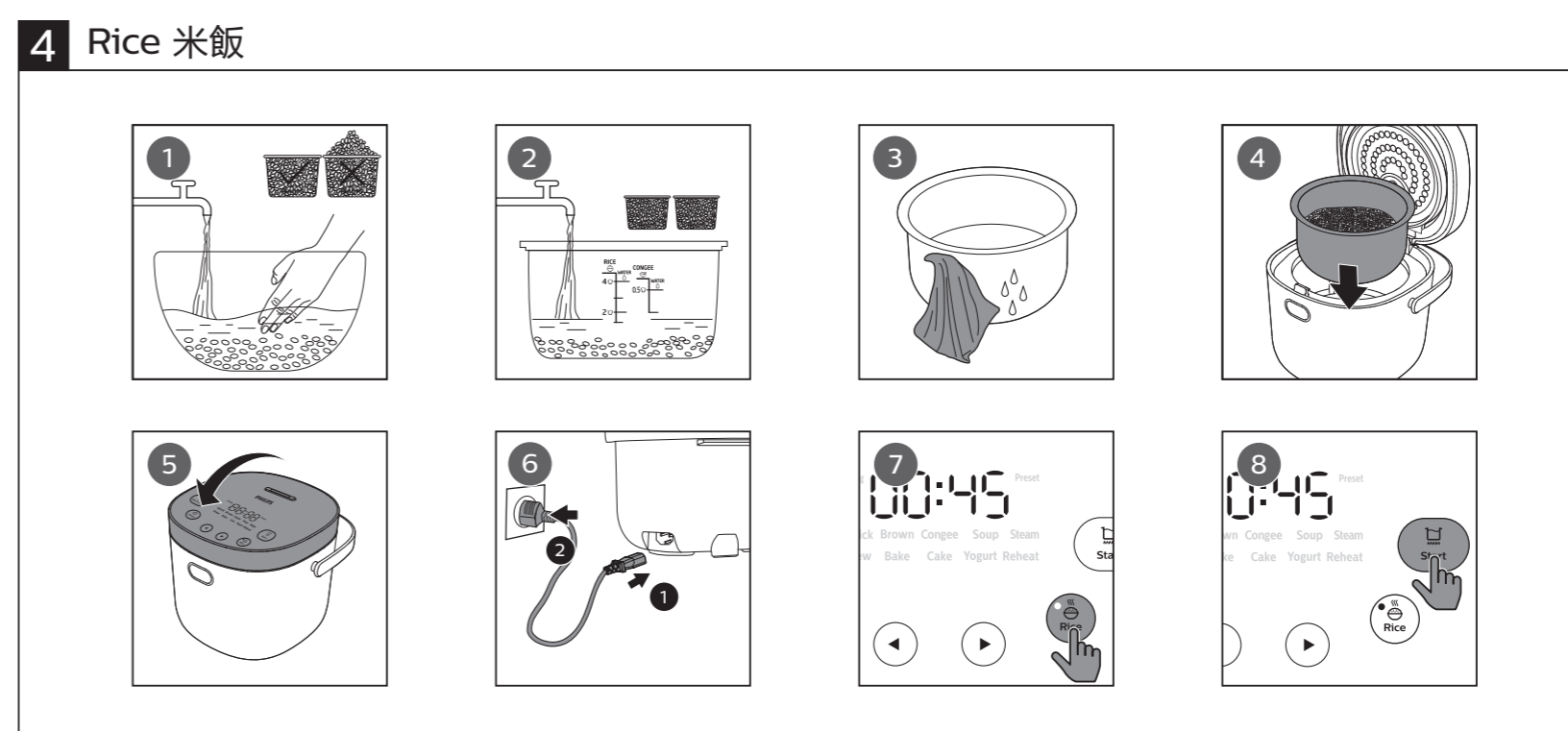
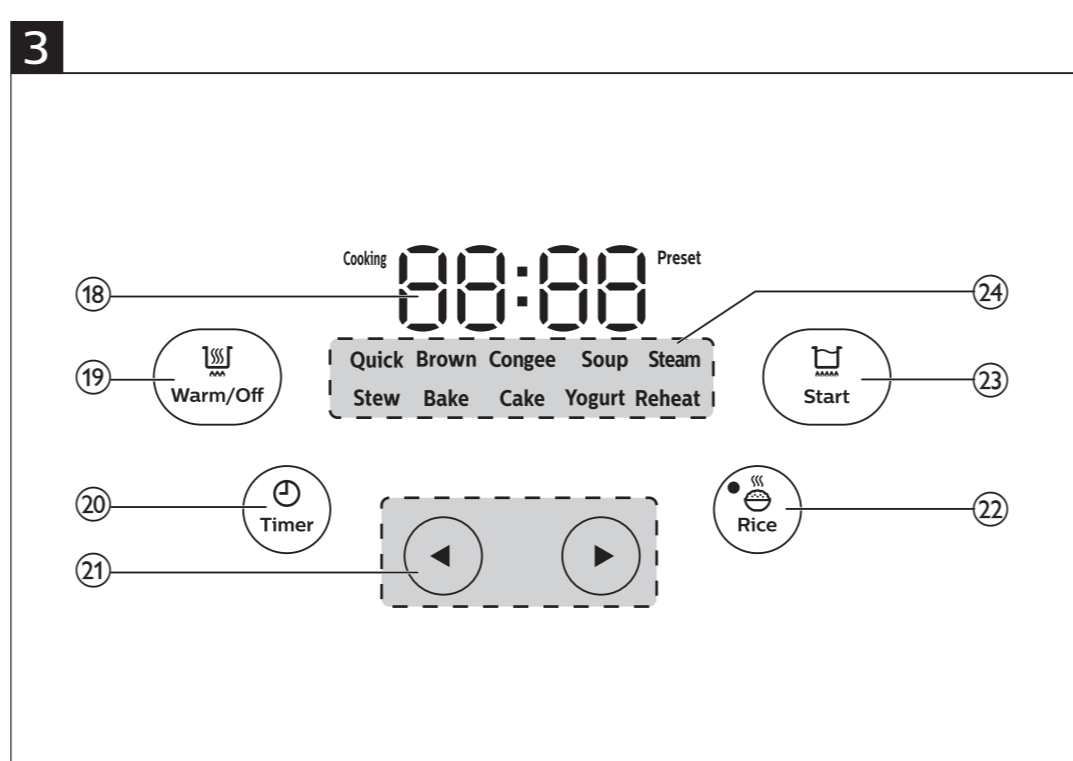
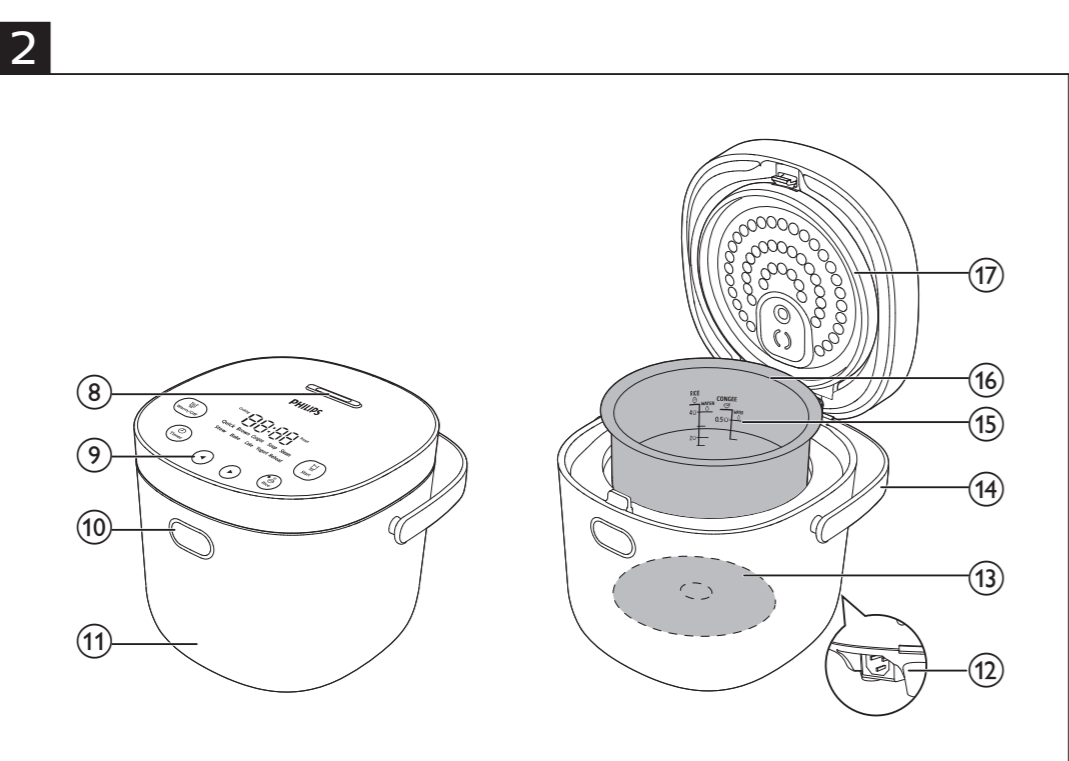
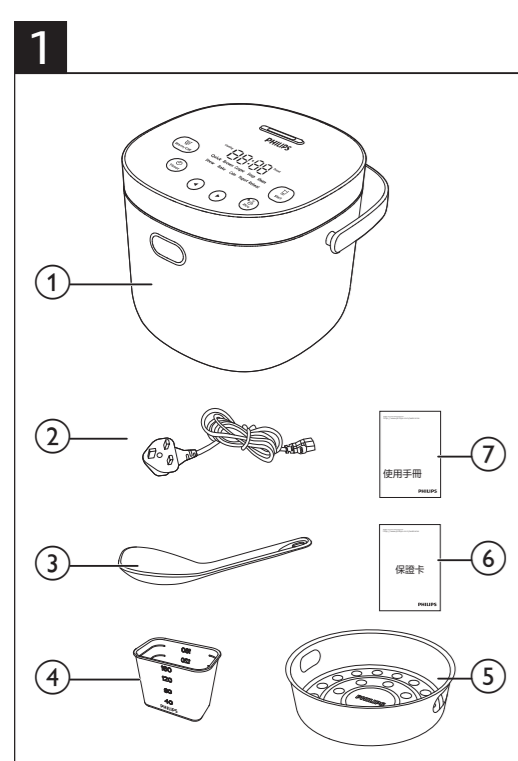

↳ The Warm Indicator lights up.

*** Tip**
After the cooking is finished, stir the brown rice and loosen it immediately to release excessive moisture for fluffy rice.

Note
Depending on the cooking conditions, the bottom portion of the brown rice may become slightly browned.

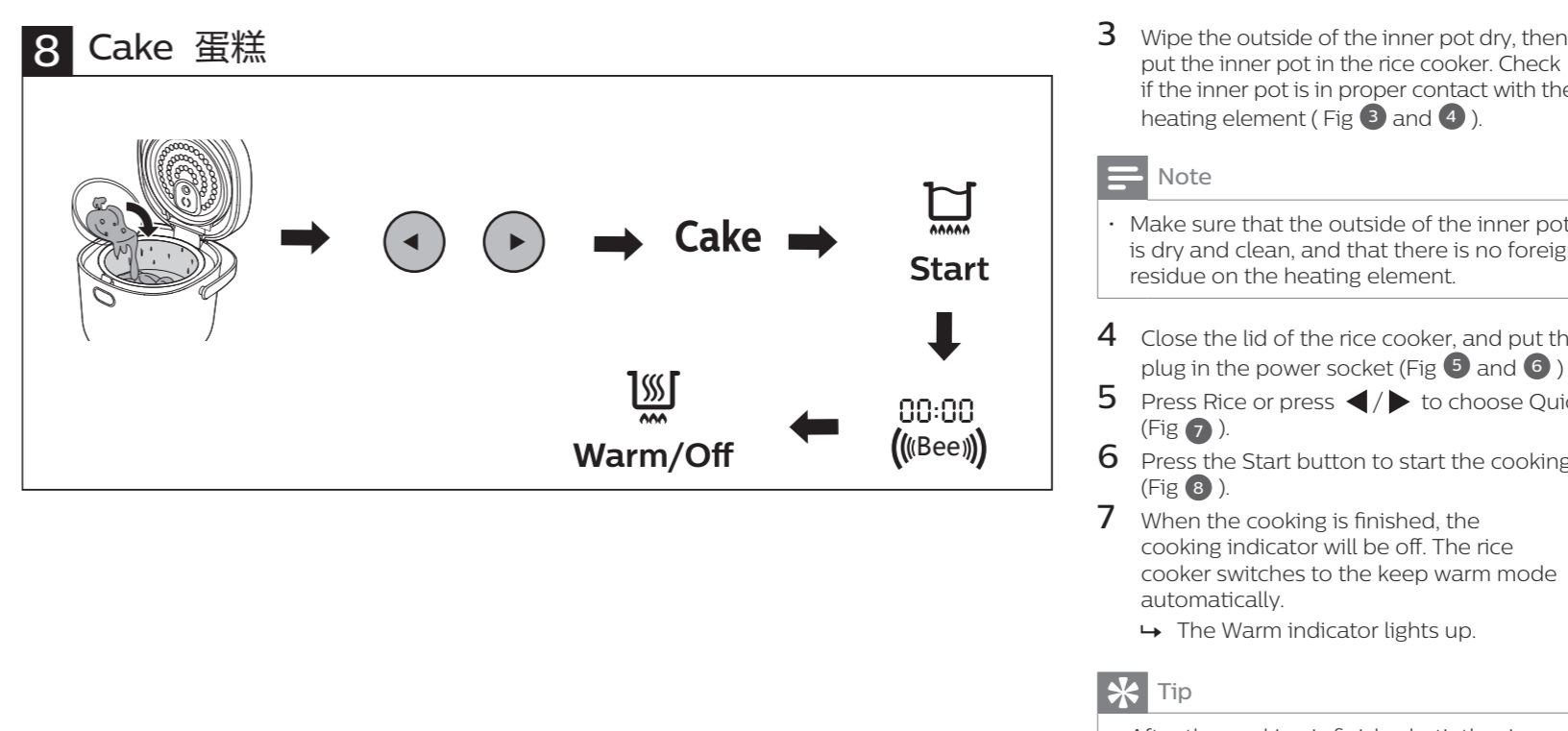
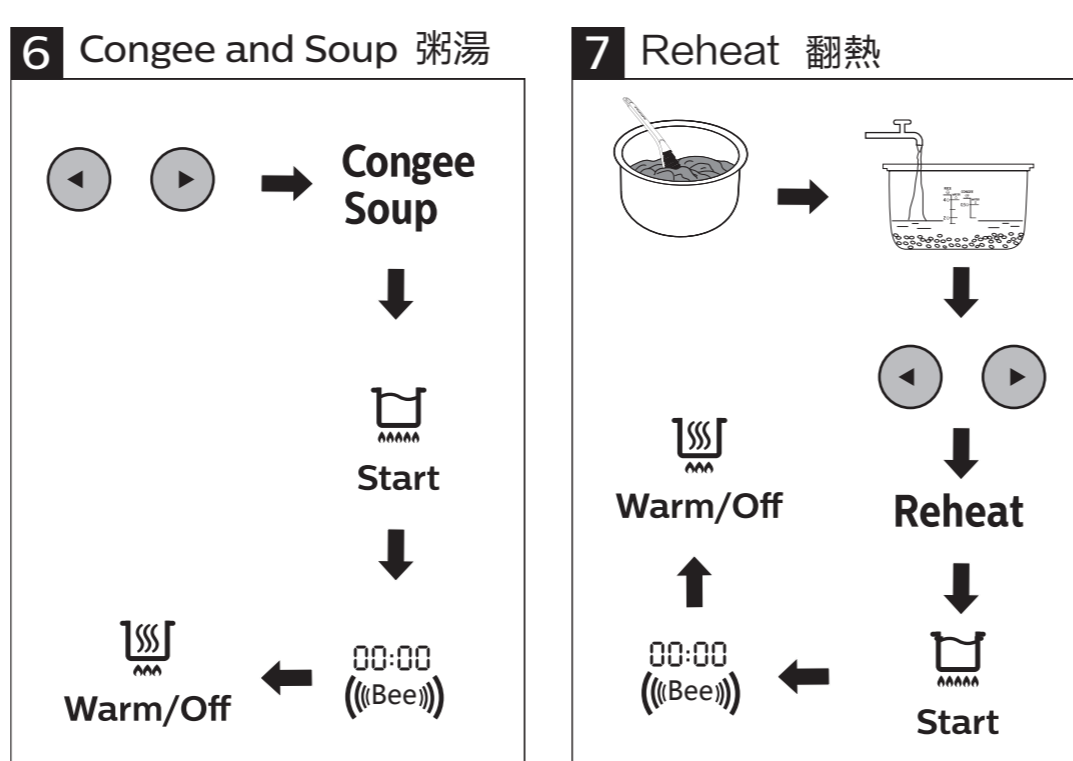
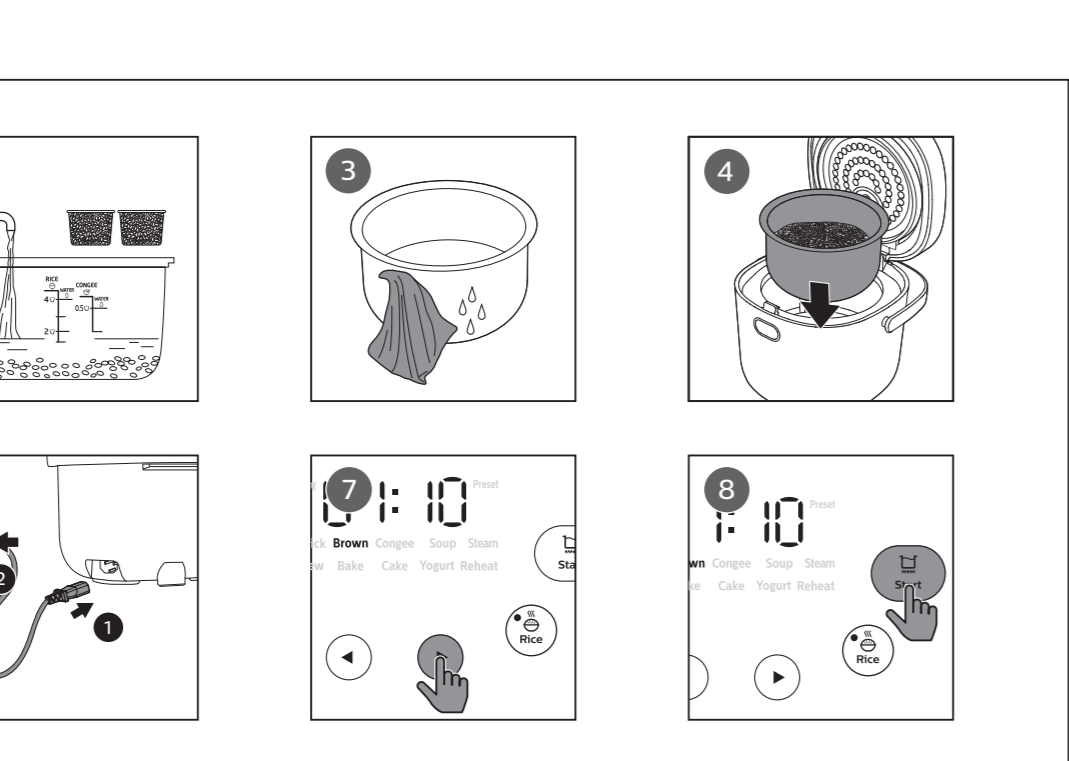
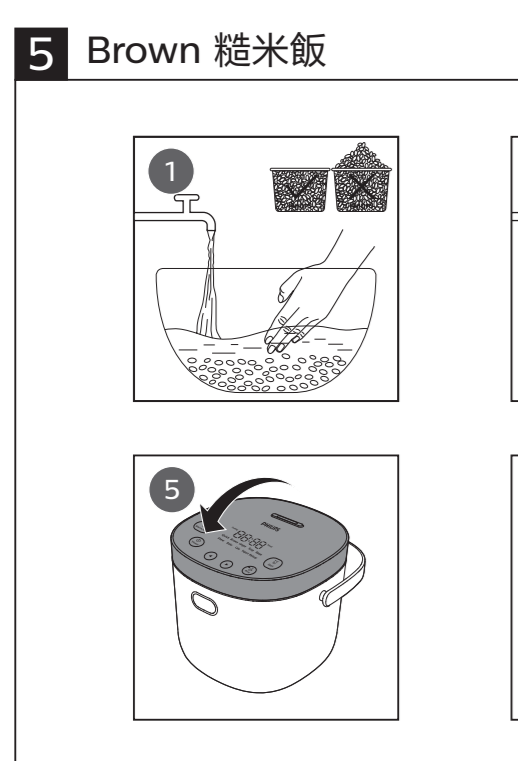

Congee and Soup (Fig 6)

Note
It is normal to find the congee stickier if it is left in keep warm mode for too long.

Do not exceed the maximum water level indicated in the inner pot, as this may cause the multicooker to overflow.

Menu	Default cooking time	Cooking time regulation range
Congee	About 2 hours	1 - 4 hours
Soup	About 2 hours	1 - 4 hours

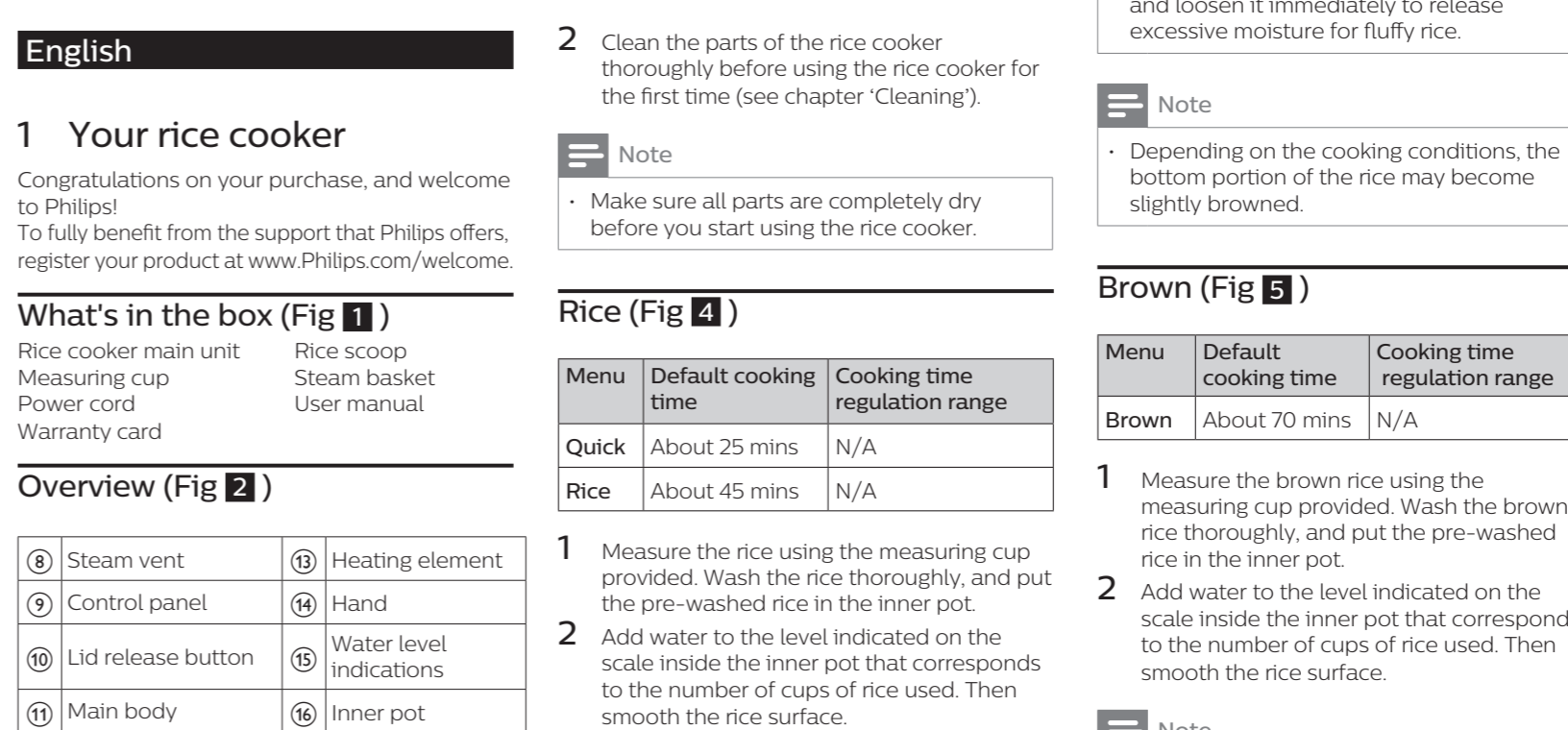
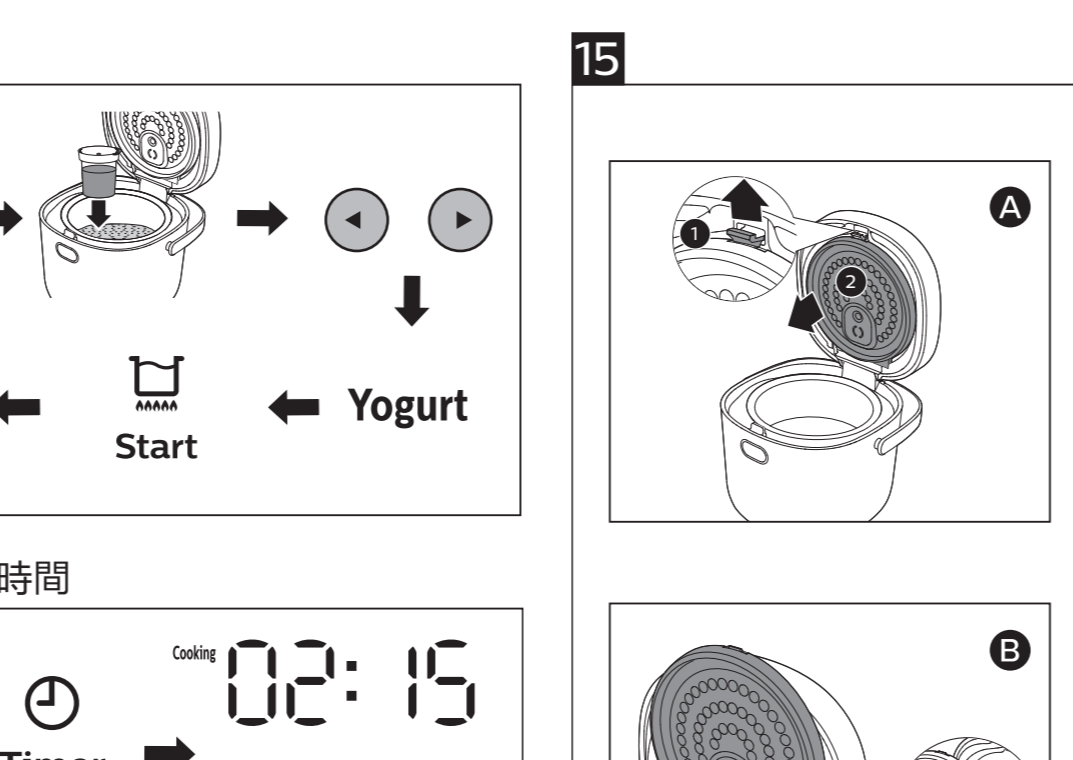
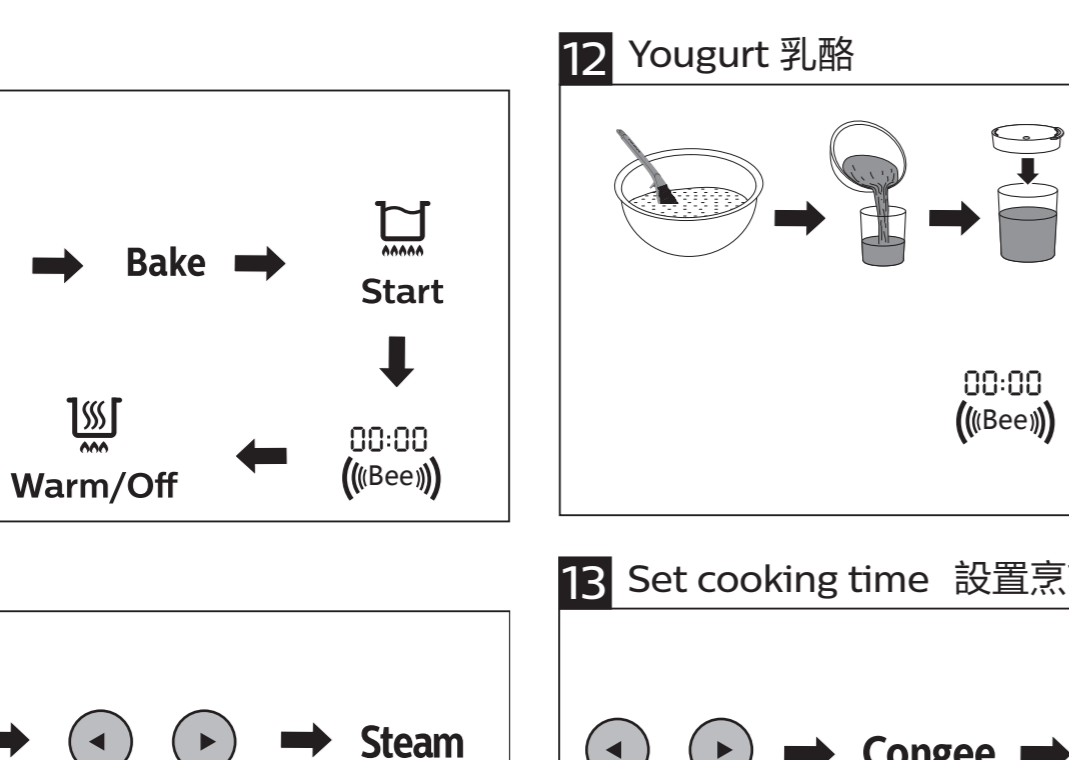
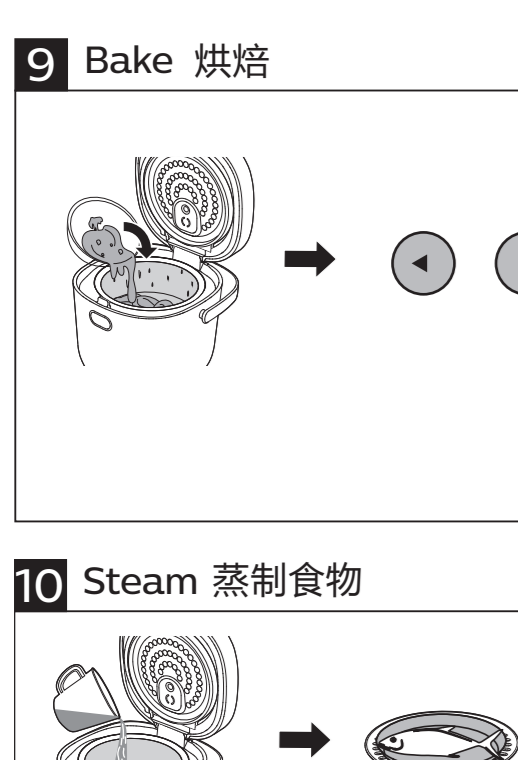

Reheat (Fig 7)

Menu	Default cooking time	Time regulation range
Reheat	About 25 mins	25 - 59 mins

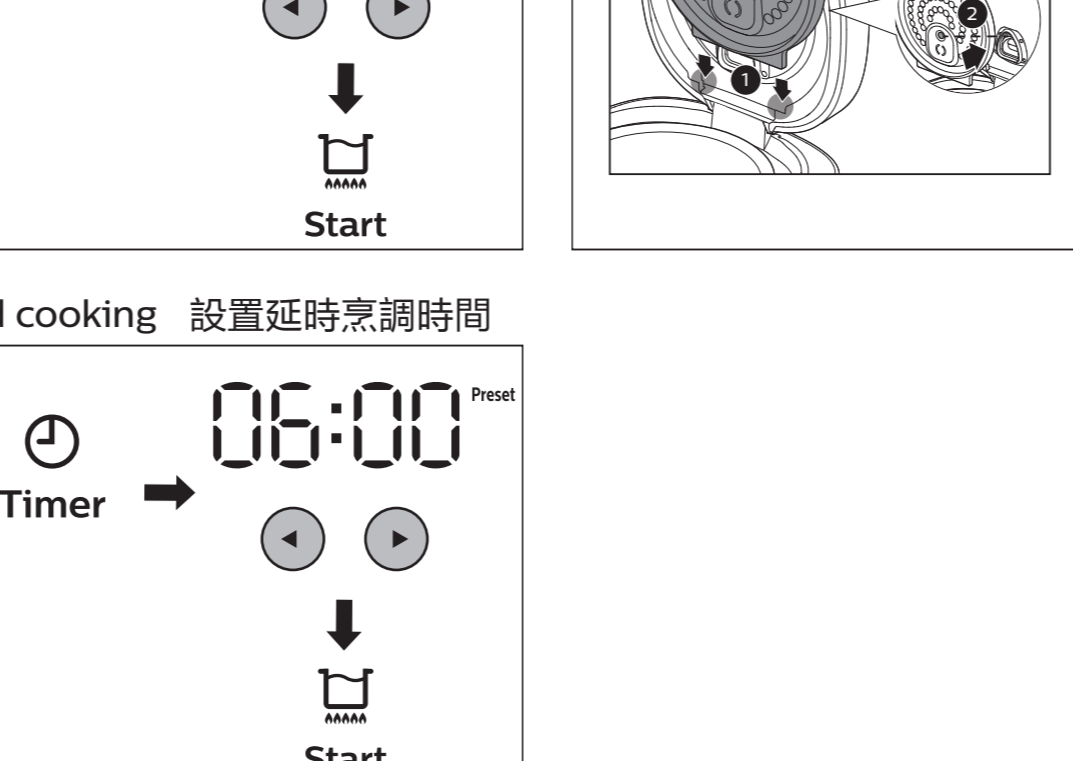
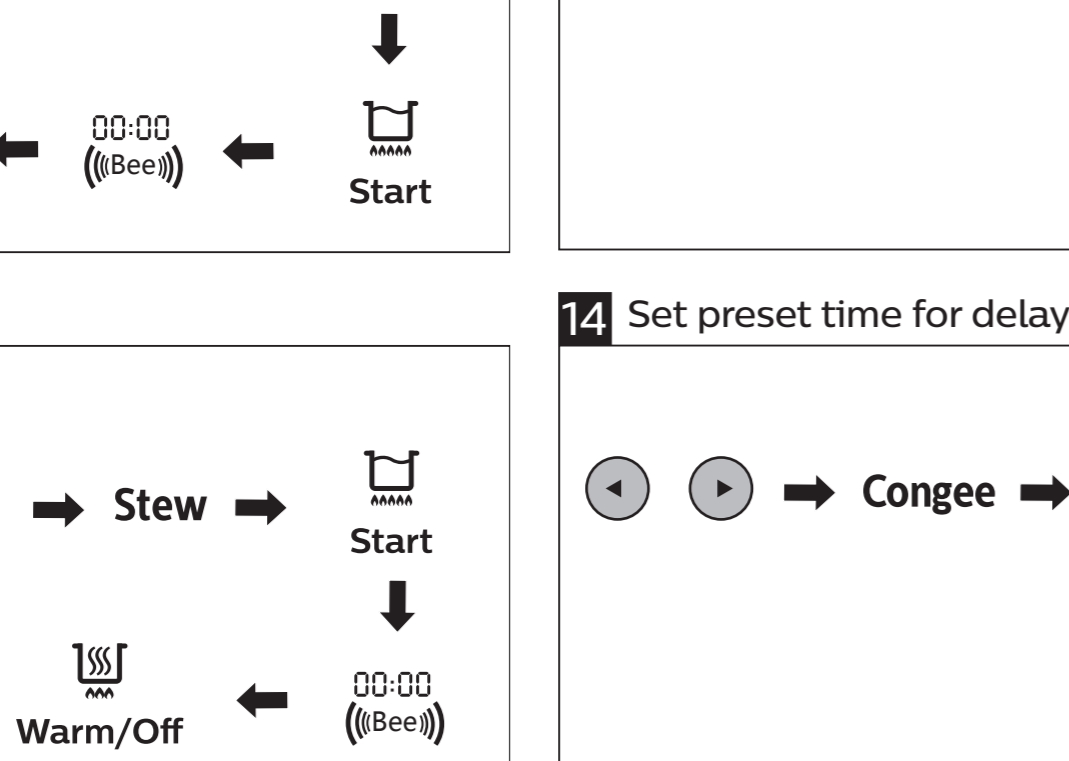
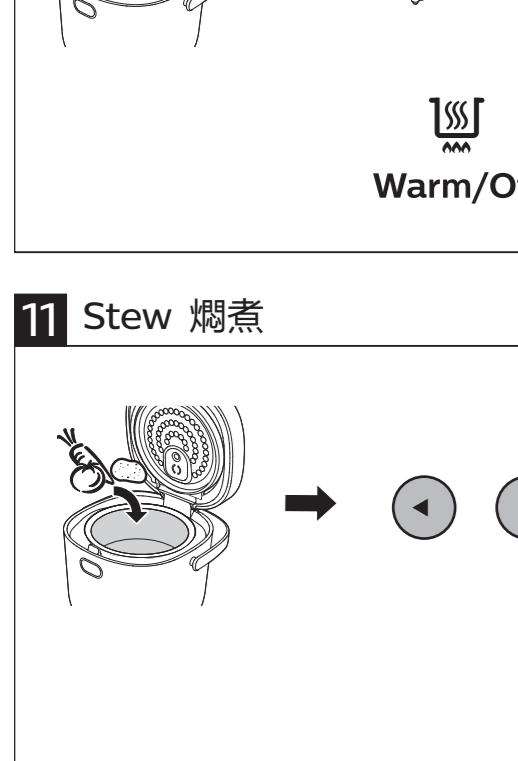

English

1 Your rice cooker
Congratulations on your purchase, and welcome to Philips! To fully benefit from the support that Philips offers, register your product at www.Philips.com/welcome.

What's in the box (Fig 1)
Rice cooker main unit, Measuring cup, Power card, Warranty card, Rice scoop, Steam basket, User manual.

Overview (Fig 2)

- ① Steam vent
- ② Control panel
- ③ Lid release button
- ④ Main body
- ⑤ Power socket
- ⑥ Heating element
- ⑦ Hand
- ⑧ Water level indications
- ⑨ Inner pot
- ⑩ Detachable lid

Controls overview (Fig 3)

- ① Display panel
- ② Warm/Off button
- ③ Timer button
- ④ Time/menu selection button
- ⑤ Rice
- ⑥ Start button
- ⑦ Menus

2 Using the rice cooker

*** Tips**
To cancel the cooking programs, press Warm/Off button, the rice cooker

Before first use
1 Take out all the accessories from the inner pot. Remove the packaging material of the inner pot.

3 Wipe the outside of the inner pot dry, then put the inner pot in the rice cooker. Check if the inner pot is in proper contact with the heating element (Fig 9 and 10).

Note
Make sure that the outside of the inner pot is dry and clean, and that there is no foreign residue on the heating element.

4 Close the lid of the rice cooker, and put the plug in the power socket (Fig 9 and 10). Press Rice or press ◀▶ to choose Quick (Fig 7).

5 Press the Start button to start the cooking (Fig 7).

6 When the cooking is finished, the cooking indicator will be off. The rice cooker switches to the keep warm mode automatically.

↳ The Warm Indicator lights up.

2 Clean the parts of the rice cooker thoroughly before using the rice cooker for the first time (see chapter 'Cleaning').

Note
Make sure all parts are completely dry before you start using the rice cooker.

Rice (Fig 4)

Menu	Default cooking time	Cooking time regulation range
Quick	About 25 mins	N/A
Rice	About 45 mins	N/A

1 Measure the rice using the measuring cup provided. Wash the rice thoroughly, and put the pre-washed rice in the inner pot.

2 Add water to the level indicated on the scale inside the inner pot that corresponds to the number of cups of rice used. Then smooth the rice surface.

Note
Each cup of uncooked rice normally gives 3 cups of cooked rice. Do not exceed the quantities indicated on the inside of the inner pot.

The level marked inside the inner pot is just an indication. You can always adjust the water level for different types of rice and your own preference. If the voltage is unstable at the area you live, it is possible that the rice cooker overflows.

Besides following the water level indications, you can also add rice and water at 1:1.5 ratio for rice cooking. Do not exceed the quantities indicated on the inside of the inner pot.

Use a separate container to wash the rice to avoid damaging the non-stick coating of the inner pot.

Make sure that the outside of the inner pot is dry and clean, and that there is no foreign residue on the heating element or the magnetic switch.

The Quick function is for cooking rice only.

4 Close the lid of the rice cooker, and put the plug in the power socket (Fig 9 and 10). Press Rice or press ◀▶ to choose Quick (Fig 7).

5 Press the Start button to start the cooking (Fig 7).

6 When the cooking is finished, the cooking indicator will be off. The rice cooker switches to the keep warm mode automatically.

↳ The Warm Indicator lights up.

*** Tip**
After the cooking is finished, stir the rice and loosen it immediately to release excessive moisture for fluffy rice.

Brown (Fig 5)

Menu	Default cooking time	Cooking time regulation range
Brown	About 70 mins	N/A

1 Measure the brown rice using the measuring cup provided. Wash the brown rice thoroughly, and put the pre-washed rice in the inner pot.

2 Add water to the level indicated on the scale inside the inner pot that corresponds to the number of cups of rice used. Then smooth the rice surface.

Note
Refer to the notes in the "Rice" section. Besides following the water level indications, you can also add brown rice and water at 1:1.5 ratio for brown rice cooking. Do not exceed the quantities indicated on the inside of the inner pot.

3 Wipe the outside of the inner pot dry, then put the inner pot in the rice cooker. Check if the inner pot is in proper contact with the heating element (Fig 9 and 10).

Note
Make sure that the outside of the inner pot is dry and clean, and that there is no foreign residue on the heating element.

4 Close the lid of the rice cooker, and put the plug in the power socket (Fig 9 and 10). Press ◀▶ to choose Brown (Fig 5).

5 Press the Start button to start the cooking (Fig 7).

6 When the cooking is finished, the cooking indicator will be off. The rice cooker switches to the keep warm mode automatically.

↳ The Warm Indicator lights up.

Cake (Fig 8)

Menu	Default cooking time	Cooking time regulation range
Cake	About 45 mins	N/A
Bake	About 35 mins	5-60 mins

1 Whisk the ingredients for cake well.

2 Coat the inner pot with some butter or cooking oil, and then pour the cake mixture into it.

3 Close the lid of the rice cooker, and put the plug in the power socket.

4 Press ◀▶ until the Cake function is selected.

5 Press Start to start the cooking.

6 When the cooking is finished, the cooking indicator will be off. The rice cooker switches to the keep warm mode automatically.

↳ The Warm Indicator lights up.

7 Open the lid and carefully take out the inner pot to cool down.

8 After the inner pot is cool down, put a plate or cake rack on top of the pot, and then flip over to take the cake out.

How to cook cakes

1 Preparation of raw material:

Small quantity:

- 3 eggs
- 100g white sugar (about 2/3 cup)
- 100g cake powder (about 1 cup)
- 50g butter (about 1/3 cup)
- 18g milk (about 1/10 cup)

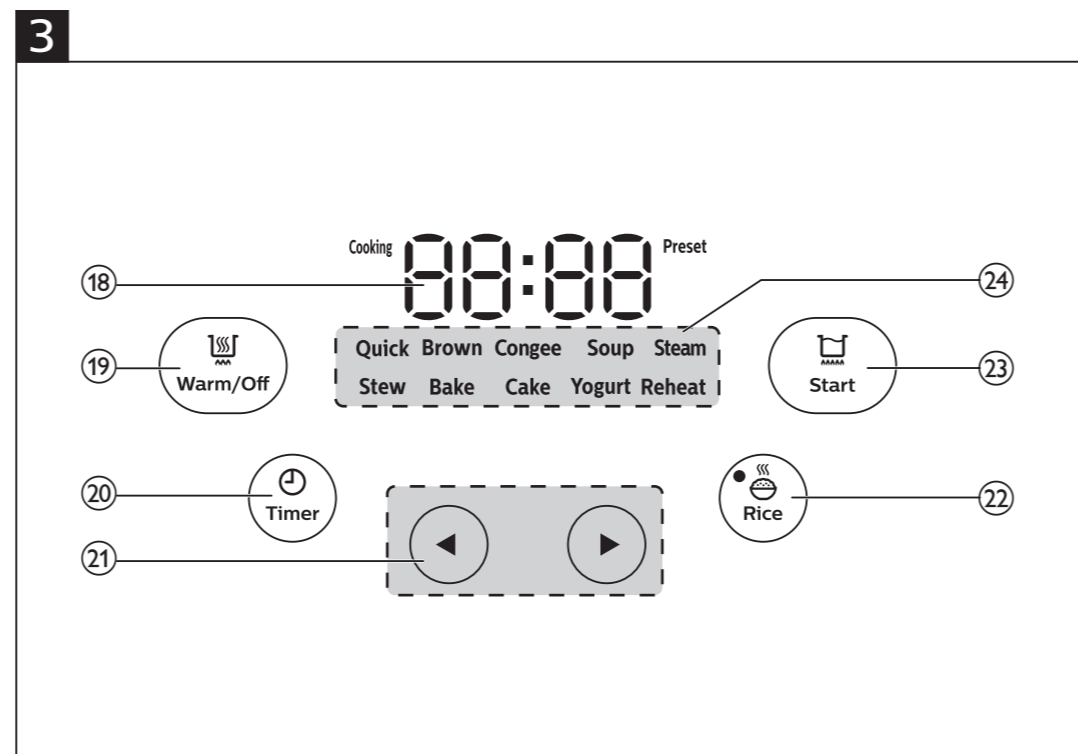
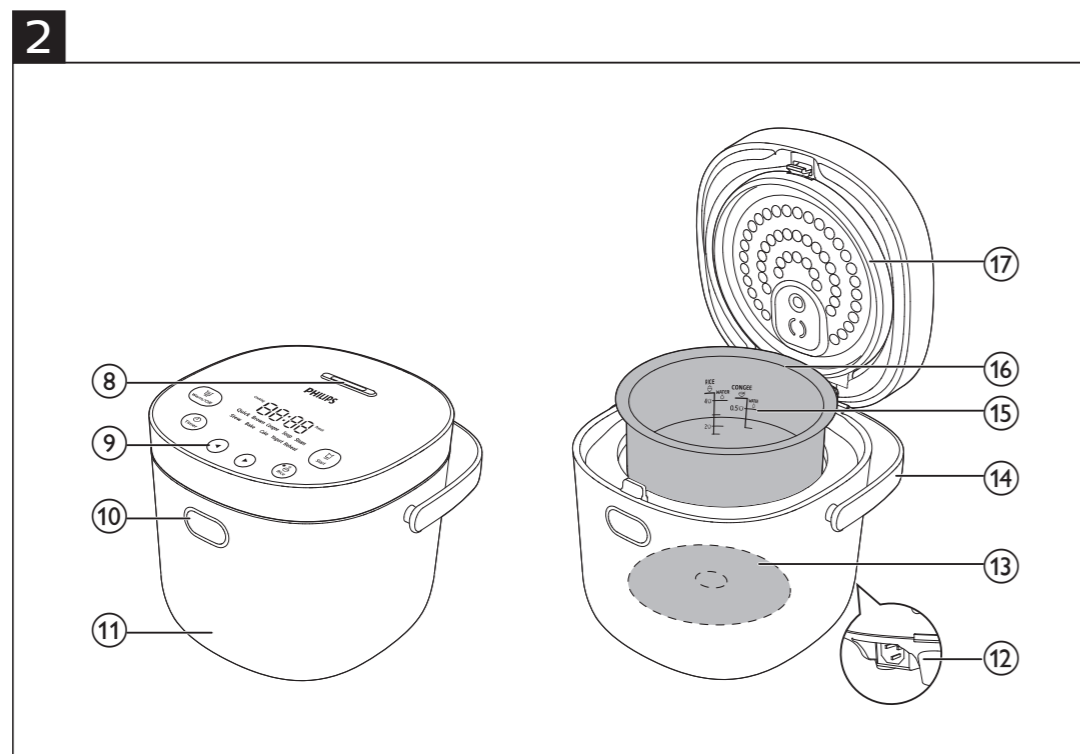
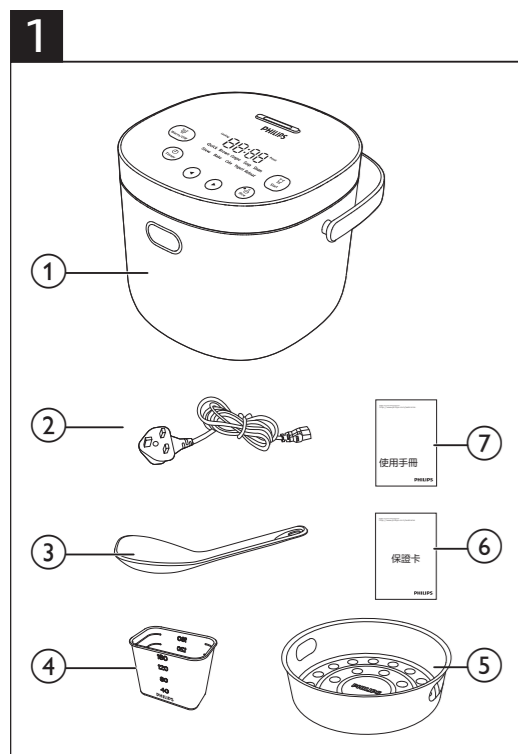

5 Brown 糙米飯

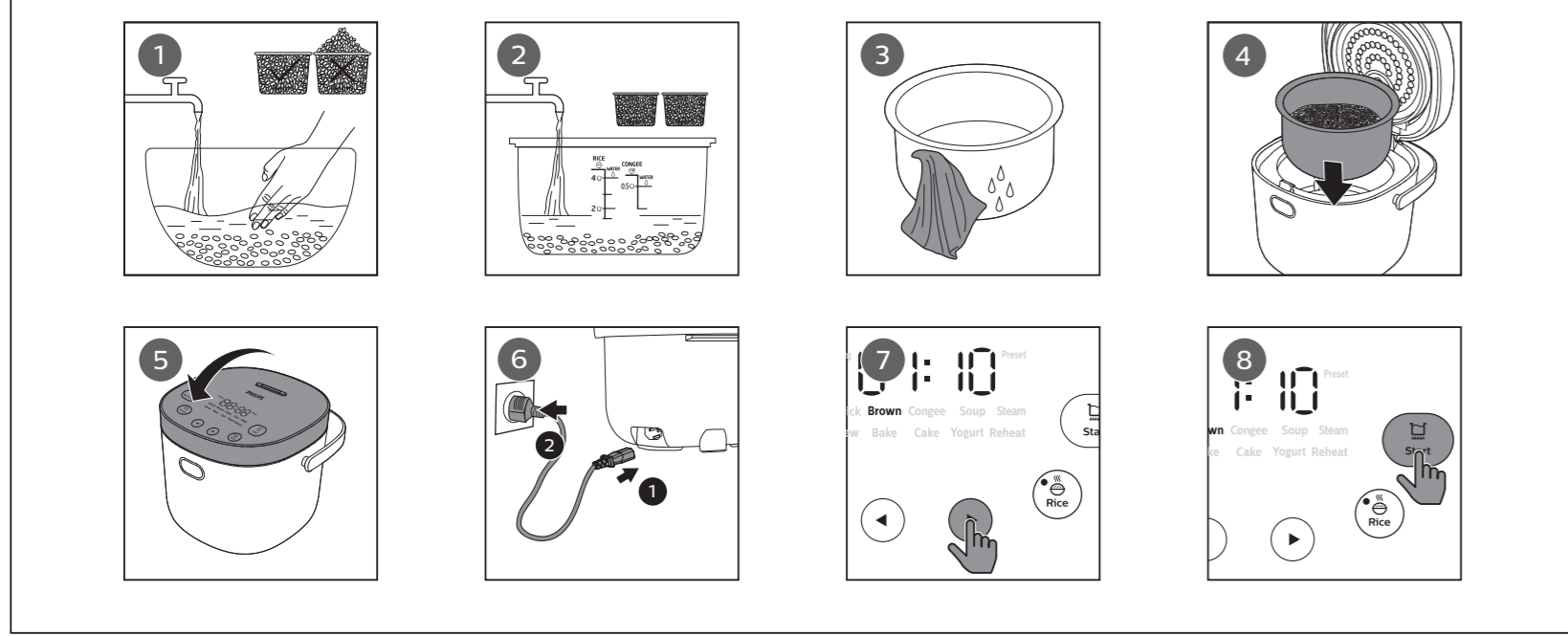

9 Bake 烘培

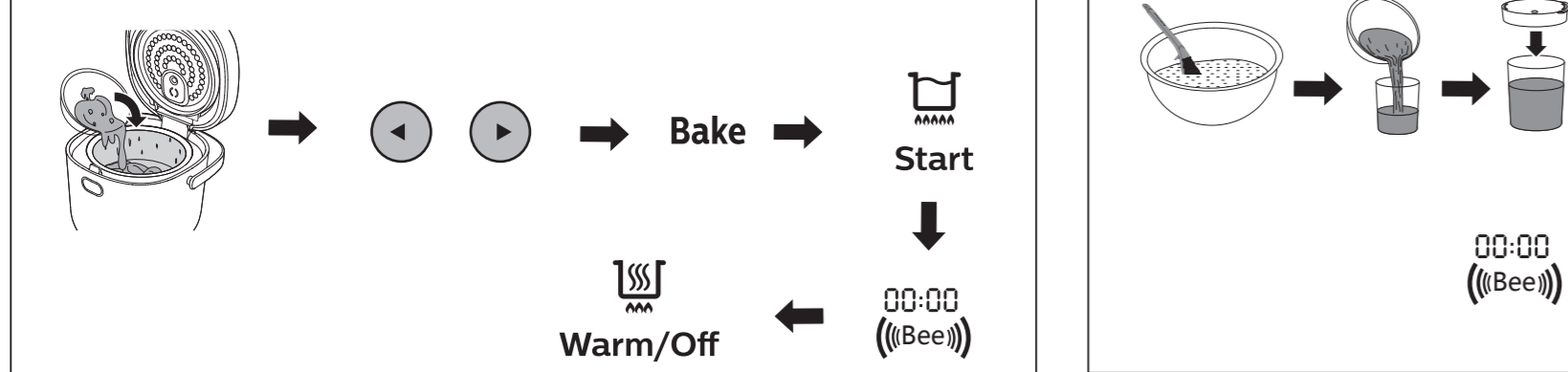

10 Steam 蒸制食物

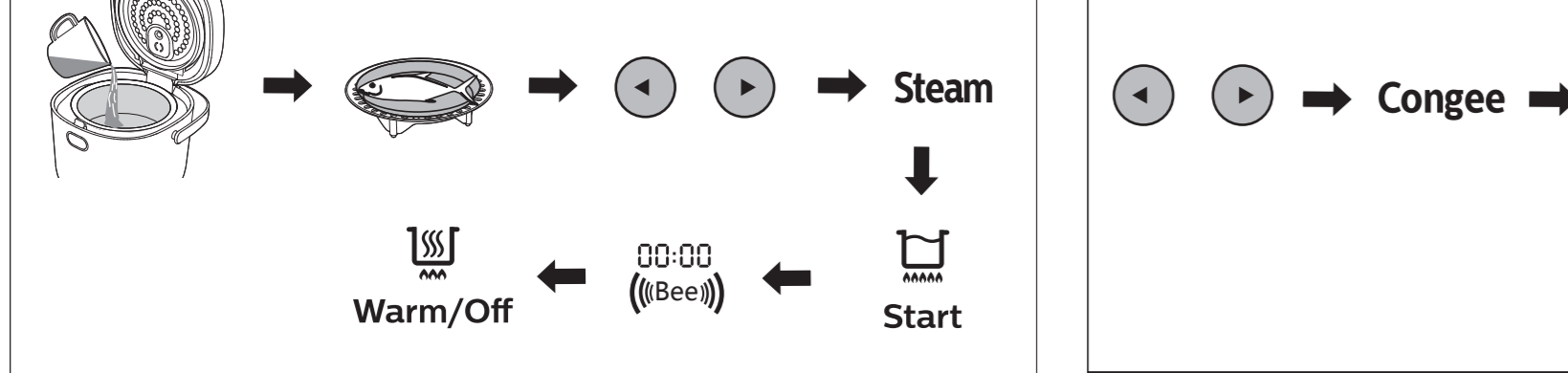

11 Stew 燉煮

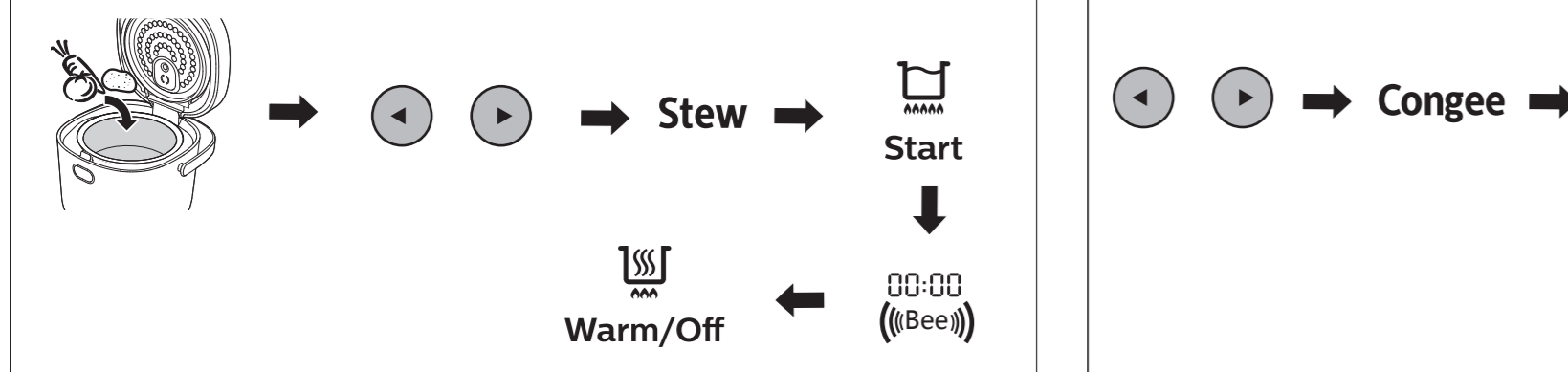

Note

- The user may adjust the raw material proportion as per personal tastes.
- Do not put in too much raw material, or the quality will be affected and even underdone.
- Separate the whites from the yolks and put them in different bowls.
- Mix round white sugar with the whites and yolks respectively, till the bubbles appear.

Note

- If the temperature of egg is too low, you may use insulated water at 40°C to warm it up. The cake made will be soft, loose and elastic.
- Whisk the egg till the egg material flows down the egg whisk as silk.
- The vessel and egg whisk must be clean. If there is oil in it, the egg mixture will not produce bubbles easily.
- To avoid scratching the nonstick coating, do not whisk the egg in the inner pot.

Bake (Fig 9)

Menu	Default cooking time	Cooking time regulation range
Bake	About 35 mins	5-60 mins

- Whisk the ingredients for bake well and put them in the yogurt cups.
- Coat the inner pot with some butter or cooking oil, and then pour the bake mixture into it.
- Clean the lid of the rice cooker, and put the plug in the power socket.
- Press <Left> until the Bake function is selected.
- Press Start to start the cooking.
- When the cooking is finished, the rice cooker indicator will be off. The rice cooker switches to the keep warm mode automatically.
- The Warm indicator lights up.
- Open the lid and carefully take out the inner pot to cool down.
- After the inner pot is cool down, put a plate on top of the pot, and then flip over to take the baked food out.

Steam (Fig 10)

Cooking functions	Default cooking time	Time regulation range
Steam	About 20 mins	10 - 40 mins

12 Yougurt 乳酪

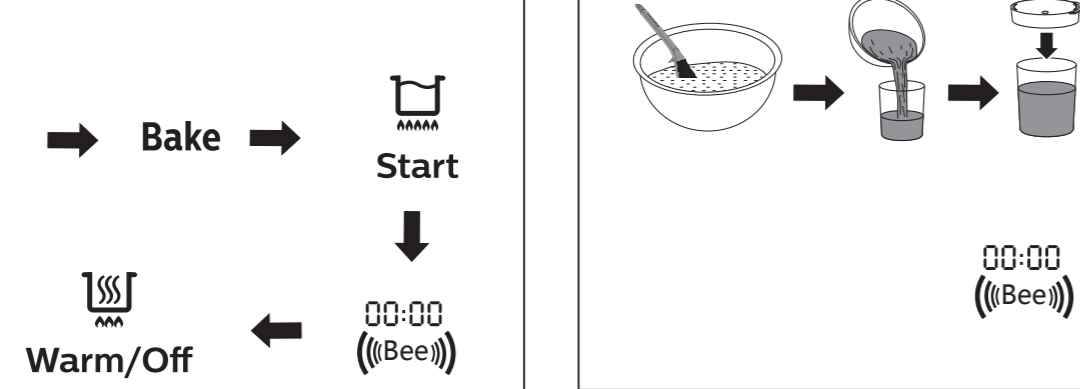

Note

- The Steam function is for steaming foods only.
- Whening steaming foods, water can not exceed the upper surface of the steam basket, or the food will be immersed in water.

Stew (Fig 11)

Cooking functions	Default cooking time	Time regulation range
Stew	About 4 hrs	2-8 hrs

- Put the ingredients into the inner pot.
- Wipe off water outside of the inner pot and put it into the appliance.
- Press <Left> until the Stew function is selected.
- Press Start to start the cooking.
- When the cooking is finished, the rice cooker indicator will be off. The rice cooker switches to the keep warm mode automatically.
- The Warm indicator lights up.

Note

- The Steam function is for steaming foods only.
- Whening steaming foods, water can not exceed the upper surface of the steam basket, or the food will be immersed in water.

Yogurt (Fig 12)

Menu	Default cooking time	Time regulation range
Yogurt	6 hrs	4 - 12 hrs

- Whisk the ingredients for the yogurt well and put them in the yogurt cups.
- Put the yogurt cups in the inner pot. Make sure that yogurt cups sealed.
- Pour some water in the inner pot. Make sure that half of the yogurt cups are immersed in water.
- Press <Left> until the Yogurt function is selected.
- Press Start to start the cooking.
- When the cooking is finished, the rice cooker switches to the keep warm mode automatically.
- The Warm indicator lights up.

Adjusting the cooking time (Fig 13)

- You can set the cooking time for some menus. Refer to the cooking time table in each chapter for the detailed regulating range.
- Press Start to the cooking time you need.
 - Press Timer repeatedly until Cooking displayed on the screen.

Disassemble the inner lid (Fig 15)

- To disassemble the inner lid, press the clamp on top of the lid (1), and then pull the lid out (Fig 15).
- To assemble the inner lid, attach the lock on the bottom of the inner lid to the slot on the top lid, and then aim the high spot in the triangle at the hole in the center of the inner lid (Fig 15).

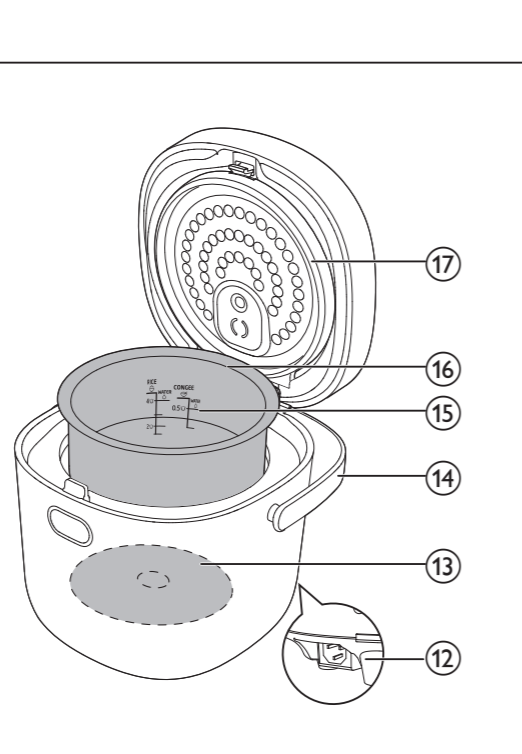

6 Congee and Soup 粥湯

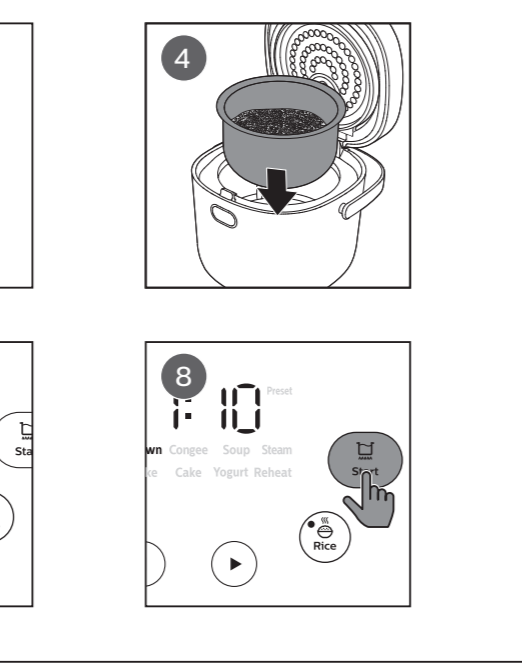

13 Set cooking time 設置烹調時間

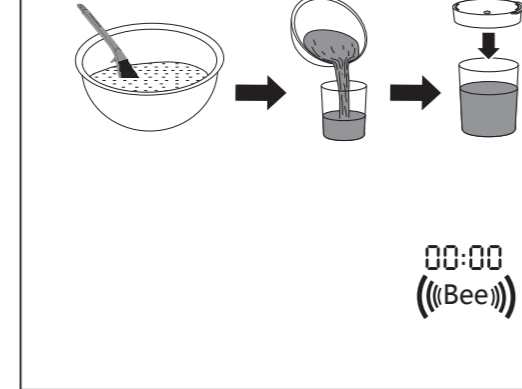

14 Set preset time for delayed cooking 設置延時烹調時間

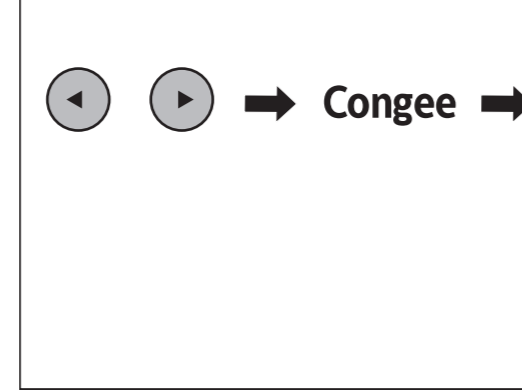

15

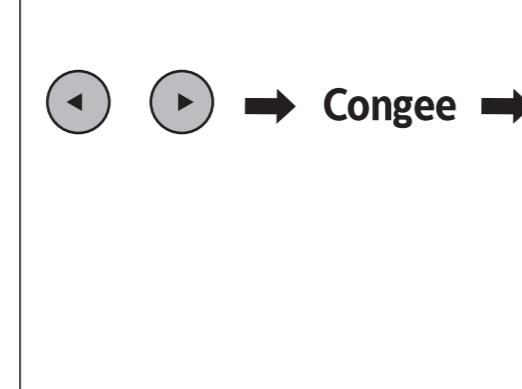

Note

- Press <Left> or <Right> to select the cooking time you need.
- Press Start to confirm the cooking time and start the cooking process. The cooking process will be finished by the time when the cooking time has elapsed.

Pre-set time for delayed cooking (Fig 14)

- You can preset the delayed cooking time for some menus. The preset timer is available from 1 hour up to 24 hours.
- The cooking process will be finished by the time the preset time has elapsed. For instance, if the current time is 12:00 (noon time), and you would like the rice ready by 18:00 in the afternoon, you need to set the preset time of 6 hours.
 - If the preset time is shorter than the cooking time, the cooking process will start immediately.
 - The preset timer is not available in the following menus: Reheat, Yogurt and Cake.

Tip

- Press and hold <Left> or <Right> to fast forward in choosing the cooking time.

3 Cleaning and Maintenance

Note

- Unplug the appliance before cleaning.
- Wait until the appliance has cooled down sufficiently before cleaning.
- Maker sure to clean the detachable inner lid regularly, otherwise it will discolour and develop a foul odor.
- Do not use scouring pads or other hard objects to clean the inner pot and top lid.

Tip

- Use a soft glove or cloth to clean the top lid.
- The inner pot has a nonstick coating. Do not use scouring pads or other hard objects to clean it. Use the steam Steam function for easier cleaning.

7 Reheat 翻熱

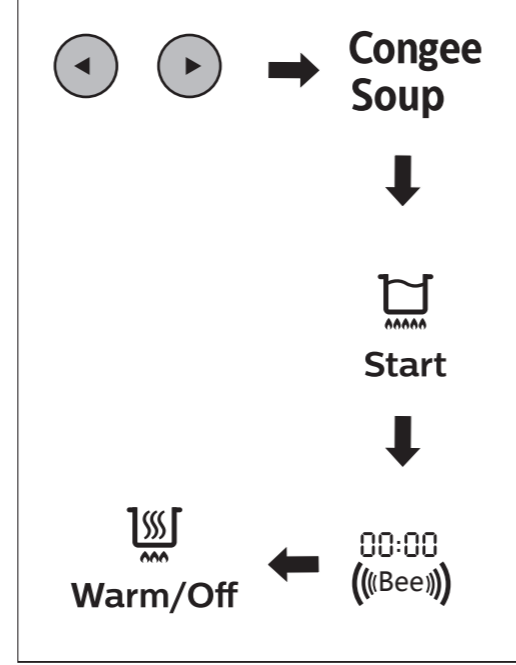

15

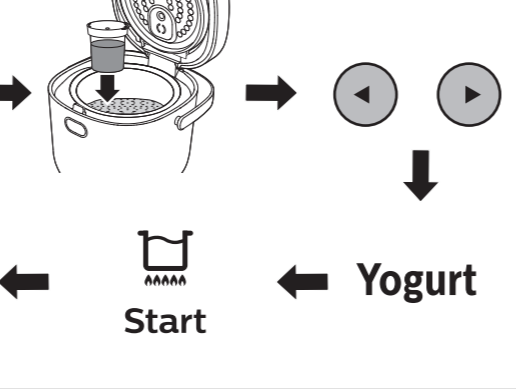

15

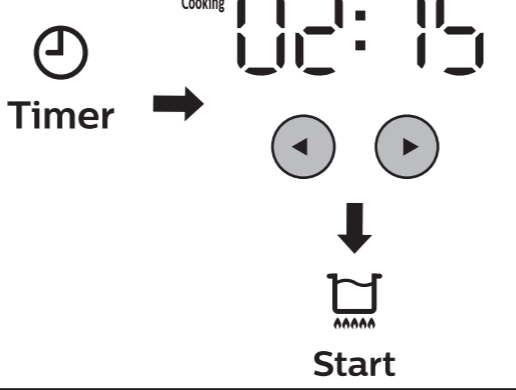

15

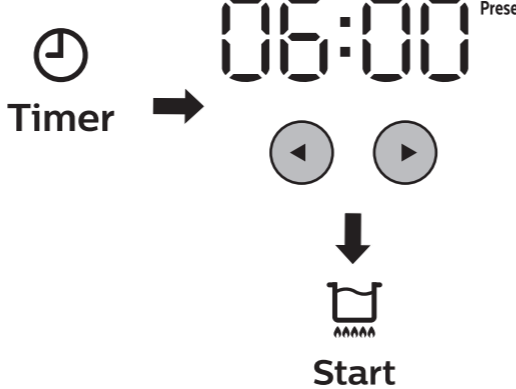

15

- Press <Left> or <Right> to select the cooking time you need.
- Press Start to confirm the cooking time and start the cooking process. The cooking process will be finished by the time when the cooking time has elapsed.

Pre-set time for delayed cooking (Fig 14)

- You can preset the delayed cooking time for some menus. The preset timer is available from 1 hour up to 24 hours.
- The cooking process will be finished by the time the preset time has elapsed. For instance, if the current time is 12:00 (noon time), and you would like the rice ready by 18:00 in the afternoon, you need to set the preset time of 6 hours.
 - If the preset time is shorter than the cooking time, the cooking process will start immediately.
 - The preset timer is not available in the following menus: Reheat, Yogurt and Cake.

Tip

- Press and hold <Left> or <Right> to fast forward in choosing the cooking time.

3 Cleaning and Maintenance

Note

- Unplug the appliance before cleaning.
- Wait until the appliance has cooled down sufficiently before cleaning.
- Maker sure to clean the detachable inner lid regularly, otherwise it will discolour and develop a foul odor.
- Do not use scouring pads or other hard objects to clean the inner pot and top lid.

Tip

- Use a soft glove or cloth to clean the top lid.
- The inner pot has a nonstick coating. Do not use scouring pads or other hard objects to clean it. Use the steam Steam function for easier cleaning.

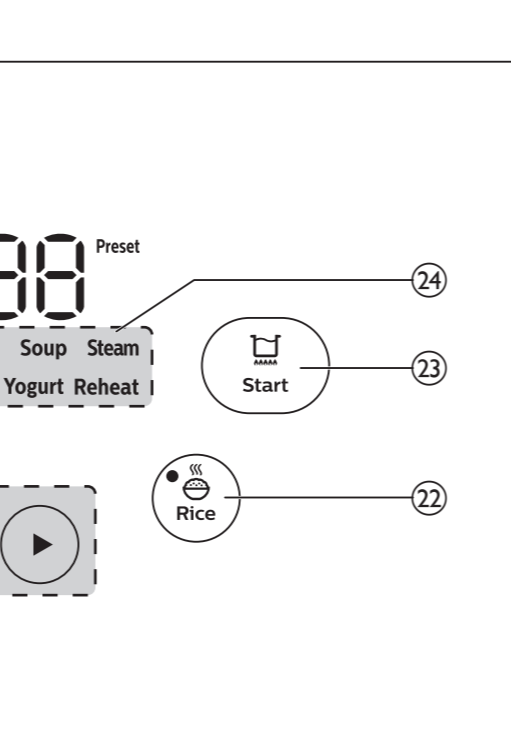

8 Cake 蛋糕

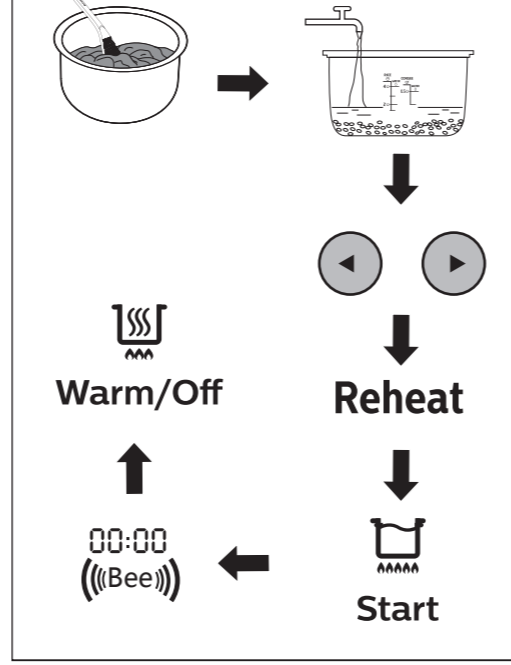

15

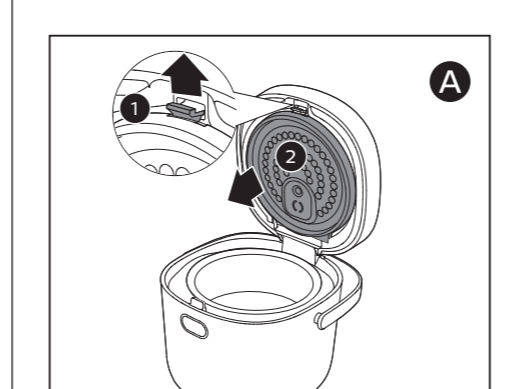

15

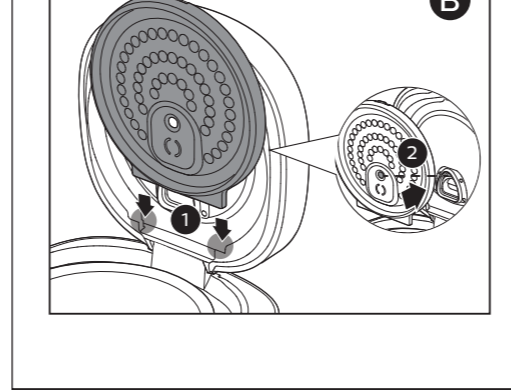

15



15

- Press <Left> or <Right> to select the cooking time you need.
- Press Start to confirm the cooking time and start the cooking process. The cooking process will be finished by the time when the cooking time has elapsed.

Pre-set time for delayed cooking (Fig 14)

- You can preset the delayed cooking time for some menus. The preset timer is available from 1 hour up to 24 hours.
- The cooking process will be finished by the time the preset time has elapsed. For instance, if the current time is 12:00 (noon time), and you would like the rice ready by 18:00 in the afternoon, you need to set the preset time of 6 hours.
 - If the preset time is shorter than the cooking time, the cooking process will start immediately.
 - The preset timer is not available in the following menus: Reheat, Yogurt and Cake.

Tip

- Press and hold <Left> or <Right> to fast forward in choosing the cooking time.

3 Cleaning and Maintenance

Note

- Unplug the appliance before cleaning.
- Wait until the appliance has cooled down sufficiently before cleaning.
- Maker sure to clean the detachable inner lid regularly, otherwise it will discolour and develop a foul odor.
- Do not use scouring pads or other hard objects to clean the inner pot and top lid.

Tip

- Use a soft glove or cloth to clean the top lid.
- The inner pot has a nonstick coating. Do not use scouring pads or other hard objects to clean it. Use the steam Steam function for easier cleaning.

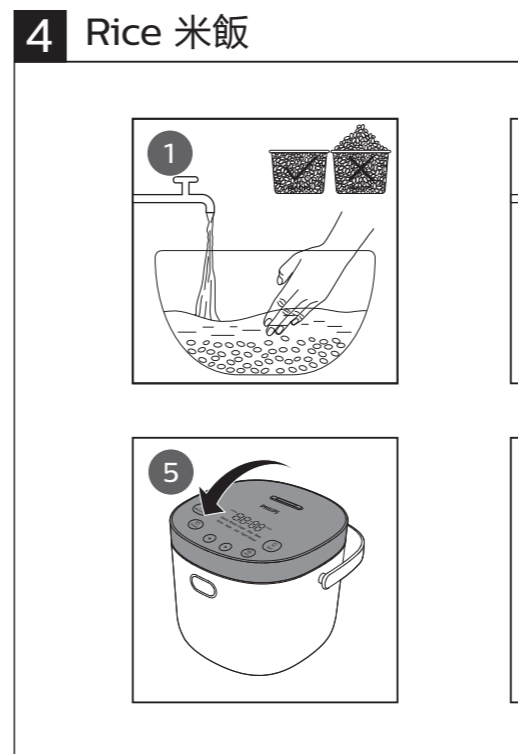

4 Rice 米飯

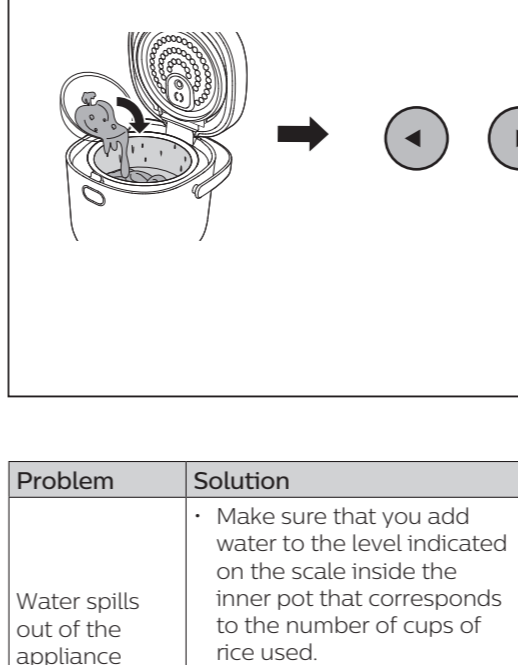

15

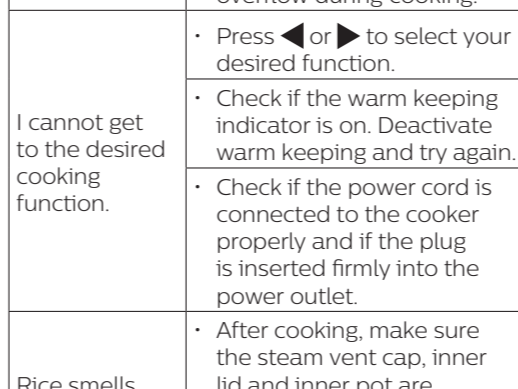

15

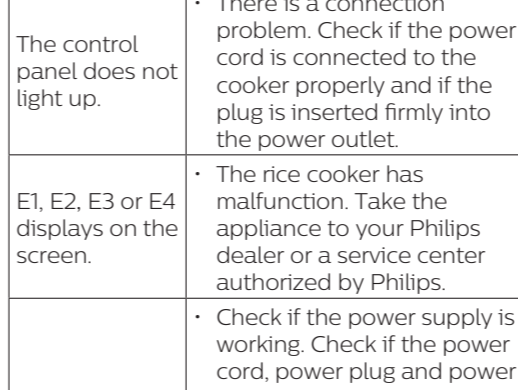

15

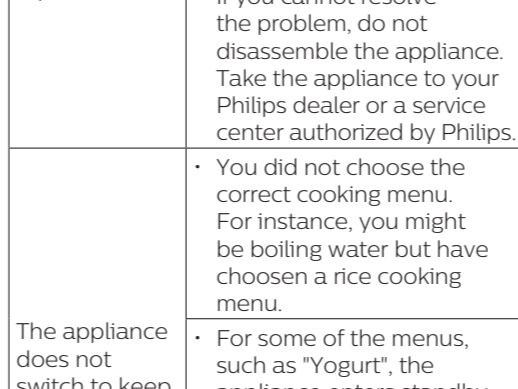

15

- Press <Left> or <Right> to select the cooking time you need.
- Press Start to confirm the cooking time and start the cooking process. The cooking process will be finished by the time when the cooking time has elapsed.

Pre-set time for delayed cooking (Fig 14)

- You can preset the delayed cooking time for some menus. The preset timer is available from 1 hour up to 24 hours.
- The cooking process will be finished by the time the preset time has elapsed. For instance, if the current time is 12:00 (noon time), and you would like the rice ready by 18:00 in the afternoon, you need to set the preset time of 6 hours.
 - If the preset time is shorter than the cooking time, the cooking process will start immediately.
 - The preset timer is not available in the following menus: Reheat, Yogurt and Cake.

Tip

- Press and hold <Left> or <Right> to fast forward in choosing the cooking time.

3 Cleaning and Maintenance

Note

- Unplug the appliance before cleaning.
- Wait until the appliance has cooled down sufficiently before cleaning.
- Maker sure to clean the detachable inner lid regularly, otherwise it will discolour and develop a foul odor.
- Do not use scouring pads or other hard objects to clean the inner pot and top lid.

Tip

- Use a soft glove or cloth to clean the top lid.
- The inner pot has a nonstick coating. Do not use scouring pads or other hard objects to clean it. Use the steam Steam function for easier cleaning.

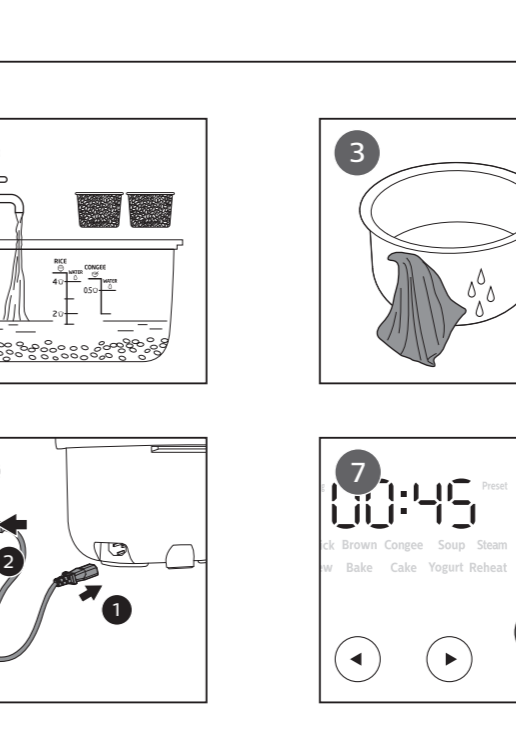

5 Brown 糙米飯



15

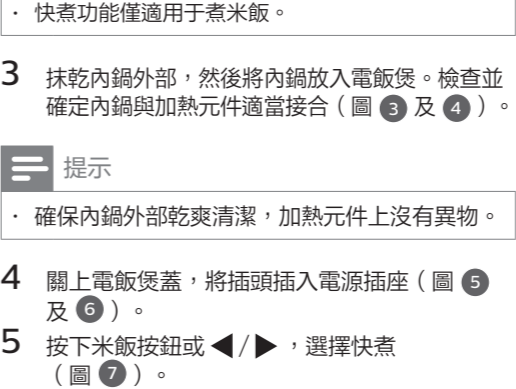

15

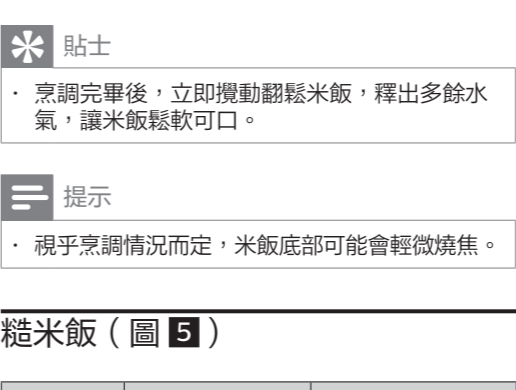

15

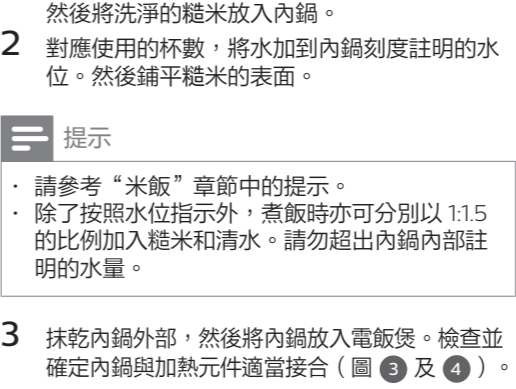

15

- Press <Left> or <Right> to select the cooking time you need.
- Press Start to confirm the cooking time and start the cooking process. The cooking process will be finished by the time when the cooking time has elapsed.

Pre-set time for delayed cooking (Fig 14)

- You can preset the delayed cooking time for some menus. The preset timer is available from 1 hour up to 24 hours.
- The cooking process will be finished by the time the preset time has elapsed. For instance, if the current time is 12:00 (noon time), and you would like the rice ready by 18:00 in the afternoon, you need to set the preset time of 6 hours.
 - If the preset time is shorter than the cooking time, the cooking process will start immediately.
 - The preset timer is not available in the following menus: Reheat, Yogurt and Cake.

Tip

- Press and hold <Left> or <Right> to fast forward in choosing the cooking time.

3 Cleaning and Maintenance

Note

- Unplug the appliance before cleaning.
- Wait until the appliance has cooled down sufficiently before cleaning.
- Maker sure to clean the detachable inner lid regularly, otherwise it will discolour and develop a foul odor.
- Do not use scouring pads or other hard objects to clean the inner pot and top lid.

Tip

- Use a soft glove or cloth to clean the top lid.
- The inner pot has a nonstick coating. Do not use scouring pads or other hard objects to clean it. Use the steam Steam function for easier cleaning.

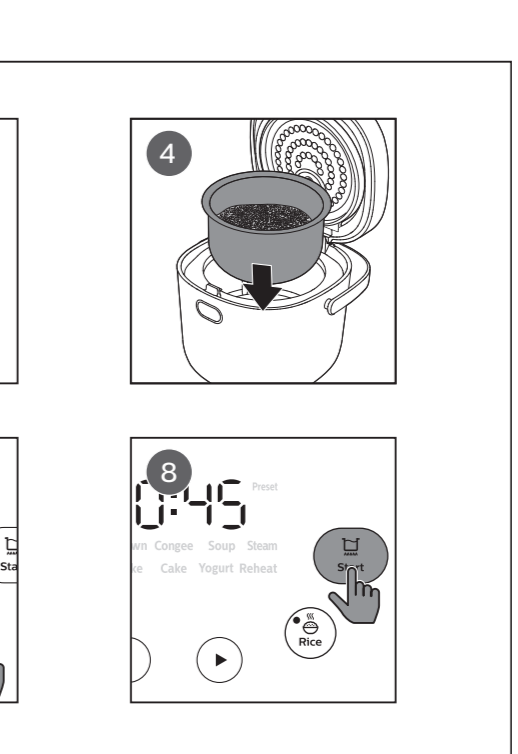

6 Congee and Soup 粥湯

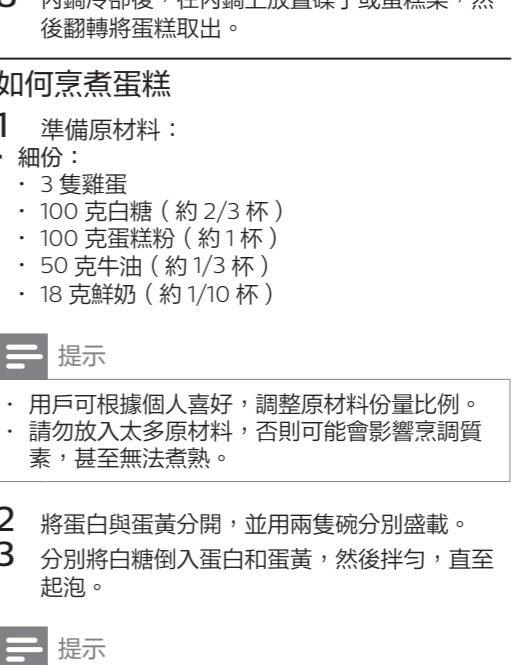

13 Set cooking time 設置烹調時間

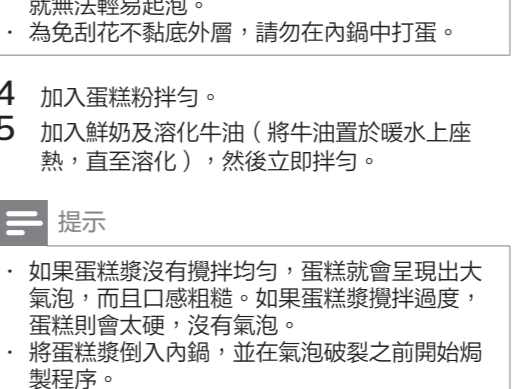

14 Set preset time for delayed cooking 設置延時烹調時間

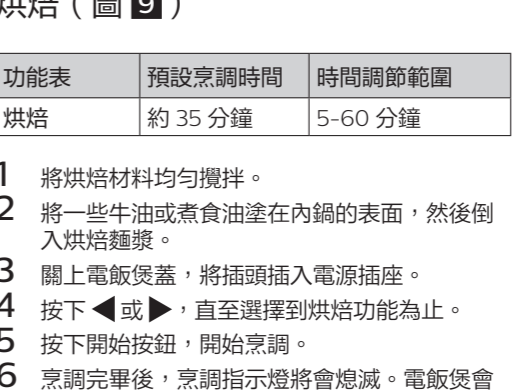

15

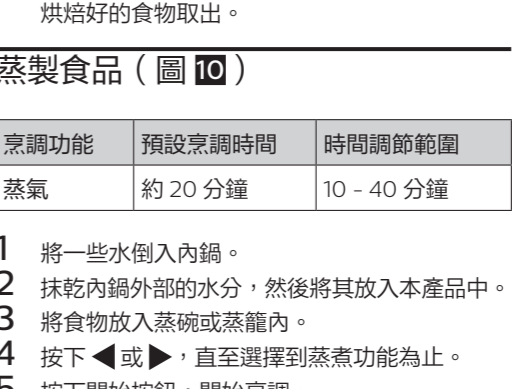

15

- Press <Left> or <Right> to select the cooking time you need.
- Press Start to confirm the cooking time and start the cooking process. The cooking process will be finished by the time when the cooking time has elapsed.

Pre-set time for delayed cooking (Fig 14)

- You can preset the delayed cooking time for some menus. The preset timer is available from 1 hour up to 24 hours.
- The cooking process will be finished by the time the preset time has elapsed. For instance, if the current time is 12:00 (noon time), and you would like the rice ready by 18:00 in the afternoon, you need to set the preset time of 6 hours.
 - If the preset time is shorter than the cooking time, the cooking process will start immediately.
 - The preset timer is not available in the following menus: Reheat, Yogurt and Cake.

Tip

- Press and hold <Left> or <Right> to fast forward in choosing the cooking time.

3 Cleaning and Maintenance

Note

- Unplug the appliance before cleaning.
- Wait until the appliance has cooled down sufficiently before cleaning.
- Maker sure to clean the detachable inner lid regularly, otherwise it will discolour and develop a foul odor.
- Do not use scouring pads or other hard objects to clean the inner pot and top lid.

Tip

- Use a soft glove or cloth to clean the top lid.
- The inner pot has a nonstick coating. Do not use scouring pads or other hard objects to clean it. Use the steam Steam function for easier cleaning.

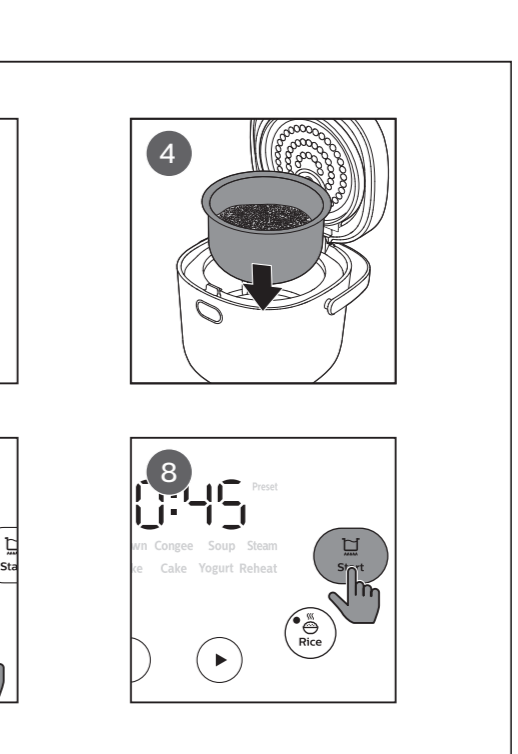

7 Reheat 翻熱

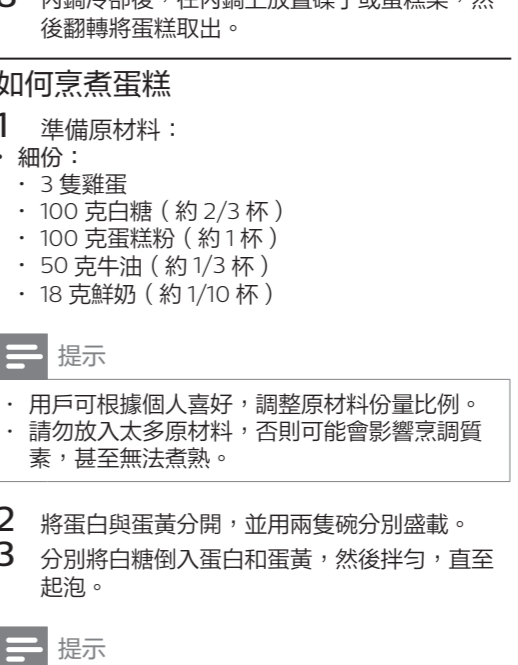

15

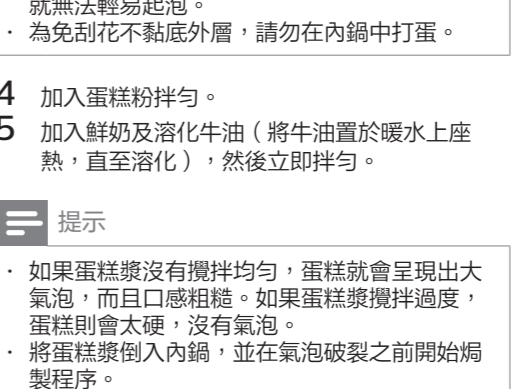

15

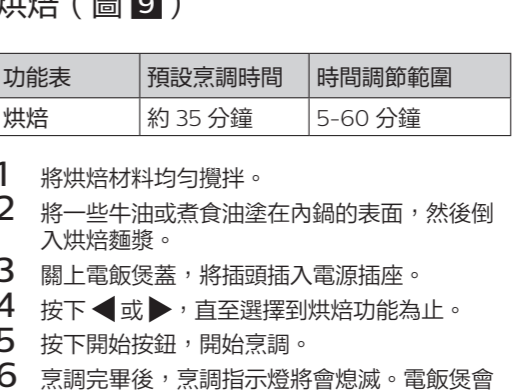

15

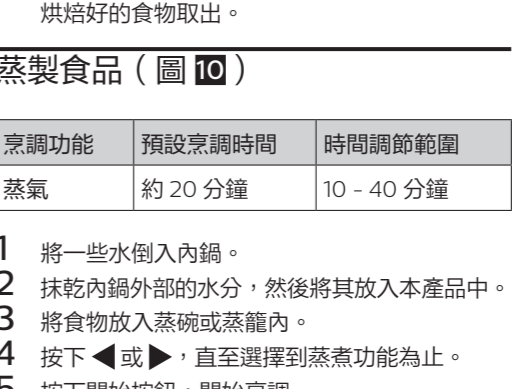

15

- Press <Left> or <Right> to select the cooking time you need.
- Press Start to confirm the cooking time and start the cooking process. The cooking process will be finished by the time when the cooking time has elapsed.

Pre-set time for delayed cooking (Fig 14)

- You can preset the delayed cooking time for some menus. The preset timer is available from 1 hour up to 24 hours.
- The cooking process will be finished by the time the preset time has elapsed. For instance, if the current time is 12:00 (noon time), and you would like the rice ready by 18:00 in the afternoon, you need to set the preset time of 6 hours.
 - If the preset time is shorter than the cooking time, the cooking process will start immediately.
 - The preset timer is not available in the following menus: Reheat, Yogurt and Cake.

Tip

- Press and hold <Left> or <Right> to fast forward in choosing the cooking time.

3 Cleaning and Maintenance

Note

- Unplug the appliance before cleaning.
- Wait until the appliance has cooled down sufficiently before cleaning.
- Maker sure to clean the detachable inner lid regularly, otherwise it will discolour and develop a foul odor.
- Do not use scouring pads or other hard objects to clean the inner pot and top lid.

Tip

- Use a soft glove or cloth to clean the top lid.
- The inner pot has a nonstick coating. Do not use scouring pads or other hard objects to clean it. Use the steam Steam function for easier cleaning.

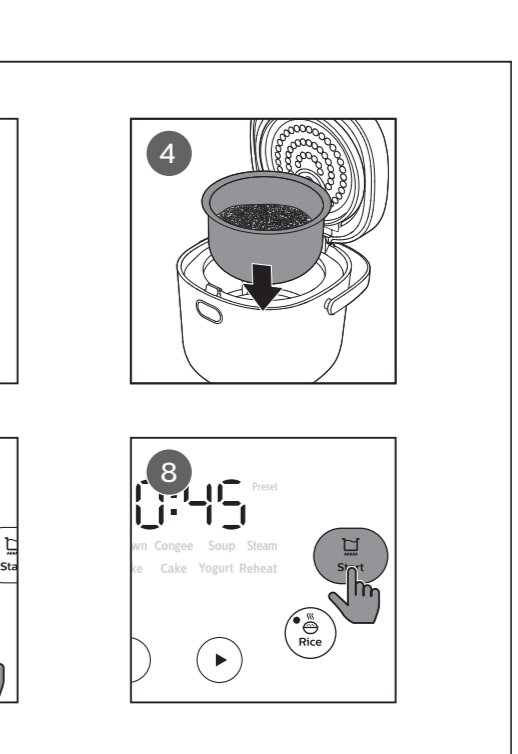

8 Cake 蛋糕

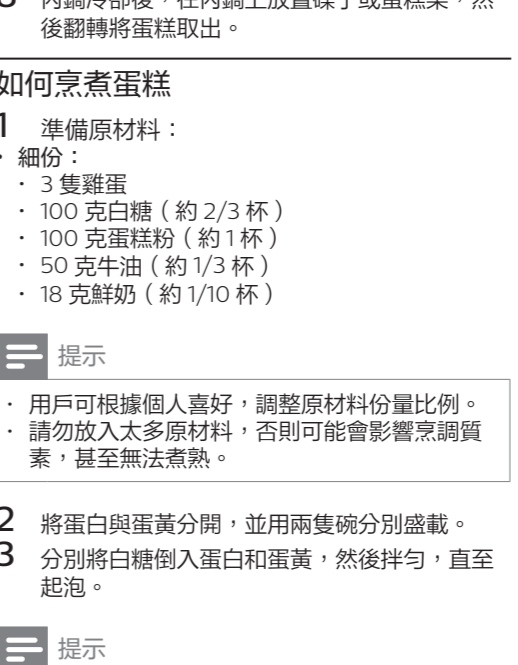

15

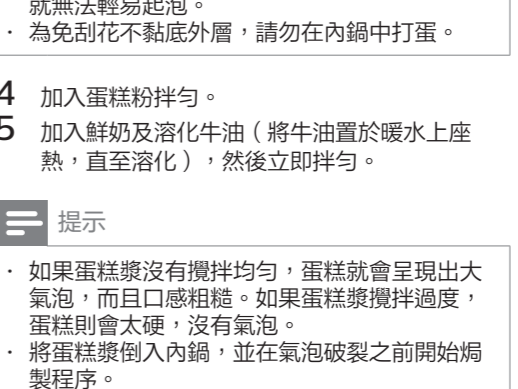

15

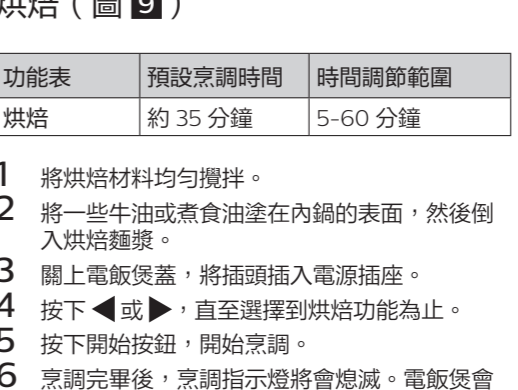

15

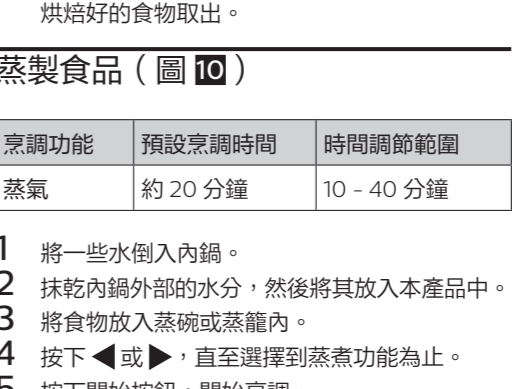

15

- Press <Left> or <Right> to select the cooking time you need.
- Press Start to confirm the cooking time and start the cooking process. The cooking process will be finished by the time when the cooking time has elapsed.

Pre-set time for delayed cooking (Fig 14)

- You can preset the delayed cooking time for some menus. The preset timer is available from 1 hour up to 24 hours.
- The cooking process will be finished by the time the preset time has elapsed. For instance, if the current time is 12:00 (noon time), and you would like the rice ready by 18:00 in the afternoon, you need to set the preset time of 6 hours.
 - If the preset time is shorter than the cooking time, the cooking process will start immediately.
 - The preset timer is not available in the following menus: Reheat, Yogurt and Cake.