

**PHILIPS**

**AC3256**



# User Manual



# Contents

<b>1 Important</b>	<b>2</b>	<b>7 Troubleshooting</b>	<b>18</b>
Safety	2		
<b>2 Your air purifier</b>	<b>5</b>	<b>8 Guarantee and service</b>	<b>20</b>
Product overview	5	Order parts or accessories	20
Controls overview	6	<b>9 Notices</b>	<b>20</b>
<b>3 Getting started</b>	<b>7</b>	Electromagnetic fields (EMF)	20
Install filter	7	Recycling	21
<b>4 Using the appliance</b>	<b>8</b>		
Understand the air quality light	8		
Switch on and off	8		
Change the fan speed	9		
Set the timer	10		
Set the child lock	10		
Use the light on/off function	11		
<b>5 Cleaning</b>	<b>11</b>		
Cleaning schedule	11		
Clean the body of the appliance	11		
Clean the air quality sensor	12		
Clean the pre-filter	12		
<b>6 Replacing the filter</b>	<b>14</b>		
Understand the healthy air protect lock	14		
Replace the filter	14		
Filter force reset	16		
Filter type change	16		

# 1 Important

---

## Safety

Read this user manual carefully before you use the appliance, and save it for future reference.

### Danger

- Do not let water or any other liquid or flammable detergent enter the appliance to avoid electric shock and/or a fire hazard.
- Do not clean the appliance with water, any other liquid, or a (flammable) detergent to avoid electric shock and/or a fire hazard.
- Do not spray any flammable materials such as insecticides or fragrance around the appliance.

### Warning

- Check if the voltage indicated on the appliance corresponds to the local power voltage before you connect the appliance.

- If the power cord is damaged, you must have it replaced by Philips, a service center authorized by Philips, or similarly qualified persons in order to avoid a hazard.
- Do not use the appliance if the plug, the power cord, or the appliance itself is damaged.
- This appliance can be used by children aged from 8 years and above and persons with reduced physical, sensory or mental capabilities or lack of experience and knowledge if they have been given supervision or instruction concerning use of the appliance in a safe way and understand the hazards involved. Child shall not play with the appliance. Cleaning and maintenance shall not be made by children without supervision.
- Do not block the air inlet and outlet, e.g. by placing items on the air outlet or in front of the air inlet.

- Make sure that foreign objects do not fall into the appliance through the air outlet.

### **Caution**

- This appliance is not a substitute for proper ventilation, regular vacuum cleaning, or use of an extractor hood or fan while cooking.
- If the power socket used to power the appliance has poor connections, the plug of the appliance becomes hot. Make sure that you plug the appliance into a properly connected power socket.
- Always place and use the appliance on a dry, stable, level, and horizontal surface.
- Leave at least 20cm free space behind and on both sides of the appliance and leave at least 30cm free space above the appliance.
- Do not place anything on top of the appliance.

- Do not sit or stand on the appliance. Sitting or standing on the appliance may lead to potential injury.
- Do not place the appliance directly below an air conditioner to prevent condensation from dripping onto the appliance.
- Make sure all filters are properly installed before you switch on the appliance.
- Only use the original Philips filters specially intended for this appliance. Do not use any other filters.
- Combustion of the filter may cause irreversible human hazard and/or jeopardize other lives. Do not use the filter as fuel or for similar purpose.
- Avoid knocking against the appliance (the air inlet and outlet in particular) with hard objects.
- Always lift or move the appliance by the handle on top of the appliance.

- Do not insert your fingers or objects into the air outlet or the air inlet to prevent physical injury or malfunctioning of the appliance.
- Do not use this appliance when you have used indoor smoke-type insect repellents or in places with oily residues, burning incense, or chemical fumes.
- Do not use the appliance near gas appliances, heating devices or fireplaces.
- Always unplug the appliance after use and before cleaning or carrying out other maintenance.
- Do not use the appliance in a room with major temperature changes, as this may cause condensation inside the appliance.
- To prevent interference, place the appliance at least 2 meters away from electrical appliances that use airborne radio waves such as TVs, radios, and radio-controlled clocks.
- The appliance is only intended for household use under normal operating conditions.
- Do not use the appliance in wet surroundings or in surroundings with high ambient temperatures, such as the bathroom, toilet, or kitchen.
- The appliance does not remove carbon monoxide (CO) or radon (Rn). It cannot be used as a safety device in case of accidents with combustion processes and hazardous chemicals.
- If you need to move the appliance, disconnect the appliance from the power supply first.
- Do not move the appliance by pulling its power cord.

## 2 Your air purifier

Congratulations on your purchase, and welcome to Philips!

To fully benefit from the support that Philips offers, register your product at [www.philips.com/welcome](http://www.philips.com/welcome).

---

### Product overview

- A Control panel
- B Air quality light
- C Air quality sensors
- D NanoProtect filter HEPA Series 3  
\* (FY3433)
- E NanoProtect filter AC\* (FY3432)
- F Pre-filter
- G Front panel

\* Hereinafter referred to as air purification filter

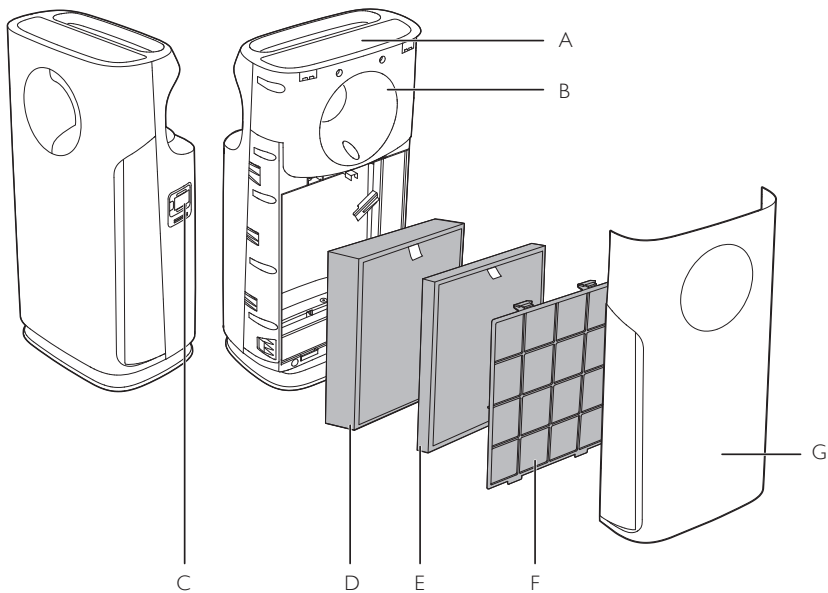

## Controls overview

- H On/Off button
- I Child lock button
- J Light on/off button
- K Display screen
- L Fan speed button
- M Timer button
- N Reset button

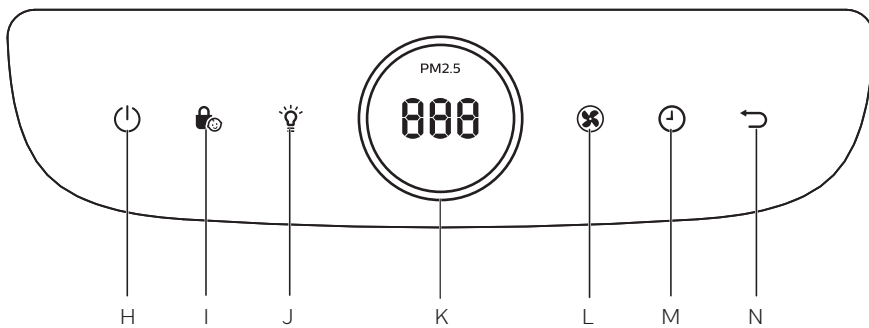



# 3 Getting started

## Install filter

The appliance comes with all filters fitted inside. Remove the packaging of the filters before you can use the appliance. Remove all filters, unpack them, and place them back into the appliance described as follows.

### Note

- Make sure that the side with the tag is pointing towards you.

- 1 Pull the bottom part of the front panel to remove it from the appliance.

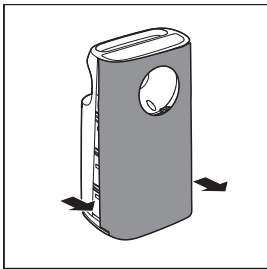

- 2 Press the two clips down and pull the pre-filter towards you.

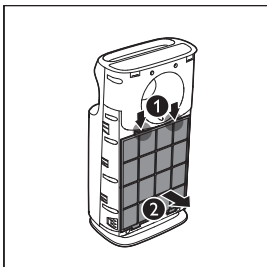

- 3 Remove all filters.

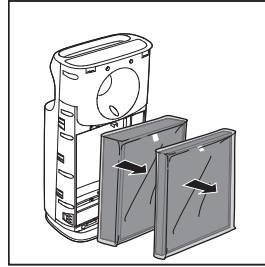

- 4 Remove all packaging materials of the air purification filters.

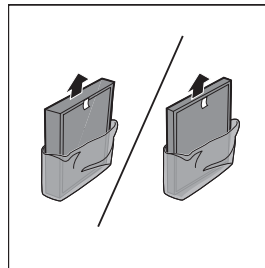

- 5 Put the unpacked air purification filters back into the appliance.

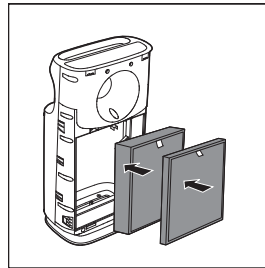

### Note

- Put the thick filter in the appliance first, and then the thinner filter.

- 6 Put the pre-filter back into the appliance.

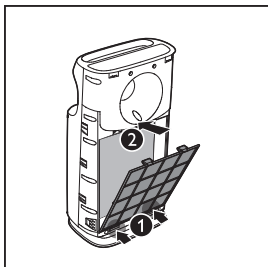

**Note**

- Make sure that the side with the two clips is pointing towards you, and that all hooks of the pre-filter are properly attached to the purifier.

- 7 To reattach the front panel, mount the panel onto the top of the appliance first (1). Then, gently push the panel against the body of the appliance (2).



## 4 Using the appliance

### Understand the air quality light

Air quality light color	Air quality level
Blue	Good
Blue-purple	Fair
Purple-red	Poor
Red	Very Poor

The air quality light automatically goes on when the appliance is switched on, and lights up all colors in sequence. In a short time the air quality sensors select the color that corresponds to the ambient air quality.

### Switch on and off

- 1 Put the plug of the appliance in the power socket.
- 2 Touch  to switch on the appliance.
  - ↳ The appliance operates under the auto mode by default.

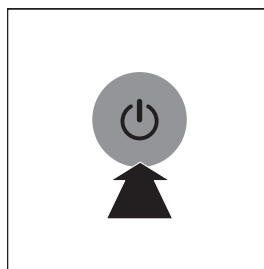

- ↳ After measuring the air quality for a short time, the air quality sensor automatically selects the color of the air quality light.
- ↳ After measuring the particle matters in the air, the appliance shows the PM2.5 level on the screen.

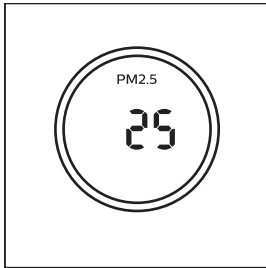

- 3** Touch and hold  for 3 seconds to switch off the appliance.

 **Note**

- After the appliance is switched off by the on/off button , if the plug is still in the power socket, the appliance will operate under the previous settings when it is switched on again.

## Change the fan speed

There are several fan speeds available. You can choose the auto mode, allergen mode, speed 1, 2, 3, 4 or 5.

### Auto (A)

In auto mode, the appliance selects the fan speed according to the ambient air quality.

- Touch the fan speed button  to select auto (A).

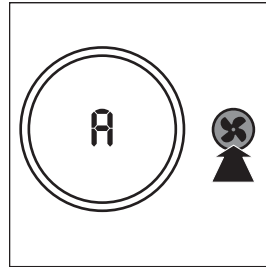

### Allergen mode

The specially designed allergen mode can effectively remove common allergens such as pollen, pet dander and dust mite etc.

- Touch the fan speed button  to select the allergen mode (AL).

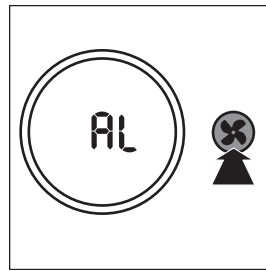

### Sleep mode

In sleep mode, the appliance operates quietly under speed 1. One minute after the sleep mode is selected, the power and light on/off indicators are dimmed, and all the other lights are off.

- Touch the fan speed button  to select the sleep mode (speed 1).

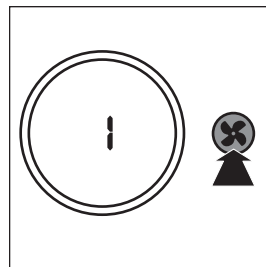

## Manual

- Touch the fan speed button  repeatedly to select the fan speed you need.

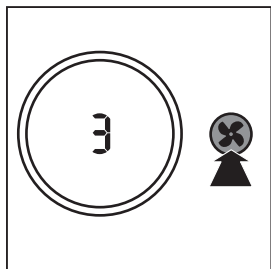

## Set the timer

With the timer, you can let the appliance operate for a set number of hours. When the set time has elapsed, the appliance will automatically switch off.

- Touch the timer button  repeatedly to choose the number of hours you want the appliance to operate.

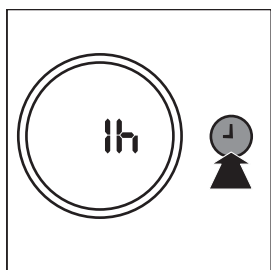



↳ The timer is available from 1 to 24 hours.

To deactivate the timer, touch the timer button  repeatedly until 0h displays on the screen.

## Set the child lock

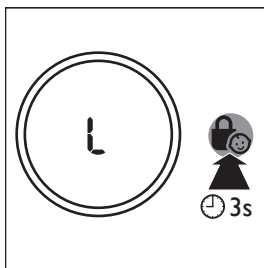
- 1 Touch and hold the child lock button  for 3 seconds to activate child lock.
  - ↳ "L" displays on the screen for 3 seconds.
  - ↳ When the child lock is on, all the other buttons are not responsive.





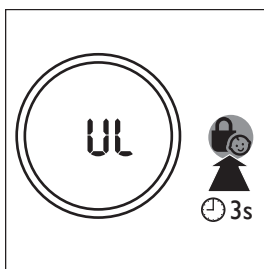

- 2 Touch and hold the child lock button  for 3 seconds again to deactivate child lock.
  - ↳ "UL" displays on the screen for 3 seconds.



---

## Use the light on/off function

With the light on/off button, you can switch on or off the air quality light, the display screen and the function indicators if needed.

- 1 Touch the light on/off button  once, the air quality light will go out.
- 2 Touch the light on/off button  again, the display screen and the function indicators will go out. The power on/off  and light on/off  indicators will still be on, but the lights will be dimmed.
- 3 Touch the light on/off button  for the third time, all lights will be on again.

## 5 Cleaning

### Note

- Always unplug the appliance before cleaning.
- Never immerse the appliance in water or any other liquid.
- Never use abrasive, aggressive, or flammable cleaning agents such as bleach or alcohol to clean any part of the appliance.
- Only the pre-filter is washable. The air purification filter is not washable nor vacuum cleanable.

---

### Cleaning schedule

Frequency	Cleaning method
When necessary	Wipe the surface of the appliance with a soft dry cloth
When <b>FO</b> displays on the screen	Clean the pre-filter
Every two months	Clean the air quality sensors

---

### Clean the body of the appliance

Regularly clean the inside and outside of the appliance to prevent dust from collecting.

- 1 Wipe away dust with a soft dry cloth from the body of the appliance.
- 2 Clean the air outlet with a soft dry cloth.

## Clean the air quality sensor

Clean the air quality sensor every 2 months for optimal functioning of the purifier. Clean them more frequently if you use the purifier in a dusty environment.

### Note

- When the humidity level in the room is very high, it is possible that condensation develops on the air quality sensor. As a result, the air quality light may indicate that the air quality is bad even though it is good. In this case you have to clean the air quality sensor or use one of the manual speed settings.

- Clean the air quality sensor inlet and outlet with a soft brush.

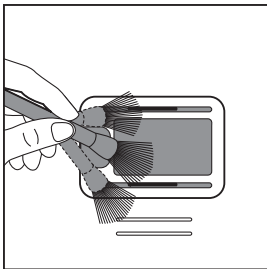

- Remove the air quality sensor cover.

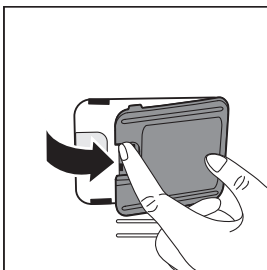

- Clean the air quality sensor, the dust inlet and the dust outlet with a lightly moistened cotton swab.

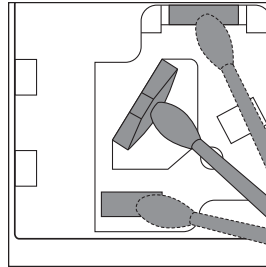

- Dry them with a dry cotton swab.
- Reattach the air quality sensor cover.

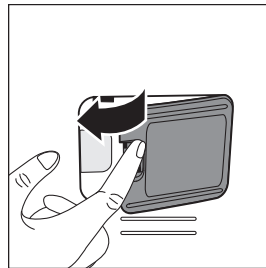

## Clean the pre-filter

Filter alert light status	Follow this
F0 displays on the screen	Clean the pre-filter

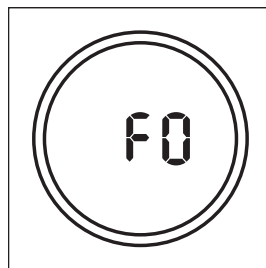

- 1 Pull the bottom part of the front panel to remove it from the appliance.

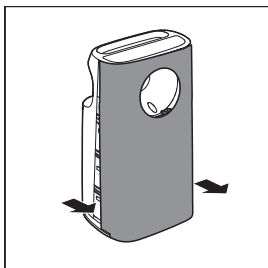

- 2 Press the two clips down and pull the pre-filter towards you.

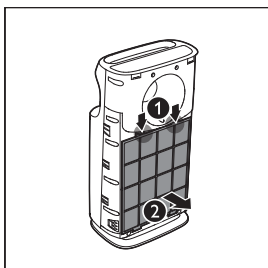

- 3 Wash the pre-filter under a running tap. If the pre-filter is very dirty, use a soft brush to brush away the dust.

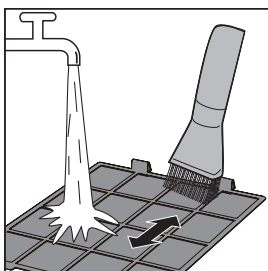

- 4 Air dry the pre-filter.

 Note

- Make sure that the pre-filter is completely dry. If it is still wet, bacteria may multiply in it and shorten the lifetime of the pre-filter.

- 5 Put the pre-filter back into the appliance.

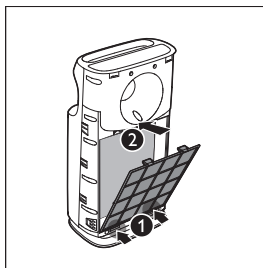

 Note

- Make sure that the side with the two clips is pointing towards you, and that all hooks of the pre-filter are properly attached to the purifier.

- 6 To reattach the front panel, mount the panel onto the top of the appliance first (1). Then, gently push the panel against the body of the appliance (2)



- 7 Touch and hold the reset button  for 3 seconds to reset the pre-filter cleaning time.

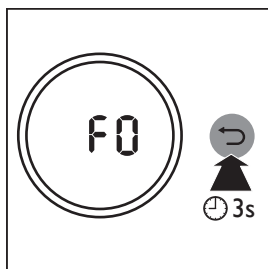

## 6 Replacing the filter

### Understand the healthy air protect lock

This appliance is equipped with the healthy air protect lock to make sure that the air purification filters are in optimal condition when the appliance is operating. When the filters are almost expired, the filter code displays on the screen to indicate that you need to replace the filters.

If the filters are not replaced in 14 days, the appliance will stop operating and get locked.

### Replace the filter



#### Note

- The air purification filters are not washable nor vacuum cleanable.

Filter alert light status	Follow this
A3 displays on the screen	Replace NanoProtect filter HEPA Series 3
C7 displays on the screen	Replace the NanoProtect filter AC
A3 and C7 display on the screen alternately	Replace both filters



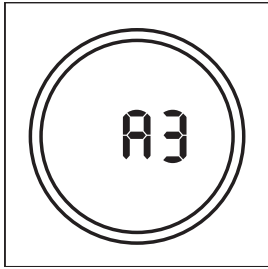

- 1 Take out the expired air purification filter according to the filter code displayed on the screen, and gently put the expired filter into the trash bin.

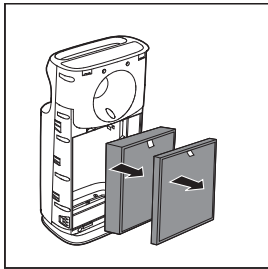

 Note

- Do not touch the pleated filter surface, or smell the filter as it has collected pollutants from the air.

- 2 Remove all packaging material of the new filter.

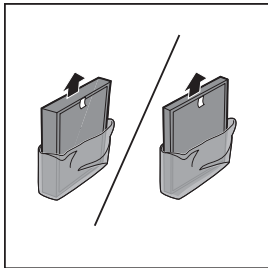

- 3 Place the new filter into the appliance.

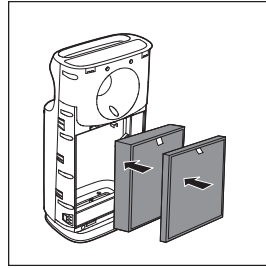

- 4 Touch and hold the reset button  for 3 seconds to reset the filter lifetime counter.

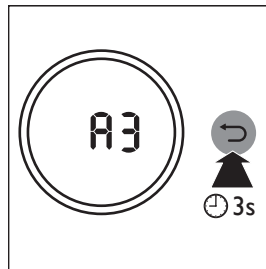



 Note

- Cleanse your hands after changing the filter.

---

## Filter force reset

- 1 Touch  and  simultaneously for 3 seconds to enter the filter force reset mode.
  - ↳ Code (A3) of the NanoProtect filter HEPA Series 3 displays on the screen.

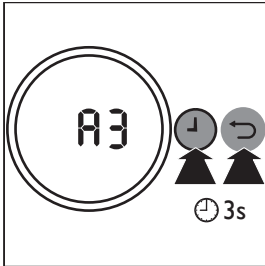

- 2 Touch and hold  for 3 seconds to force reset the filter lifetime of the NanoProtect filter HEPA Series 3.

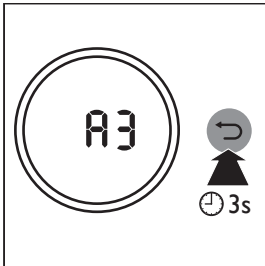

- 3 Code (C7) of the Nanoprotect filter AC displays on the screen after the lifetime of the NanoProtect filter HEPA Series 3 filter HEPA has been reset.

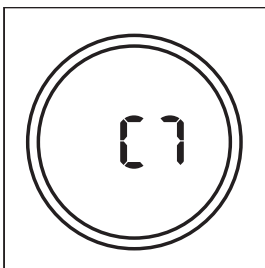

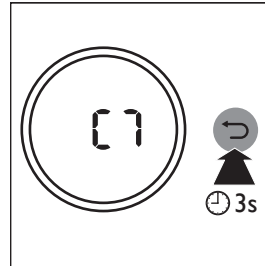

- 4 Touch and hold  for 3 seconds to force reset the filter lifetime of the NanoProtect filter AC and exit the filter force reset mode.



---

## Filter type change

- 1 Touch  and  simultaneously for 3 seconds to enter the filter type change mode.
  - ↳ Code (A3) of the NanoProtect filter HEPA Series 3 displays on the screen.

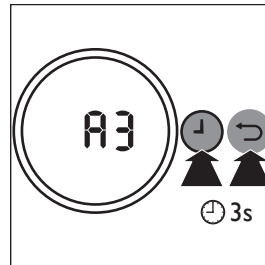

- 2 Touch  to select the filter code of the new filter you will use.

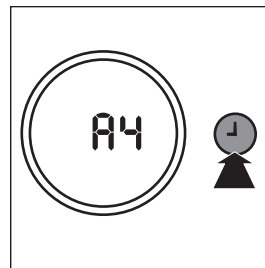

- 3 Touch and hold ↶ for 3 seconds to confirm the filter code of the new filter.

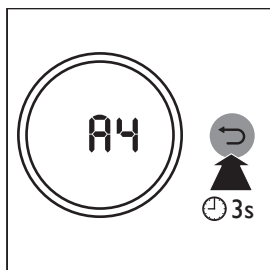

 Note

- After you have selected the filter code of the new filter using the ⏵ button, if you do not touch any other buttons in 10 seconds, the appliance will automatically confirm the filter code of the new filter.

- 4 Code (C7) of the Nanoprotect filter AC displays on the screen after the first filter type has been changed.

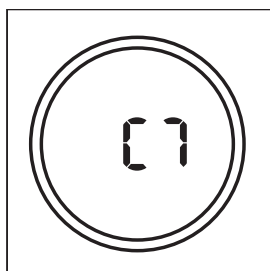

- 5 Touch ⏵ to select the new filter code of the second filter.

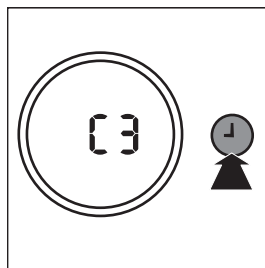

- 6 Touch and hold ↶ for 3 seconds to confirm the filter code of the second filter and exit the filter type change mode.

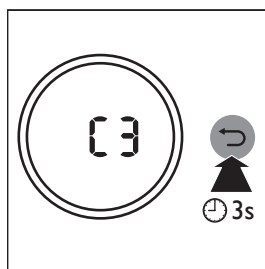

 Note

- After you have selected the filter code of the new filter using the ⏵ button, if you do not touch any other buttons in 10 seconds, the appliance will automatically confirm the filter code of the new filter.



 Note

- Refer to the separate leaflet that comes with the filter for more information on different filter combinations for your choice.

# 7 Troubleshooting

This chapter summarizes the most common problems you could encounter with the appliance. If you are unable to solve the problem with the information below, contact the Consumer Care Center in your country.

Problem	Possible solution
<b>The appliance does not work even though it is plugged in..</b>	The filter replacement code has been displaying on the screen but you have not replaced the corresponding filter yet. The appliance will be locked if you keep using the expired filter. In this case, replace the filter and reset the filter lifetime counter.
<b>The appliance does not work even though it is switched on.</b>	<ul style="list-style-type: none"><li>• The appliance is working but the buttons are not responsive. Check if the child lock is on.</li><li>• The filter replacement code has been on continuously but you have not replaced the corresponding filter, and the appliance is now locked. In this case, replace the filter and reset the filter lifetime counter.</li></ul>
<b>The airflow that comes out of the air outlet is significantly weaker than before.</b>	<ul style="list-style-type: none"><li>• The pre-filter is dirty. Clean the pre-filter (see chapter "Cleaning").</li></ul>
<b>The air quality does not improve, even though the appliance has been operating for a long time.</b>	<ul style="list-style-type: none"><li>• One of the filters has not been placed in the appliance. Make sure that all filters are properly installed in the following order, starting with the innermost filter: 1) NanoProtect filter HEPA Series 3; 2) NanoProtect filter AC; 3) pre-filter.</li><li>• The air quality sensor is wet. The humidity level in your room is high and causes condensation. Make sure that the air quality sensor is clean and dry (see chapter "Cleaning").</li></ul>
<b>The color of the air quality light always stays the same.</b>	The air quality sensor is dirty. Clean the air quality sensor (see chapter "Cleaning").

Problem	Possible solution
<p>The appliance produces a strange smell.</p>	<p>The first few times you use the appliance, it may produce a plastic smell. This is normal. However, if the appliance produces a burnt smell even if removing filters, contact your Philips dealer or an authorized Philips service center. The appliance may also produce an unpleasant smell when the filter is dirty. In this case, clean or replace the filter concerned.</p>
<p>The appliance is extra loud.</p>	<p>If the appliance is too loud, you can change the fan speed to a lower fan speed level. When using the appliance in a bedroom at night, choose the sleep mode.</p>
<p>The appliance still indicates that I need to replace a filter, but I already did.</p>	<p>Perhaps you did not reset the filter lifetime counter. Plug in the appliance, touch  to switch on the appliance, and touch and hold the reset button  for 3 seconds.</p>
<p>Error code "Er" displays on the screen.</p>	<p>The hall sensor is not working properly. Remove and then reattach the front panel. If the error code "Er" still exists, contact the Consumer Care Center in your country.</p>
<p>Error codes "E1", "E2", "E3" or "E4" displays on the screen.</p>	<p>The appliance has malfunctions. Contact the Consumer Care Center in your country.</p>

## 8 Guarantee and service

If you need information or if you have a problem, please visit the Philips website at [www.philips.com](http://www.philips.com) or contact the Philips Consumer Care Center in your country (you find its phone number in the worldwide guarantee leaflet). If there is no Consumer Care Centre in your country, go to your local Philips dealer.

---

### Order parts or accessories

If you have to replace a part or want to purchase an additional part, go to your Philips dealer or visit [www.philips.com/support](http://www.philips.com/support).

If you have problems obtaining the parts, please contact the Philips Consumer Care Center in your country (you can find its phone number in the worldwide guarantee leaflet).

## 9 Notices

---

### Electromagnetic fields (EMF)

This Philips appliance complies with all applicable standards and regulations regarding exposure to electromagnetic fields.

---

### Compliance with EMF

Philips Domestic Appliances Holding B.V. manufactures and sells many products targeted at consumers, which, like any electronic apparatus, in general have the ability to emit and receive electromagnetic signals.

One of Philips' leading Business Principles is to take all necessary health and safety measures for our products, to comply with all applicable legal requirements and to stay well within the EMF standards applicable at the time of producing the products.

Philips is committed to develop, produce and market products that cause no adverse health effects. Philips confirms that if its products are handled properly for their intended use, they are safe to use according to scientific evidence available today.

Philips plays an active role in the development of international EMF and safety standards, enabling Philips to anticipate further developments in standardization for early integration in its products.

---

## Recycling

Do not throw away the product with the normal household waste at the end of its life, but hand it in at an official collection point for recycling. By doing this, you help to preserve the environment.

Follow your country's rules for the separate collection of electrical and electronic products. Correct disposal helps prevent negative consequences for the environment and human health.



© 2021 Philips Domestic Appliances Holding B.V.  
All rights reserved.

3000 059 82641

