



PHILIPS

Super automatic
espresso machine

3100 series

EP3559, EP3558
EP3551, EP3550

EN USER MANUAL

DE BENUTZERHANDBUCH

ES MANUAL DEL USUARIO

FR MODE D'EMPLOI

IT MANUALE UTENTE

NL GEBRUIKSAANWIJZING

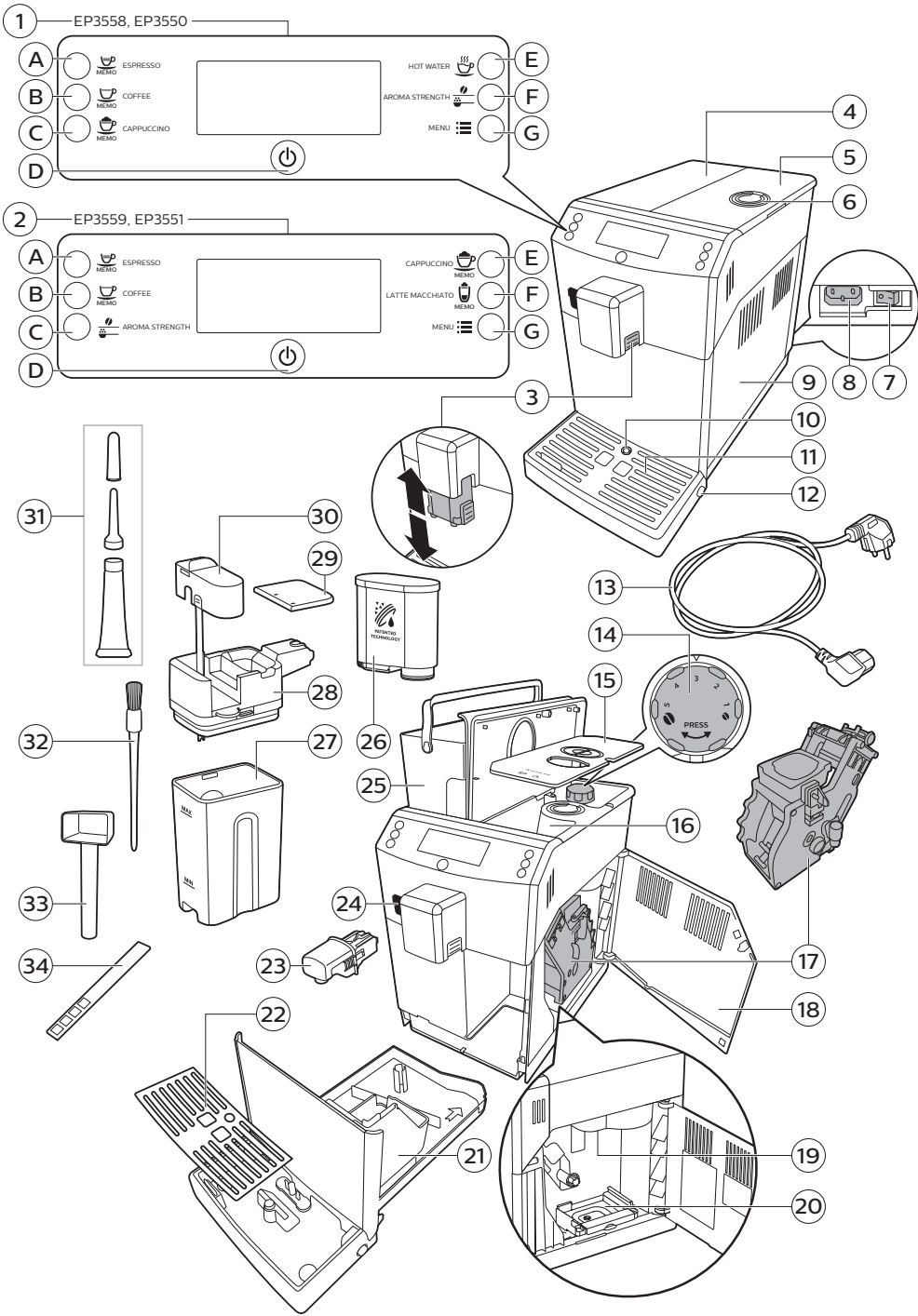

Contents

Machine overview	5
Introduction	5
First installation	6
AquaClean filter	6
Activating the AquaClean filter	6
Replacing the AquaClean filter	7
Replacing the AquaClean filter after 8 filters were used	8
Measuring the water hardness	8
Control panel and display	9
One-touch beverage buttons	9
Navigation buttons	9
MENU button	9
AROMA STRENGTH button	10
Brewing coffee	10
Brewing coffee with beans	10
Brewing coffee with pre-ground coffee	10
Milk froth and hot water	11
Dispensing hot water	11
Brewing milk-based coffee beverages and milk froth	11
Adjusting volume and taste	12
Adjusting coffee and milk volume	12
Adjusting coffee strength	12
Adjusting grinder settings	12
Cleaning and maintenance	13
Cleaning table	13
Cleaning the brew group	14
Cleaning the brew group under the tap	14
Cleaning the brew group with coffee oil remover tablets	15
Reinserting the brew group	15
Lubrication	16
Cleaning the milk carafe	17
Carafe quick clean	17
Thorough cleaning of the milk carafe	17
Weekly cleaning of the milk carafe	17
Disassembling the milk dispensing spout	17
Reassembling the milk carafe	18
Monthly cleaning of the milk carafe	18
Descaling procedure	19
What to do if the descaling procedure is interrupted	21
Warning icons and error codes	22
Meaning of the warning icons	22
Meaning of the error codes	22
Troubleshooting	23

Machine overview

1	User interface (EP3558, EP3550 only)	11	Drip tray
1A	ESPRESSO button	12	Drip tray release button
1B	COFFEE button	13	Cord
1C	CAPPUCCINO button	14	Grind setting knob
1D	Standby button	15	Cover of bean hopper
1E	HOT WATER button	16	Bean hopper
1F	AROMA STRENGTH button	17	Brew group
1G	MENU button	18	Inside of service door with contact information
2	User interface (EP3559, EP3551 only)	19	Coffee exit duct
2A	ESPRESSO button	20	Coffee residues drawer
2B	COFFEE button	21	Coffee grounds container
2C	AROMA STRENGTH button	22	Drip tray cover
2D	Standby button	23	Hot water dispensing spout
2E	CAPPUCCINO button	24	Opening for hot water dispensing spout
2F	LATTE MACCHIATO button	25	Water tank
2G	MENU button	26	AquaClean filter
3	Adjustable coffee dispensing spout	27	Milk container
4	Lid of water tank	28	Milk dispensing unit
5	Lid of bean hopper	29	Lid of milk dispensing unit
6	Lid of pre-ground coffee compartment	30	Milk dispensing spout
7	Main switch	31	Grease tube with application tip and cap
8	Socket for cord	32	Cleaning brush
9	Service door	33	Measuring scoop
10	'Drip tray full' indicator	34	Water hardness test strip
11	Drip tray		

Introduction

Congratulations on your purchase of a Philips full-automatic coffee machine! To fully benefit from the support that Philips offers, please register your product at www.philips.com/coffee-care.

Read the separate safety booklet carefully before you use the machine for the first time and save it for future reference.

To help you get the best out of your coffee machine, Philips offers full support in 4 different ways:

- The separate quick start guide for first installation and first use.
- This user manual for more detailed information on how to use the machine, how to keep it clean, how to descale it and how to solve problems.
- This is the QR code. Scan this code to access instruction videos on how to brew the best coffees, how to clean the machine and for a list of frequently asked questions. (www.philips.com/coffee-care)
- The separate booklet with important safety information.



First installation

For first installation, follow the instructions on the separate quick start guide.

Note: This machine has been tested with coffee. Although it has been carefully cleaned, there may be some coffee residues left. We guarantee, however, that the machine is absolutely new.

Note: You can install the AquaClean filter during the first installation procedure (see separate quick start guide). If you skip installation of the AquaClean filter at first use, you can install it later by entering the menu (see 'Activating the AquaClean filter').

AquaClean filter

The AquaClean filter is designed to reduce limescale deposits in your coffee machine and provide filtered water to preserve the aroma and flavor of each cup of coffee. If you use a series of 8 AquaClean filters as indicated in this user manual, you don't have to descale your machine for up to 5000 cups.

Note: Your machine has to be completely limescale-free before you start to use the AquaClean filter. If you did not activate the filter during first installation, you need to descale the machine before you activate the filter.

Activating the AquaClean filter

Note: Always confirm activation of the AquaClean filter in the machine menu as described below. You also need to do this after replacing the AquaClean filter. By activating the AquaClean filter in the machine menu, the machine monitors the number of filters used. When the filter has been replaced 8 times, the machine reminds you to descale it.

- 1 For instructions on how to place the AquaClean filter in the water tank, see the separate quick start guide.

Note: Shake the AquaClean filter for about 5 seconds, immerse it upside down in a jug with cold water and wait until no more air bubbles come out.

- 2 Press the MENU button, select MENU and press the OK button to confirm. Scroll to AQUACLEAN FILTER. Press the OK button to confirm.
 - The display shows the number of AquaClean filters that have been installed previously from 0 to 8 filters.



- 3 Select ON on the display, press the OK button to confirm.

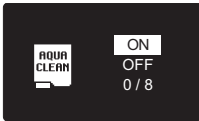

- 4 The display automatically updates the number of filters used.



- Then the 'machine ready' screen appears with the AquaClean 100% icon to indicate that the filter has been installed.

- 5 Dispense 2 cups of hot water (0.5 l) to complete the activation. Discard this water.



Replacing the AquaClean filter

Note: Replace the AquaClean filter as soon as the capacity has dropped to 0% and the filter icon flashes quickly. Replace the AquaClean filter at least every 3 months, even if the machine has not yet indicated that replacement is required.

Tip: We advise you to buy a new filter when the capacity has dropped to 10% and the filter icon starts flashing slowly. This ensures that you can replace the filter when the capacity has dropped to 0%.

- 1 Take out the AquaClean filter and replace it by a new AquaClean filter (also see the separate quick start guide).
- 2 Press the MENU button, scroll to AQUACLEAN FILTER and press the OK button to confirm.





- The display asks if you want to activate a new filter.
- 3 Press the OK button to confirm.



- The display automatically updates the number of filters used.
- 4 Dispense 2 cups of hot water (0.5 l) to complete the activation. Discard this water.

Replacing the AquaClean filter after 8 filters were used

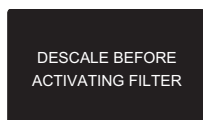

- 1 When the filter icon starts flashing on the display, press the MENU button, scroll to AQUACLEAN FILTER and press the OK button to confirm.
 - The display tells you that you need to descale the machine before activating the new filter.
- 2 Press the OK button to start the descaling procedure.
 - Press the escape button several times to leave the filter menu if you do not want to descale right away.
- 3 At the end of the descaling procedure, the display asks you if you want to install the AquaClean filter.
 - Follow the steps in 'Replacing the AquaClean filter'.

Measuring the water hardness

Note: If you have installed the AquaClean filter, you do not need to set the water hardness.

To be able to adjust the machine settings to the water in your region, please measure the water hardness with the water hardness test strip supplied. The default water hardness of the machine is set to the highest level (4). If the measured water hardness is different, adjust the setting in the machine menu.

- 1 Immerse the water hardness test strip (supplied with the machine) in tap water for 1 second.
- 2 Remove the water hardness test strip and wait for 1 minute.
- 3 Check how many squares have turned red and check the water hardness in the table below.

number of red squares	value to be set	water hardness
■ ■ ■ ■	1	very soft water
■ ■ ■ □	2	soft water
■ ■ ■ ■	3	hard water
■ ■ ■ ■	4	very hard water

- 4 Press the MENU button, select menu and scroll to select water hardness. Select the preferred water hardness setting and press the OK button to confirm.

Control panel and display

This espresso machine has a self-explaining display for easy use. Read the sections below for a quick explanation of the buttons.

One-touch beverage buttons

Use the one-touch beverage buttons to quickly prepare one of the preset beverages: ESPRESSO, COFFEE, CAPPUCCINO, LATTE MACCHIATO (EP3559, EP3551 only) and HOT WATER (EP3558, EP3550 only).

Navigation buttons

Some of the one-touch beverage buttons have a double function; use these buttons to navigate through the menu.

EP3558, EP3550



➔ ESPRESSO button = Escape button: press this button to return to the main menu.



HOT WATER button = Up button: press this button to scroll up through the display.



✓ CAPPUCCINO button = OK button: press this button to select, confirm or stop a function.



MENU button = Down button: press this button to scroll down through the display menu.

EP3559, EP3551



➔ ESPRESSO button = Escape button: press this button to return to the main menu.



CAPPUCCINO button = Up button: press this button to scroll up through the display.



✓ AROMA STRENGTH button = OK button: press this button to select, confirm or stop a function.



MENU button = Down button: press this button to scroll down through the display menu.

MENU button

Use the MENU button to prepare other drinks, like hot water (EP3558, EP3510 only) and frothed milk. You can also use the MENU button to change the following settings:

- Coffee temperature
- Stand-by time: this is the time after which the machine goes into standby mode.
- Display contrast
- Water hardness: to be able to adjust the machine settings to the water in your region, please measure the water hardness.

- To activate the AquaClean filter
- To start descaling
- To restore to the factory settings

AROMA STRENGTH button

Use the AROMA STRENGTH button to adjust the coffee strength or to brew pre-ground coffee.

Brewing coffee

Brewing coffee with beans

Caution: Only use espresso beans. Never put ground coffee, unroasted coffee beans or caramelized coffee beans in the bean hopper, as this may cause damage to the machine.

To brew coffee, follow the instructions on the separate quick start guide.

To brew two cups of espresso, press the ESPRESSO button twice. The machine automatically carries out two grinding cycles in sequence.

Note: Using the cover of the bean hopper helps to keep the beans fresh.

Brewing coffee with pre-ground coffee

When you brew coffee with pre-ground coffee, use the measuring scoop supplied to put the correct dose in the pre-ground coffee compartment.

- 1 Open the lid of the pre-ground coffee compartment.
- 2 Pour **one** measuring scoop of pre-ground coffee into the pre-ground coffee compartment and close the lid.

Caution: Do not put any other substance than pre-ground coffee in the pre-ground coffee compartment, as this may damage the machine.

- 3 Place a cup under the coffee dispensing spout.
- 4 Press the AROMA STRENGTH button and select the pre-ground coffee brewing function.
- 5 Press the ESPRESSO button.

The machine automatically starts brewing the selected beverage.

Note: With pre-ground coffee you can only brew one coffee at a time.

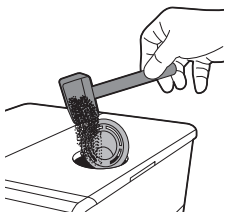

Milk froth and hot water

Dispensing hot water

Caution: Steam and hot water may spray out of the hot water dispensing spout when brewing starts. Wait until brewing has ended before you remove the hot water dispensing spout.

- 1 Insert the hot water dispensing spout.
- 2 EP3559, EP3551 only: Press the MENU button. Select DRINKS, confirm and scroll to select HOT WATER.

EP3558, EP3550 only: Press the one-touch HOT WATER button to dispense hot water.

Caution: Only select HOT WATER in the menu when the hot water dispensing spout is installed.

- 3 Press the OK button to confirm. The display reminds you to install the hot water dispensing spout; press the OK button to confirm. The machine starts dispensing hot water.
- 4 To stop dispensing hot water, press the OK button.

Brewing milk-based coffee beverages and milk froth

Note: For more information on how to use the milk carafe, read the separate quick start guide or scan the QR code to access the dedicated website for instruction videos (www.philips.com/coffee-care).

Caution: Make sure that the milk carafe is installed and the milk froth dispensing spout is open before you select a milk-based coffee beverage or milk froth. If the milk carafe is not installed correctly, steam and hot milk may spray out of the milk froth dispensing spout.

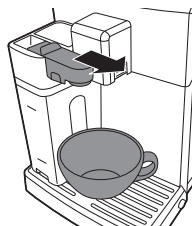

- 1 Place a cup under the open milk froth dispensing spout.
- 2 Choose your milk-based beverage.
 - Press the one-touch CAPPUCCINO button or LATTE MACCHIATO button (EP3559, EP3551 only) to brew one of these milk-based beverages right away.
 - Press the MENU button, choose DRINKS and scroll down through the drinks to select MILK FROTH.
 - The machine reminds you that you have to install the milk carafe and open the milk froth dispensing spout.
- 3 The machine first dispenses a preset volume of frothed milk into the cup or glass and then dispenses a preset volume of coffee.
 - To stop dispensing milk or coffee, press the OK button.
- 4 After brewing milk-based coffee beverages, the display asks you if you want to perform the quick clean procedure for the milk carafe. You have 30 seconds to activate the quick clean procedure.

Adjusting volume and taste

Adjusting coffee and milk volume

You can adjust the volume of the beverage brewed according to your taste and to the size of the cups.

Note: We advise you to use glass cups or cups with a ceramic-coated rim.

- 1 To adjust the espresso volume, press and hold the ESPRESSO button until the display shows the MEMO icon.
 - The machine enters the programming phase and starts to brew the selected beverage.
- 2 Press the OK button when the cup contains the desired amount of espresso.
 - The tick on the display shows that the button is programmed: every time it is pressed, the machine brews the set espresso volume.

Note: To set the volume of coffee, cappuccino, latte macchiato (EP3559, EP3551 only), follow the same procedure: press and hold the button of the beverage and press the OK button when the cup contains the desired amount of coffee or milk. Make sure that the milk carafe is in place and that the milk spout is open.

Adjusting coffee strength

To change the coffee strength, press the AROMA STRENGTH button. Each time you press the AROMA STRENGTH button, the aroma strength changes by one degree. The display shows the chosen strength, which is only saved if you brew a coffee.

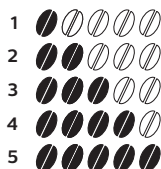

- 1 Very mild
- 2 Mild
- 3 Regular
- 4 Strong
- 5 Very strong

Note: After adjusting the coffee strength, the display shows the main menu again and saves the chosen aroma strength when you brew a coffee.

Adjusting grinder settings

You can adjust the grinder settings by using the grind setting knob inside the bean container.

Note: You can only adjust the grind settings when the machine is grinding coffee beans.

Caution: Do not turn the grind setting knob more than one notch at a time to prevent damage to the grinder.

- 1 Place a cup under the coffee dispensing spout.
- 2 Open the lid of the bean hopper.

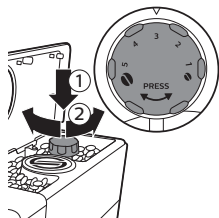

- 3 Press the ESPRESSO button.
- 4 When the grinder starts grinding, press down the grind setting knob and turn it to the left or right.
 - There are 5 different grind settings you can choose from. The lower the setting, the stronger the coffee.

Cleaning and maintenance

Note: Consult the table below for when and how to clean all detachable parts of the machine. For more detailed information on how to clean the brew group and how to descale the machine, read the corresponding chapters below and visit the dedicated website www.philips.com/coffee-care.

Cleaning table

Part description	When to clean	How to clean
Brew group	Weekly	Remove the brew group and clean it under the tap (see 'Cleaning the brew group under the tap').
	Depending on the type of usage	Lubricate the brew group (see 'Lubrication').
	Monthly	Clean the brew group with Philips/Saeco coffee oil remover tablets.
Milk carafe	After every use	Perform the QUICK CARAFE CLEAN as indicated on the machine after preparing a milk-based beverage.
	Daily	Clean the milk carafe thoroughly (see 'Thorough cleaning of the milk carafe').
	Weekly	Disassemble the milk carafe and clean all parts under the tap (see 'Weekly cleaning of the milk carafe').
	Monthly	Use Philips/Saeco milk circuit cleaner for this cleaning cycle (see 'Monthly cleaning of the milk carafe').
Drip tray	As soon as the red 'drip tray full' indicator pops up through the drip tray.	Empty the drip tray and clean it under the tap.
Coffee grounds container	When it suits you	Empty the coffee grounds container and clean it under the tap. Make sure the machine is switched on while you empty and clean the coffee grounds container.

Part description	When to clean	How to clean
Water tank	When it suits you	Clean it under the tap.
Pre-ground coffee compartment/coffee exit duct	Weekly	Clean the top part with a spoon handle as shown below.

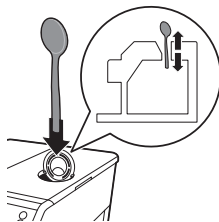

Tip: Write down the dates on which you have cleaned the different components on the calendar in the back of this user manual.

Cleaning the brew group



Note: Scan the QR code or visit www.philips.com/coffee-care for support videos on how to remove and clean the brew group.

Caution: Do not clean the brew group in the dishwasher and do not use washing-up liquid or a cleaning agent to clean it. This may cause the brew group to malfunction and may have a negative effect on the coffee taste.

Cleaning the brew group under the tap

- 1 Switch off the machine and unplug it.
- 2 Remove the drip tray with the coffee grounds container.
- 3 Open the service door.
- 4 Press the PUSH button (1) and pull at the grip of the brew group to remove it from the machine (2).

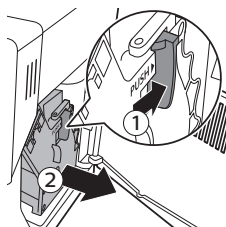

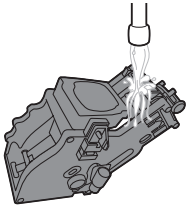

- 5 Rinse the brew group thoroughly with lukewarm water. Clean the upper filter carefully.
- 6 Let the brew group air-dry.

Note: Do not dry the brew group with a cloth to prevent fibers from collecting inside the brew group.

Cleaning the brew group with coffee oil remover tablets

Caution: Only use Philips/Saeco coffee oil remover tablets for cleaning. They do not have a descaling function.

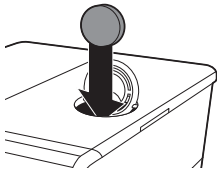

- 1 Place a container under the coffee dispensing spout.
- 2 Press the AROMA STRENGTH button and select pre-ground coffee.
- 3 Put a coffee oil remover tablet in the pre-ground coffee compartment.
- 4 Press the COFFEE button. The machine dispenses water from the coffee dispensing spout.
- 5 When the progress bar has reached the middle, set the main switch on the back of the machine to OFF.
- 6 Let the coffee oil remover solution act for approximately 15 minutes.
- 7 Set the main switch to ON. Press the standby button.
- 8 Wait until the machine performs an automatic rinsing cycle.
- 9 Perform the 'Weekly cleaning of the brew group' procedure.
- 10 Remove the drip tray with the coffee grounds container and empty them. Then place them back into the machine.
- 11 Press the AROMA STRENGTH button and select pre-ground coffee.
- 12 Press the COFFEE button. The machine dispenses water from the coffee dispensing spout.
- 13 Repeat steps 11 and 12 twice. Discard the dispensed water.

Reinserting the brew group

- 1 Before you slide the brew group back into the machine, make sure the two yellow reference signs on the side match. If they do not match, perform the following step:

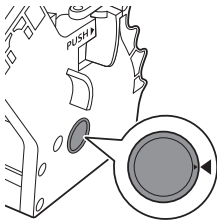

- Make sure the lever is in contact with the base of the brew group.
- 2 Make sure that the yellow locking hook of the brew group is in the correct position.

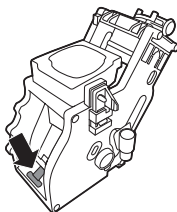

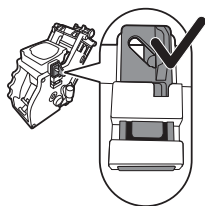

- To position the hook correctly, push it upwards until it is in uppermost position.

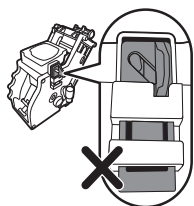

- The hook is not positioned correctly if it is still in bottommost position.

- 3 Slide the brew group back into the machine along the guiding rails on the sides until it locks into position with a click.

Caution: Do not press the PUSH button.

- 4 Close the service door.

Lubrication

For optimal performance of the machine, you have to lubricate the brew group. See table below for the lubrication frequency. For support videos visit our website: www.philips.com/coffee-care.

Usage frequency

Nr of beverages brewed daily

Lubrication frequency

Low	1-5	Every 4 months
Normal	6-10	Every 2 months
Heavy	>10	Every month

- 1 Switch off the appliance and unplug it.
- 2 Remove the brew group and rinse it under a lukewarm tap (see 'Cleaning the brew group under the tap'). Then let it air-dry.
- 3 Apply a thin layer of grease around the shaft in the bottom of the brew group.

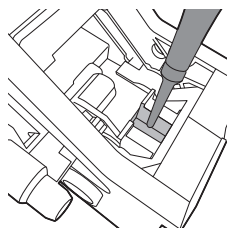

- 4 Apply a thin layer of grease to the rails on both sides (see figure).
- 5 Reinsert the brew group (see 'Reinserting the brew group').

You can use the grease tube multiple times.

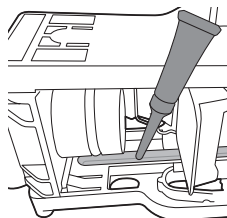

Cleaning the milk carafe

Carafe quick clean

After preparing a milk-based beverage, the carafe cleaning icon appears on the display.

- 1 When the carafe cleaning icon appears on the display, press the OK button if you want to perform a cleaning cycle. You have 30 seconds to activate the quick clean procedure. Press the escape button if you do not want to perform the quick clean procedure.
- 2 Remove the cup with the beverage and place an empty cup under the milk dispensing spout.

Note: Make sure the milk dispensing spout is pulled out.

- 3 Press the OK button to start dispensing hot water.

Thorough cleaning of the milk carafe

To clean the milk carafe thoroughly, you have to do the following regularly:

- 1 Remove the lid of the milk dispensing unit.
- 2 Lift the milk dispensing spout out of the milk dispensing unit.
- 3 Remove the milk tube from the milk dispensing spout.
- 4 Rinse the milk tube and milk dispensing spout with lukewarm water thoroughly.

Weekly cleaning of the milk carafe

The milk dispensing spout consists of 5 components. Disassemble all components once a week and clean them under the tap. You can also clean all components, except for the milk container, in the dishwasher.

- 1 Milk tube
- 2 Rubber support
- 3 Milk frother
- 4 Milk frother connector
- 5 Housing of milk dispensing spout

Disassembling the milk dispensing spout

- 1 Press the release buttons on both sides of the top of the milk dispensing unit (1) and lift the top off the milk container (2).

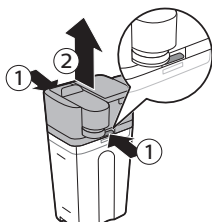
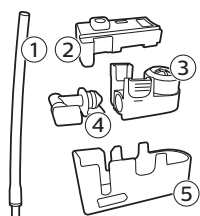
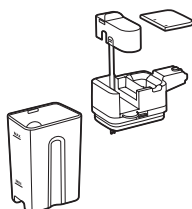
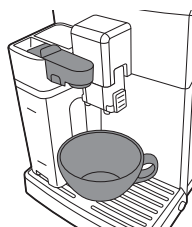

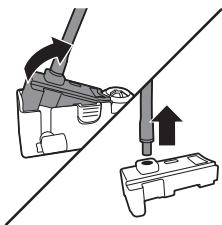

- 2 Turn the milk dispensing unit upside down and hold it firmly in your hand. Pull the milk tube off the rubber support.

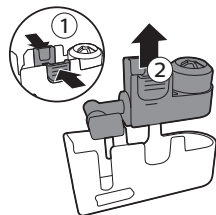

- 3 Press the release buttons on the milk frother and remove the milk frother from the the rubber support.

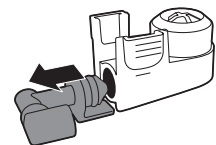

- 4 Pull the milk frother connector out of the milk frother.
- 5 Rinse all components under a lukewarm tap.

Reassembling the milk carafe

- 1 To reassemble the milk froth dispensing spout, follow steps 2 to 4 of 'Disassembling the milk froth dispensing spout' in reverse order.
- 2 Place the milk froth dispensing spout back into the top of the milk carafe.
- 3 Place the top of the milk carafe back onto the milk carafe.

Note: Before you place the milk froth dispensing spout back into the top of the milk carafe, move the pin inside the top to the correct position. If this pin is not in the correct position, you cannot place the milk froth dispensing spout back into the top of the milk carafe.

Monthly cleaning of the milk carafe

Only use Philips/Saeco milk circuit cleaner for this cleaning cycle.

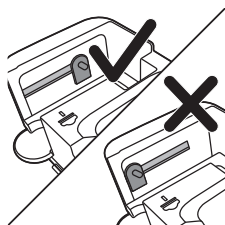



- 1 Pour the contents of the milk circuit cleaner sachet in the milk carafe. Then fill the milk carafe with water up to the MAX level indication.
 - 2 Insert the milk carafe into the machine and place a container under the milk dispensing spout.
 - 3 Press the MENU button, select DRINKS and scroll to MILK FROTH. Press the OK button to start dispensing the cleaning solution.
 - 4 Repeat step 3 until the milk carafe is empty.
 - 5 When the carafe is empty, remove the container and the milk carafe from the machine.
 - 6 Rinse the milk carafe thoroughly and fill it with fresh water up to the MAX level indication.
 - 7 Insert the milk carafe into the machine.
 - 8 Place the container under the milk dispensing spout.
 - 9 Press the MENU button and select MILK FROTH in the DRINKS menu to start the carafe rinsing cycle.
 - 10 Repeat step 9 until the milk carafe is empty.
- Note:** Never drink the solution dispensed during this step.
- 11 Repeat steps 6-10.
 - 12 When the machine stops dispensing water, the cleaning cycle is finished.
 - 13 Disassemble all the components and rinse them under a lukewarm tap.

Descaling procedure

When the display shows START CALC CLEAN, you need to descale the machine. If you do not descale the machine when this message appears on the display, the machine will eventually stop working properly. In that case, repairs are not covered by the warranty.

Only use Philips/Saeco descaling solution to descale the machine. The use of other products may damage the machine and leave residues in the water. You can buy descaling solution in the online shop at www.philips.com/coffee-care.

The descaling procedure lasts 30 minutes and consists of a descaling cycle and a rinsing cycle. You can pause the descaling or rinsing cycle by pressing the escape button. To continue the descaling or rinsing cycle, press the OK button.

Note: Do not remove the brew group during the descaling procedure.

Warning: Do not drink the descaling solution or the water dispensed during the descaling procedure.

- 1 Remove the drip tray and the coffee grounds container, empty and clean them and put them back into place.
- 2 Place a large container (1.5 l) under the coffee dispensing spout.

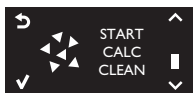

- 3 When the display shows START CALC CLEAN, press the OK button to start the descaling procedure. Remove the hot water dispensing spout if present.



- The display reminds you that you have to insert the carafe. Fill the milk carafe with water up to the MIN level indication. Insert the milk carafe into the machine and open the milk froth dispensing spout.



- The display reminds you that you have to open the milk dispensing spout.



- The display reminds you that you have to remove the AquaClean filter.

Note: You can press the escape button if you want to start the descaling procedure later. To perform the descaling procedure later, press the MENU button, select MENU and scroll to select DESCALING. Press OK to confirm.

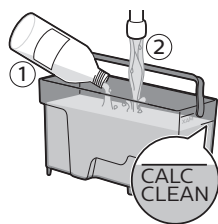

- 4 Pour the descaling solution into the water tank. Fill the water tank with fresh water up to the CALC CLEAN level indication. Place the water tank back into the machine. Press the OK button to confirm.
 - The first phase of the descaling procedure starts. The machine starts dispensing the descaling solution at intervals.
 - The display shows the descaling icon, the phase indication and the duration. This first phase takes 20 minutes.
- 5 Let the machine dispense the descaling solution until the water tank is empty.
- 6 Remove the water tank and rinse it.
- 7 Fill the water tank with fresh water up to the CALC CLEAN level indication. Place the water tank back into the machine.
- 8 Remove and rinse the milk carafe. Fill the milk carafe with water up to the MIN level indication. Insert the milk carafe into the machine and open the milk froth dispensing spout.
- 9 Remove and empty the container and place it back under the coffee dispensing spout. Press OK to confirm.
- 10 The second phase of the descaling procedure starts, which is the rinsing cycle. This phase takes 3 minutes. The display shows the rinsing icon and the duration of the phase.

Note: If the water tank is not filled up to the CALC CLEAN level, the machine may require another rinsing cycle.

- 11 Wait until the machine stops dispensing water. The descaling procedure is finished when the tick appears on the display.
- 12 Press the OK button to exit the descaling cycle. The machine starts heating up and performs the automatic rinsing cycle.
- 13 Remove and empty the container.
- 14 Perform the 'Weekly cleaning of the milk carafe' procedure to clean the milk carafe after descaling.
- 15 Clean the brew group by performing the 'Weekly brew group cleaning' cycle.
- 16 Install a new AquaClean filter in the water tank.

Tip: Using the AquaClean filter reduces the need for descaling!

What to do if the descaling procedure is interrupted

If the machine gets stuck during descaling, you can exit the descaling procedure by pressing the standby button. If this occurs, or in case of a power failure or accidental disconnection of the cord, do the following:

- 1 Empty and rinse the water tank thoroughly.
- 2 Fill the water tank with fresh water up to the CALC CLEAN level indication and switch the machine back on. The machine will heat up and perform an automatic rinsing cycle.
- 3 Before brewing any beverages, perform a manual rinsing cycle. To perform a manual rinsing cycle, first dispense half a water tank of hot water and then brew 2 cups of pre-ground coffee without adding ground coffee (see 'Brewing coffee with pre-ground coffee').

Note: If the descaling procedure was not completed, the machine will require another descaling procedure as soon as possible.

Warning icons and error codes

Meaning of the warning icons



Fill the water tank with fresh water to the MAX level indication.



The brew group is blocked by coffee powder. Clean the brew group.



The bean hopper is empty. Put new coffee beans in the bean hopper.



Insert the drip tray and close the service door.



The brew group is not in the machine or it is not inserted correctly. Insert the brew group.



If the display shows an error code, check section 'Meaning of the error codes' to see what the code on the display means and what you can do. The machine cannot be used when this icon is on the display.



The coffee grounds container is full. Make sure the machine is switched on. Then remove and empty the coffee grounds container.

Meaning of the error codes

Below you find a list of the error codes showing problems that you can solve yourself. Support videos are available on www.philips.com/coffee-support. If another error code appears, please contact the Philips Consumer Care Center in your country. For contact details, see the warranty leaflet.

Error code	Problem	Cause	Possible solution
01	The coffee grinder is blocked	The coffee exit duct is clogged.	Switch off the machine. Clean the coffee exit duct thoroughly with the handle of the measuring spoon or a spoon handle. Then switch the machine on again.
03 - 04	There is a problem with the brew group.	The brew group is dirty or not well greased.	Switch off the machine. Rinse the brew group with fresh water, let it air-dry and then lubricate it (see 'Lubrication'). Then switch the machine on again.

Error code	Problem	Cause	Possible solution
		The brew group is not positioned correctly.	Switch off the machine. Remove the brew group and reinsert it. Make sure the two reference signs on the side match before you slide the brew group back into the machine (see 'Reinserting the brew group'). Then switch the machine on again.
05	There is a water circuit problem.	There is air in the water circuit.	Switch off the machine. Make sure you insert the water tank into the machine properly. Check if the water tank compartment is clean and free from coffee beans. Then switch the machine on again.
			Restart the machine by switching it off and on again. Try to dispense 2-3 cups of hot water.
		The AquaClean filter was not prepared well before installation.	Switch off the machine and remove the filter from the water tank. Immerse the filter upside down in a jug with cold water and wait until no more air bubbles come out. Place back the filter in the water tank, restart the machine and dispense 2-3 cups of hot water.
14	The machine is overheated.	This can have several causes.	Switch the machine off and switch it back on again after 30 minutes.

Troubleshooting

This chapter summarizes the most common problems you could encounter with the machine. Support videos and a complete list of frequently asked questions are available on www.philips.com/coffee-care. If you are unable to solve the problem, contact the Consumer Care Center in your country. For contact details, see the warranty leaflet.

Problem	Cause	Solution
The machine does not switch on.	The machine is disconnected or the main switch is in the 'off' position (0).	Check if the mains cord is inserted correctly.
		Make sure the main switch is set to 'on' position (I).
The machine is in DEMO mode.	You pressed the standby button for more than 8 seconds.	Switch the machine off and then on again with the main switch on the back of the machine.

Problem	Cause	Solution
The drip tray fills up quickly.	This is normal. The machine uses water to rinse the internal circuit and brew group. Some water flows through the internal system directly into the drip tray.	Empty the drip tray when the 'drip tray full' indicator pops up through the drip tray cover. Place a cup under the dispensing spout to collect rinsing water.
The 'coffee grounds container full' icon remains displayed.	You emptied the coffee grounds container while the machine was switched off.	Always empty the coffee grounds container while the machine is switched on. If you empty the coffee grounds container when the machine is switched off, the coffee cycle counter is not reset.
	You placed back the coffee grounds container too fast.	Do not place back the coffee grounds container until the display message prompts you to put it back.
I cannot remove the brew group.	The brew group is not in the correct position.	Close the service door. Switch the machine off and back on again. Wait for the 'machine ready' screen to appear and then remove the brew group.
	You have not removed the coffee grounds container.	Remove the coffee grounds container before you remove the brew group.
I cannot insert the brew group.	The brew group is not in the correct position.	Reset the machine in the following way: place the drip tray and the coffee grounds container back. Leave the brew group out. Close the service door and switch the machine on and off. Then put the brew group in the correct position (see 'Reinserting the brew group') and reinsert it in the machine.
	The machine is still in the descaling procedure.	You cannot remove the brew group when the descaling procedure is in progress. First complete the descaling procedure and then remove the brew group.
The coffee is watery.	The grinder is set to a too coarse setting.	Adjust the grinder to a finer setting.
	The coffee exit duct is clogged.	Clean the coffee exit duct with the handle of the measuring spoon or a spoon handle. Then switch the appliance off and on again.
	The machine is performing its self-adjustment procedure.	Brew a few cups of coffee.
	The brew group is dirty or needs to be lubricated.	Clean and lubricate the brew group.
Coffee is leaking from the coffee dispensing spout.	The coffee dispensing spout is clogged.	Clean the coffee dispensing spout and its holes with a pipe cleaner.

Problem	Cause	Solution
	The coffee exit duct is clogged.	Clean the coffee exit duct with the handle of the measuring spoon or a spoon handle. Then switch the appliance off and on again.
The coffee is not hot enough.	The cups you use are cold.	Preheat the cups by rinsing them with hot water.
	The temperature is set too low. Check the menu settings.	Set the temperature to 'high' in the menu.
	You added milk.	Whether the milk you add is warm or cold, it always decreases the temperature of the coffee to some extent.
The machine does not grind the coffee beans.	The coffee exit duct is clogged.	Clean the coffee exit duct
The machine grinds the coffee beans, but coffee does not come out or coffee comes out slowly.	The coffee exit duct is blocked.	Clean the coffee exit duct with the handle of the measuring spoon or a spoon handle. Switch the appliance off and on again.
	The AquaClean filter was not prepared well for installation.	Switch off the machine and remove the filter from the water tank. Immerse the filter upside down in a jug with cold water and wait until no more air bubbles come out. Place back the filter in the water tank, restart the machine and dispense 2-3 cups of hot water.
	The grinder is set to a too fine setting.	Adjust the grinder to a coarser setting.
	The brew group is dirty.	Clean the brew group.
	The coffee dispensing spout is dirty.	Clean the coffee dispensing spout and its holes with a pipe cleaner.
	The machine circuit is blocked by limescale.	Descale the machine.
The milk does not froth.	The milk carafe is dirty or not inserted correctly.	Clean the carafe and make sure that you position and insert it correctly.
	The milk dispensing spout has not been opened fully.	Make sure that the milk dispensing spout is in the correct position.
	The milk carafe is incompletely assembled.	Make sure that all the components (especially the milk tube) have been assembled correctly

Problem	Cause	Solution
	The type of milk used is not suitable for frothing.	Different types of milk result in different amounts of froth and different froth qualities. We have tested the following milk types which proved to deliver a good milk froth result: semi-skimmed or full-fat cow's milk, soy milk and lactose-free milk.
There is water under the machine.	The drip tray is too full and has overflowed.	Empty the drip tray when the 'drip tray full' indicator pops up through the drip tray. Always empty the drip tray before you start descaling the machine.
	The machine is not placed on a horizontal surface.	Place the machine on a horizontal surface so that the 'drip tray full' indicator works properly.
I cannot activate the AquaClean filter and the machine asks for descaling.	You have already replaced the AquaClean filter 8 times.	Descalce your machine first and install the AquaClean filter. Always activate the AquaClean filter in the menu (see 'Activating the AquaClean filter'). Also do this when you replace the filter.
	The filter has not been replaced in time after the AquaClean filter icon flashed and the capacity dropped to 0%.	Descalce your machine first and then install the AquaClean filter.
	You did not install the AquaClean filter during first installation, but after having brewed approx. 50 coffees (based on 100ml cups). The machine has to be completely limescale-free before you install the AquaClean filter.	First descalce the machine and then install a new AquaClean filter. After descaling, the filter counter is reset to 0/8. Always confirm filter activation in the machine menu. Also do this after filter replacement.
	You did not activate the new or replaced AquaClean filter in the machine menu.	Descalce your machine first. Then activate the AquaClean filter in the menu (see 'Activating the AquaClean filter'). Also do this when you replace the filter.
The AquaClean filter icon does not appear on the display after I replaced the filter.	You did not confirm activation in the machine menu.	Confirm the activation of the filter in the machine menu. (see 'Activating the AquaClean filter') If the display shows 'START CALC CLEAN', you first need to descalce the machine. Remove the AquaClean filter before descaling and reinsert it afterwards.

Problem	Cause	Solution
The AquaClean filter is installed, but the descaling message appears.	You have not activated the AquaClean filter in the machine menu.	First descale the machine and then install a new AquaClean filter. This will reset the filter counter to 0/8. Always confirm filter activation in the machine menu (see 'Activating the AquaClean filter'), also after filter replacement.
The new water filter does not fit.	You are trying to install another filter than the AquaClean filter.	Only the AquaClean filter fits into the machine.



www.philips.com/coffee-care



421946037671



>75% recycled paper