

Register your product and get support at
www.philips.com/welcome

FC6148, FC6146

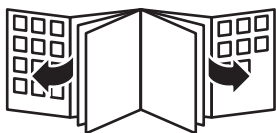

PHILIPS



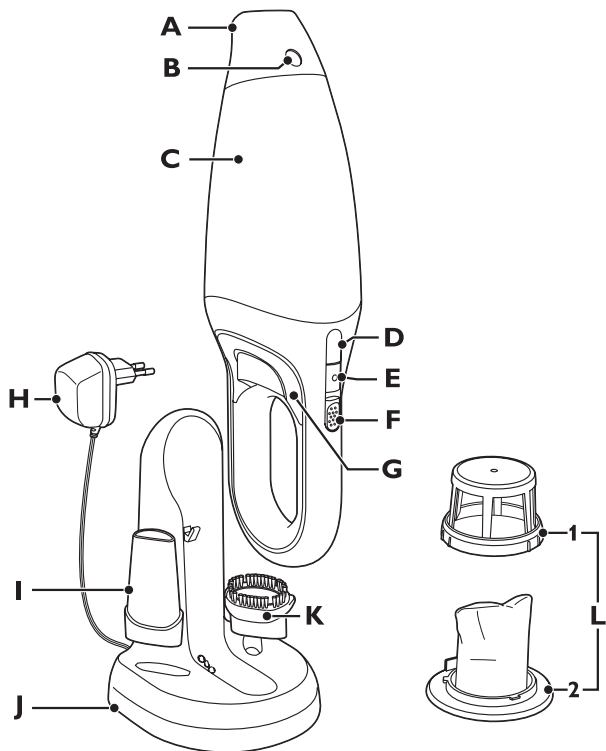

FC6148, FC6146

ENGLISH 6

简体中文 15

Introduction

Congratulations on your purchase and welcome to Philips! To fully benefit from the support that Philips offers, register your product at www.philips.com/welcome.

General description (Fig. 1)

- A** Detachable nozzle
- B** Nozzle release button
- C** Dust compartment
- D** Dust compartment release button
- E** Charging light
- F** On/off slide with 2 speeds
- G** Exhaust air openings
- H** Adapter
- I** Crevice tool
- J** Charger
- K** Brush tool
- L** Filter unit
 - 1 Outer filter
 - 2 Inner filter with filter holder

Important

Read this user manual carefully before you use the appliance and save it for future reference.

Danger

- Never suck up water or any other liquid. Never suck up flammable substances and do not suck up ashes until they are cold.
- Never immerse the vacuum cleaner or the charger in water or any other liquid.

Warning

- Check if the voltage indicated on the appliance corresponds to the local mains voltage before you connect the appliance.
- Do not use the vacuum cleaner or the charger if it is damaged.

- The charger and its adapter cannot be replaced. If the charger or its adapter is damaged, the appliance must be discarded.
- If the cord of the adapter is damaged, it cannot be replaced and the adapter must be discarded.
- The adapter contains a transformer. Do not cut off the adapter to replace it with another plug, as this causes a hazardous situation.
- This appliance is not intended for use by persons (including children) with reduced physical, sensory or mental capabilities, or lack of experience and knowledge, unless they have been given supervision or instruction concerning use of the appliance by a person responsible for their safety.
- Children should be supervised to ensure that they do not play with the appliance.

Caution

- Remove the adapter from the wall socket before you clean the charger.
- Only charge the vacuum cleaner with the charger supplied. During charging, the adapter feels warm to the touch. This is normal.
- Always switch off the vacuum cleaner after use.
- The voltage on the contact strips in the charger is low (max. 12 volts) and therefore not dangerous.
- Never block the exhaust air openings during vacuuming.
- Switch off the appliance when you recharge it.
- Always use the vacuum cleaner with the filter unit assembled.
- To avoid the risk of electric shock, be careful when you drill holes in the wall to attach the charger, especially close to a wall socket.
- Charge, store and use the appliance at a temperature between 5°C and 35°C.
- Do not dismantle or short-circuit the batteries. Protect the batteries from fire, heat and direct sunlight.

Electromagnetic fields (EMF)

This Philips appliance complies with all standards regarding electromagnetic fields (EMF). If handled properly and according to the instructions in this user manual, the appliance is safe to use based on scientific evidence available today.

Preparing for use

Installing the charger

- 1** Attach the charger to the wall as shown in the figure. (Fig. 2)
If you attach the charger to the wall, the space between the screw holes has to be 12cm.
- 2** You can also place the charger on a horizontal surface (e.g. a table or desk) (Fig. 3).
- 3** Wind excess mains cord around the reel in the back of the charger and pass the cord through the slot (Fig. 4).

Charging the appliance

Charge the appliance for at least 16 hours before you use it for the first time.

Tip: If you are not going to use the appliance for a longer period of time, remove the adapter from the wall socket to save energy.

- 1** Make sure the appliance is switched off.
- 2** Put the adapter in the wall socket.
- 3** Place the vacuum cleaner on the charger (Fig. 5).
 - Make sure you place the opening in the back of the vacuum cleaner on the hook of the charger (Fig. 6).
 - ▶ The charging light flashes to indicate that the appliance is charging (Fig. 7).
 - ▶ The charging light is on continuously to indicate that the appliance is fully charged.

Using the appliance

- 1** Push the on/off slide forwards to switch on the appliance (Fig. 8).
 - If you want to use normal power, select speed 1.
 - If you want to use high power, select speed 2.
- 2** Push the on/off slide backwards to switch off the appliance (Fig. 9).

Accessories

The appliance comes with the following accessories:

- a brush tool to clean delicate surfaces;
- a crevice tool to vacuum corners or narrow gaps.

- 1** Take the accessory you want to use from the charger.
- 2** Attach the accessory to the nozzle of the appliance (Fig. 10).

Cleaning

Never immerse the vacuum cleaner or the charger in water or any other liquid.

Always remove the adapter from the wall socket before you clean the charger.

- 1** Clean the outside of the appliance and the charger with a damp cloth.
- 2** If the contact points of the charger are dirty, wipe them with a dry cloth.

Emptying and cleaning the dust compartment

Make sure you empty and clean the dust compartment regularly.

Quick cleaning

To empty the dust compartment quickly:

- 1** Press the nozzle release button (1) and take the detachable nozzle off the appliance (2) (Fig. 11).
- 2** Shake the contents of the dust compartment out into a dustbin (Fig. 12).

Thorough cleaning

- 1** Hold the appliance over a dustbin, press the dust compartment release button (1) and remove the dust compartment (2) (Fig. 13).
- 2** Remove the filter unit from the dust compartment (Fig. 14).

10 ENGLISH

- 3 Empty the dust compartment by shaking it with your free hand (Fig. 15).
- 4 If necessary, clean the dust compartment with a damp cloth.
- 5 If necessary, clean the filter unit. See section 'Cleaning the filter unit'.
- 6 To reattach the dust compartment, align the slot on the dust compartment with the projection on the appliance. First attach the bottom of the dust compartment (1). Then push the top of the dust compartment towards the appliance (2) until it locks into place ('click') (Fig. 16).

Cleaning the filter unit

Make sure you clean the filter unit regularly.

- 1 Turn the outer filter anticlockwise (1) and remove it from the filter holder (2) (Fig. 17).

Leave the inner filter attached to the filter holder.

- 2 Clean the inner filter and the outer filter with a brush or with a normal vacuum cleaner if they are very dirty.

Note: If necessary, you can clean the inner filter and the outer filter in cold or lukewarm water. Dry the inner and outer filter thoroughly before you use the filter unit again.

- 3 Place the outer filter back onto the filter holder (1) and turn it clockwise to attach it (2). (Fig. 18)
- 4 Put the filter unit back into the dust compartment (Fig. 19).

Note: Make sure you insert the filter unit in the correct way.

Storage

- 1 You can store the vacuum cleaner and the accessories on the charger (Fig. 20).

Replacement

We advise you to replace the inner filter after a prolonged period of use or if you can no longer clean it properly.

Replacing the inner filter

- 1** Remove the filter unit from the dust compartment (Fig. 14).
- 2** Turn the outer filter anticlockwise (1) and remove it from the filter holder (2) (Fig. 17).
- 3** Gently turn the inner filter anticlockwise (1) and remove it from the filter holder (2) (Fig. 21).
- 4** Place a new inner filter on the filter holder (1) and turn it clockwise to attach it (2) (Fig. 22).
- 5** Push the tip of the inner filter inwards (Fig. 23).
- 6** Place the outer filter on the filter holder (1) and turn it clockwise to attach it (2). (Fig. 18)
- 7** Put the filter unit back into the dust compartment (Fig. 19).

Note: Make sure you insert the filter unit in the correct way.

Accessories

New inner filters are available under type no. FC8035. Contact your Philips dealer.

Environment

- Do not throw away the appliance with the normal household waste at the end of its life, but hand it in at an official collection point for recycling. By doing this, you help to preserve the environment (Fig. 24).
- The built-in rechargeable batteries contain substances that may pollute the environment. Remove the batteries when you discard the appliance. Do not throw away the batteries with the normal household waste, but hand them in at an official collection point. You

12 ENGLISH

can also take the appliance to a Philips service centre. The staff of this centre will remove the batteries for you and will dispose of them in an environmentally safe way (Fig. 25).

Removing the rechargeable batteries

Only remove the rechargeable batteries if they are completely empty.

Never let the rechargeable batteries come into contact with metal.

Remove the rechargeable batteries in the following way.

1 Let the vacuum cleaner run until it stops.

Try to switch on the appliance again to check if the batteries are really empty. If the motor starts, repeat the procedure.

2 Loosen and remove the screws. Open the vacuum cleaner (Fig. 26).

3 Put the motor unit with the batteries still attached in a large bowl with 3 litres of water and 3 teaspoons of salt.

- Make sure the whole motor unit is immersed. Add more water and salt according to the above proportion (1 teaspoon salt to 1 litre of water) if needed.
- Leave the motor unit and the batteries in the bowl for 24 hours.

4 Cut the connecting wires one by one and remove the batteries (Fig. 27).

Guarantee & service

If you need service or information or if you have a problem, please visit the Philips website at www.philips.com or contact the Philips Consumer Care Centre in your country (you find its phone number in the worldwide guarantee leaflet). If there is no Consumer Care Centre in your country, go to your local Philips dealer.

Troubleshooting

This chapter summarises the most common problems you could encounter with the appliance. If you are unable to solve the problem with the information below, contact the Consumer Care Centre in your country.

Problem	Solution
The appliance does not work.	The batteries may be low. Recharge the batteries.
	You may not have placed the appliance on the charger properly. Place the appliance on the charger properly. The charging light goes on to indicate that the appliance is charging.
	You may not have put the adapter properly in the wall socket. Put the adapter properly in the wall socket.
	The contact points on the appliance and/or on the charger may be dirty. Wipe them clean with a dry cloth.
	The appliance may have been switched on while it was on the charger. Make sure the appliance is switched off when you charge it.
The charging light does not go on.	If the appliance still does not work, take the appliance to your dealer or a service centre authorised by Philips for examination.
	Make sure that the adapter is inserted properly in the wall socket and that the appliance is switched off.
The vacuum cleaner does not vacuum properly.	The dust compartment may not be attached properly to the appliance. Attach the dust compartment properly to the appliance.

Problem	Solution
	The dust compartment may be full. Empty the dust compartment.
	The filter unit may be clogged. Clean the inner filter and the outer filter (see chapter 'Cleaning').
Dust escapes from the vacuum cleaner.	The dust compartment may be full. Empty the dust compartment.
	The dust compartment may not be attached properly to the appliance. Attach the dust compartment properly to the appliance.
	Perhaps the filter unit is not placed properly in the dust compartment. Place the filter unit properly in the dust compartment.
The vacuum cleaner does not work properly when one of the accessories is attached to the nozzle.	The dust compartment may be full. Empty the dust compartment.
	The accessory may be clogged. Remove the obstruction from the accessory.
	The filter unit may be clogged. Clean the inner filter and the outer filter (see chapter 'Cleaning').

产品简介

感谢您的惠顾，欢迎光临飞利浦！为了您能充分享受飞利浦提供的支持服务，请登陆以下网站注册您的产品，www.philips.com/welcome。

一般说明 (图 1)

- A** 可拆卸式吸嘴
- B** 吸嘴拆卸按钮
- C** 集尘桶
- D** 集尘桶拆卸按钮
- E** 充电指示灯
- F** 2 档速度开/关滑钮
- G** 排气口
- H** 适配器
- I** 缝隙吸嘴
- J** 充电器
- K** 毛刷
- L** 过滤器部件
 - 1 外层过滤器
 - 2 带过滤器架的内层过滤器

注意事项

使用产品之前，请仔细阅读本使用说明书，并妥善保管以备日后参考。

危险

- 切勿吸入水或其它液体。切勿吸入易燃物质，也不要吸入未冷却的灰烬。
- 切勿将真空吸尘器或充电器浸入水中或任何其它液体中。

警告

- 在将产品连接电源之前，请先检查产品所标电压与当地的供电电压是否相符。
- 如果真空吸尘器或充电器已损坏，请不要使用。

16 简体中文

- 充电器及其适配器无法更换。如果产品的充电器或适配器已损坏，则必须弃置产品。
- 如果适配器的电源线损坏，则不能更换，应弃置该适配器。
- 电源适配器内含有一个变压器。切勿将其剪断，而用另一个插头代替，否则将导致严重后果。
- 本产品不打算由肢体不健全、感觉或精神上有障碍或缺乏相关经验和知识的人（包括儿童）使用，除非有负责他们安全的人对他们使用本产品进行监督或指导。
- 应照看好儿童，确保他们不玩耍本产品。

注意

- 清洁充电器之前，务必将适配器从墙上的电源插座中拔出。
- 只能用本产品随附的充电器为吸尘器充电。充电期间，适配器会有微热，这是正常现象。
- 使用后，务必切断吸尘器的电源。
- 充电器接触片上的电压为低电压（最高 12 伏），因此是安全的。
- 吸尘时切勿阻塞排气口。
- 充电时请关闭产品电源。
- 使用吸尘器时总是装上过滤器。
- 为避免触电危险，在墙上钻孔安装充电器时应特别小心，尤其是在靠近墙上电源插座时。
- 产品充电、存放和使用的温度范围在 5° C 到 35° C 之间。
- 不要拆卸电池或致使其短路。防止电池接触火源、热源或直接曝晒于阳光下。

电磁场 (EMF)

这款飞利浦产品符合关于电磁场 (EMF) 的相关标准。据目前的科学证明，如果正确使用并按照本用户手册中的说明进行操作，本产品是安全的。

使用准备

安装充电器

- 1 如图所示将充电器安装在墙上。（图 2）
如果将充电器安装在墙上，两上螺丝孔之间的距离应为 12 厘米。

2 也可以将充电器放置在水平表面（如桌面或写字台上）。(图 3)

3 将多余的电源线缠绕在充电器背面的卷轴上，电源线从插槽中通过。(图 4)

为产品充电

在第一次使用前，要给本产品充至少 16 个小时的电。

提示：如果在较长一段时间内不使用本产品，请将适配器从插座上拔下，以节约能源。

1 确保产品电源已关闭。

2 将电源适配器插入电源插座。

3 将吸尘器放置在充电器上。(图 5)

- 确保将吸尘器背面的出口置于充电器的挂钩上。(图 6)

● 充电指示灯闪烁，表示吸尘器正在充电。(图 7)

● 充电指示灯持续亮起，表示吸尘器已充满电。

使用本产品

1 向前推动开/关按钮以接通产品电源。(图 8)

- 如果要使用正常吸力，请选择速度 1。

- 如果要使用较高吸力，请选择速度 2。

2 向后推动开/关按钮以切断产品电源。(图 9)

附件

产品随附有以下配件：

- 一个用于清洁柔软表面的毛刷；

- 一个用于角落或狭窄缝隙吸尘的缝隙吸嘴。

1 从充电器上取下所需配件。

2 将配件安装在产品的吸嘴上。(图 10)

清洁

切勿将真空吸尘器或充电器浸入水中或任何其它液体中。

18 简体中文

清洁充电器之前，务必将适配器从墙上的电源插座中拔出。

- 1 可用湿布清洁产品和充电器外部。
- 2 如果充电器的触点很脏，可用干布擦拭。

倒空并清洁集尘桶

确保定期倒空并清洁集尘桶。

快速清洁

要快速倒空集尘桶：

- 1 按吸嘴拆卸按钮 (1)，从吸尘器 (2) 上取下可分离吸嘴。(图 11)
- 2 晃动集尘桶中的尘垢以将其倒入垃圾桶。(图 12)

彻底清洁

- 1 将吸尘器拿到垃圾箱上方，按下集尘桶拆卸按钮 (1)，然后卸下集尘桶 (2)。(图 13)
- 2 将过滤器从集尘桶中取出。(图 14)
- 3 用另一只手晃动集尘桶以将其倒空。(图 15)
- 4 如果必要，可用湿布清洁集尘桶。
- 5 必要时，应清洁过滤器部件。见“清洁过滤器”部分。
- 6 要重新安装集尘桶，可以将集尘桶的槽与吸尘器的突出部分对齐。首先连接集尘桶的底部 (1)，然后将集尘桶的顶部推向吸尘器 (2)，直到它锁定到位 (“咔哒”一声)。(图 16)

清洁过滤器

确保定期清洁过滤器。

- 1 逆时针旋转外层过滤器 (1)，将其从过滤器架上取下 (2)。(图 17)
让内层过滤器继续留在过滤器架上。
- 2 如果过滤器很脏，请用毛刷或普通吸尘器清洁内层过滤器和外层过滤器。

注意：如果必要，还可以用冷水或温水清洁内层和外层过滤器。在您再次使用内层和外层过滤器之前，务必将其彻底擦干。

3 将外层过滤器放回过滤器架 (1)，然后顺时针旋转将其安装好 (2)。(图 18)

4 将过滤器重新装回集尘桶。(图 19)

注意：确保正确插入过滤器。

存放

1 您可以将吸尘器和配件存放在充电器上。(图 20)

更换

在长时间使用之后或者无法再清洗干净时，我们建议您更换内层过滤器。

更换内层滤芯

1 将过滤器从集尘桶中取出。(图 14)

2 逆时针旋转外层过滤器 (1)，将其从过滤器架上取下 (2)。(图 17)

3 逆时针轻轻旋转内层过滤器 (1)，将其从过滤器架上取下 (2)。(图 21)

4 将新的内层过滤器放在过滤器架上 (1)，然后顺时针旋转将其安装好 (2)。(图 22)

5 将内层过滤器的顶端向内推。(图 23)

6 将外层过滤器放到过滤器架上 (1)，然后顺时针旋转将其安装好 (2)。(图 18)

7 将过滤器重新装回集尘桶。(图 19)

注意：确保正确插入过滤器。

附件

可提供 FC8035 型号的全新内层滤芯。请与飞利浦经销商联系。

环境

- 弃置产品时，请不要将其与一般生活垃圾堆放在一起；应将其交给官方指定的回收中心。这样做有利于环保。(图 24)
- 内置可充电电池含有可污染环境的物质。在扔掉本产品前取出电池。请勿将电池与普通家庭垃圾一同丢弃，而应将其送到正式的回收点，也可以将产品交给飞利浦服务中心。维修中心的员工会帮您取出电池，并以环保的方式处理。(图 25)

卸下充电电池

只在充电电池的电量完全用尽时将其取出。

切勿让充电电池与金属物体接触。

按照以下方法取出充电电池。

1 让吸尘器运行到停止为止。

尝试再次打开产品电源，检查电池是否确实耗尽。如果马达仍可启动，请重复该过程。

2 拧松并卸下螺钉。打开真空吸尘器。(图 26)

3 将仍装有电池的马达放在盛有 3 升水和 3 茶匙盐的大碗中。

- 确保将整个马达部件完全浸入水中。如有必要，可按照上述比例添加水和盐（1 茶匙盐对 1 升水）。
- 将马达部件和电池留在碗中，保持 24 小时。

4 将电线一一剪断，然后取出电池。(图 27)

保修与服务

如果您需要服务或信息，或者有任何疑问，请访问飞利浦网站：www.philips.com。您也可与您所在地的飞利浦顾客服务中心联系（可从全球保修卡中找到其电话号码）。如果您的所在地没有飞利浦顾客服务中心，则可以当地的飞利浦经销商联系。

故障种类和处理方法

本章归纳了使用本产品时最可能遇到的问题。如果您无法根据下面的信息解决问题，请与贵国（地区）的飞利浦客户服务中心联系。

问题

解决方法

产品不能工作。

电池可能电量不足。请给电池充电。

您可能没有将吸尘器正确放置在充电器上。请将吸尘器正确安放在充电器上。充电指示灯亮起，表示吸尘器正在充电。

您可能没有将适配器正确插入电源插座。请将适配器正确插入电源插座。

吸尘器和/或充电器上的触点可能脏了。用干布将它们擦干净。

吸尘器在放到充电器上时，电源可能已打开。充电前要先关闭吸尘器电源。

如果产品仍无法正常工作，请将产品送往当地的飞利浦经销商，或经飞利浦授权的顾客服务中心，请他们检查。

充电指示灯不亮。

确保将适配器正确电源插座并且关闭了吸尘器的电源。

吸尘器不能正常吸尘。

集尘桶可能没有正确安装到产品上。将集尘桶正确安装到吸尘器上。

集尘桶可能已满。清空集尘桶。

过滤器可能阻塞。清洁内层过滤器和外层过滤器（请参阅“清洁”章节）。

尘土从吸尘器中溢出。

集尘桶可能已满。清空集尘桶。

问题

解决方法

集尘桶可能没有正确安装到产品上。将集尘桶正确安装到吸尘器上。

可能过滤器没有正确放置在集尘桶中。将过滤网正确安装到集尘桶中。

在将一个配件安装到吸嘴时，吸尘器不能正常工作。

集尘桶可能已满。清空集尘桶。

配件可能阻塞。从配件中取出阻塞物。

过滤器可能阻塞。清洁内层过滤器和外层过滤器（请参阅“清洁”章节）。

PHILIPS

产品 : 飞利浦充电式吸尘器
型号 : FC6148
额定电压 : 220V~
额定频率 : 50Hz
额定输入电流: 0.2A
生产日期 : 请见产品底部
产地 : 中国



飞利浦（中国）投资有限公司
上海市天目西路218号1602-1605

全国顾客服务热线：4008 800 008

本产品根据国标GB4706.1-2005，GB4706.7-2004，GB4343.1-2003及GB17625.1-2003制造

请妥善保管本使用说明书

发行日期：2009/07/01

<div style="display: flex; justify-content: space-between; align-items: center;"> <div style="text-align: center;">  <p>启益国际实业有限公司 SUNSTRONG INTERNATIONAL INDUSTRIAL LIMITED 香港荃湾柴角街83-93号荣兴工业大厦10字楼5-9号室 Tel:2411 6062 (8lines) Fax:2416 7568 广东省东莞市塘厦镇四村启益工业园 Tel:0769-87813330 87813331 Fax:0769-87727254 Email: mable_ho@sil.com.hk</p> </div> <div style="text-align: center;">  </div> </div>						
 <p>此标识为基于2006/02/28公布的[电子信息污染控制管理办法]及[标识要求],适用于在中国所售电子信息产品的环保期限之标识,不仅限于要求遵守与此产品相关的安全与使用上的注意事项,在由制造日起算的该期限内要求无因产品中的有害物质的发生外泄或突变,而对环境造成严重污染或对人体人身、财产造成严重之损害,且,此所限要求基于电子信息产品的环保使用期限(即寿命)的技术寿命法,而导出之年限。</p>						
<div style="border: 1px solid black; padding: 5px; display: inline-block;"> <有附属的消耗品时,以下为记数例> </div>						
注)一同包装的【例:灯、电池】(消耗品)的环保使用期限为【例:5年】。产品使用结束需要废弃时,务必配合遵从电子信息产品的法律法规与回收●循环利用相关的各省市的法律规定。						
SSA-5W-12 CH 150033F 产品中有毒有害物质或元素的名称及含量						
部件名称 Part Name	有毒有害物质或元素 Toxic or hazardous substances and Element					
	铅 Lead(Pb)	汞 Mercury(Hg)	镉 Cadmium(Cd)	六价铬 Hexavalent Chromium (Cr6+)	多溴联苯 Polybrominat d biphenyls(PBB)	多溴联苯醚 Polybrominated diphenyl ethers (PBDE)
铭牌Nameplate	○	○	○	○	○	○
无铅锡丝Lead-free	○	○	○	○	○	○
矽钢片SHEET	○	○	○	○	○	○
绝缘胶纸Polyester Maylar Tape	○	○	○	○	○	○
漆包线UEW	○	○	○	○	○	○
PVC	○	○	○	○	○	○
PE袋PRINTING BAG	○	○	○	○	○	○
裸铜线COPPER WIRE	○	○	○	○	○	○
三极管audion	○	○	○	○	○	○
电容capacitance	○	○	○	○	○	○
二极管diode	x	○	○	○	○	○
PCB	○	○	○	○	○	○
PC	○	○	○	○	○	○
扎线PE MINI TIE(BLACK)	○	○	○	○	○	○
AC PIN	x	○	○	○	○	○
稳压二极管DIP DIODE	x	○	○	○	○	○
电解电容ALUMINUM ELECTROLYTIC CAPACTORS	○	○	○	○	○	○
磁芯CORE	○	○	○	○	○	○
贴片电容MULTI-LAYER-CERAMIC CAPACITOR	x	○	○	○	○	○
贴片电阻CHIP RESISTOR	x	○	○	○	○	○
绕线电阻WIRE WOUND RESISTOR	○	○	○	○	○	○
电线electrical wire	○	○	○	○	○	○
○ : 表示该有毒有害物质在该部件有均质材料中的含量均在SJ/T11363-2006标准规定的限量要求以下: x : 表示该有毒有害物质至少在该部件的某一均质材料中的含量超出SJ/T11363-2006标准规定的限量要求.在ROHS豁免范围内.						

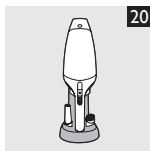
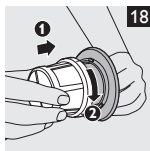
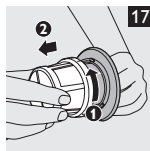
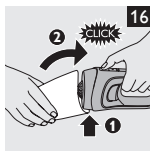
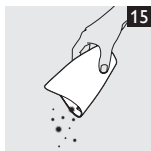
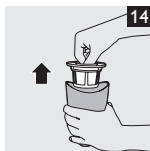
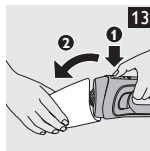
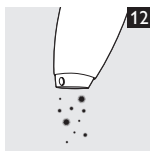
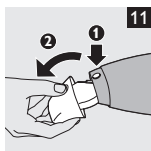
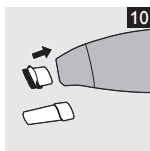
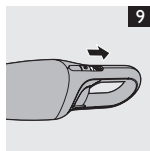
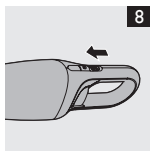
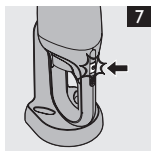
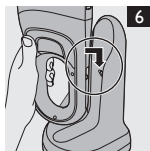
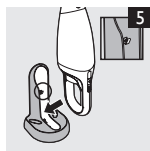
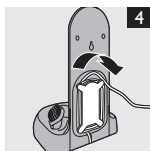
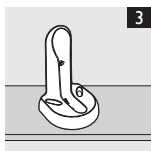
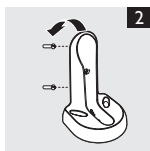

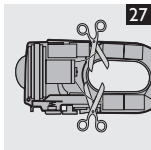
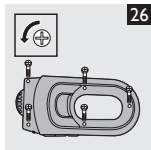
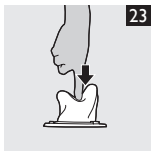
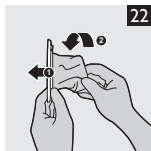



www.philips.com

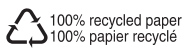

4222.003.3382.2