

HD8652

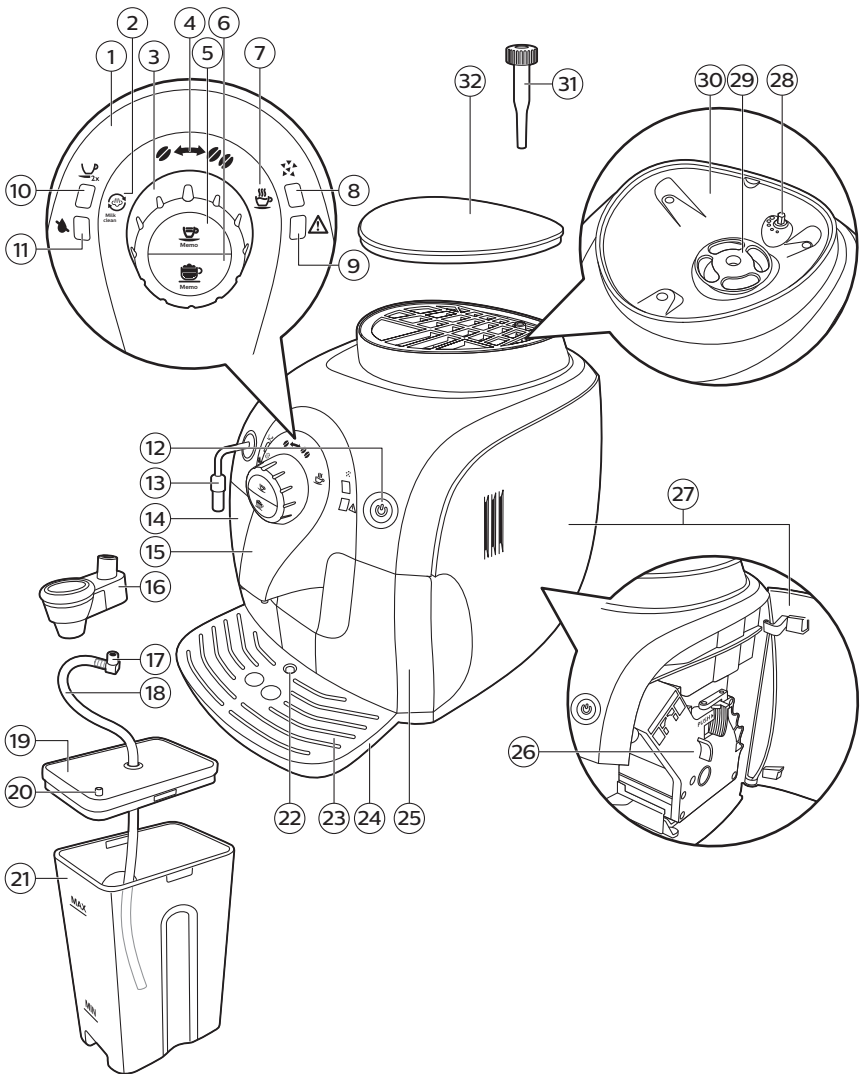

**PHILIPS**





# Contents

Introduction	4
Important	5
Warning	5
Caution	6
Electromagnetic fields (EMF)	7
Machine overview (Fig. 1)	7
First installation	8
Installing the machine	8
Filling the water tank	8
Filling the coffee bean container	9
Heating up the machine	9
Installing the Intenza+ water filter	10
Using the machine	11
Brewing 1 or 2 cups of espresso	11
Brewing milk- based beverages	12
Brewing cappuccino	12
Frothing milk	13
Hot water	13
Adjusting the machine	14
Adjusting the grinding degree	14
Adjusting the coffee volume with the MEMO function	15
Adjusting the cappuccino volume with the MEMO function	15
Cleaning and maintenance	15
Quick clean of the milk system	16
Cleaning the automatic milk frother (daily)	16
Full milk carafe cleaning with milk circuit cleaner (monthly)	16
Cleaning the brew group	19
Lubrication	21
Descaling the machine	22
Descaling procedure	22
Preparation	22
Descaling cycle	23
Rinsing cycle	23
Interruption of the descaling process	24
Meaning of light signals	25
Troubleshooting	27
Recycling	30
Guarantee and support	30
Ordering maintenance products	30
Technical specifications	31

## Introduction

Dear customer, we thank you for buying this Philips 2100 series automatic espresso machine! To fully benefit from the support that Philips offers, please register your product at [www.philips.com/welcome](http://www.philips.com/welcome). The machine is

suitable for preparing espresso coffee using whole coffee beans. It can also dispense steam and hot water. In this user manual you find all the information you need to install, use, maintain and get the best out of your machine.

For more product information and instruction videos, have a look on our website [www.philips.com/support](http://www.philips.com/support).

## Important

This machine is equipped with safety features. Nevertheless, read and follow the safety instructions carefully and only use the machine as described in these instructions, to avoid accidental injury or damage due to improper use of the machine. Keep this user manual for future reference.

## Warning

- Connect the machine to a wall socket with a voltage matching the technical specifications of the machine.
- Connect the machine to an earthed wall socket.
- Do not let the power cord hang over the edge of a table or counter, or touch hot surfaces.
- Never immerse the machine, mains plug or power cord in water (danger of electrical shock).
- Do not pour liquids on the power cord connector.
- Never direct the hot water jet towards body parts: danger of burns.
- Do not touch hot surfaces. Use handles and knobs.
- Remove the mains plug from the wall socket to switch off the machine.
  - If a malfunction occurs.
  - If the machine will not be used for a long time.
  - Before cleaning the machine.
- Pull on the plug, not on the power cord.
- Do not touch the mains plug with wet hands.
- Do not use the machine if the mains plug, the power cord or the machine itself is damaged.
- Do not make any modifications to the machine or its power cord.
- Only have repairs carried out by a service center authorized by Philips to avoid a hazard.

## 6 English

- The machine should not be used by children younger than 8 years old.
- This machine can be used by children aged from 8 years and above and by persons with reduced physical, sensory or mental capabilities or lack of experience and knowledge if they have been given supervision or instruction concerning use of the machine in a safe way and if they understand the hazards involved.
- Cleaning and user maintenance shall not be made by children unless they are older than 8 and supervised.
- Keep the machine and its cord out of the reach of children aged less than 8 years.
- Children should be supervised to ensure that they do not play with the machine.
- Never insert fingers or other objects in the coffee grinder.

### **Caution**

- This machine is intended for normal household use only. It is not intended for use in environments such as staff kitchens of shops, offices, farms or other work environments.
- Always put the machine on a flat and stable surface. Keep it in upright position, also during transport.
- Do not place the machine on a hotplate or directly next to a hot oven, heater or similar source of heat.
- Only put roasted coffee beans in the bean hopper. If ground coffee, instant coffee, raw coffee beans or any other substance is put in the coffee bean hopper, it may cause damage to the machine.
- Let the machine cool down before inserting or removing any parts. The heating surfaces may retain residual heat after use.
- Never fill the water tank with warm, hot or sparkling water, as this may cause damage to the water tank and the machine.
- Never use souring pads, abrasive cleaning agents or aggressive liquids such as petrol or acetone to clean the machine. Simply use a soft cloth dampened with water.

- Descale your machine regularly. The machine indicates when descaling is needed. Not doing this will make your appliance stop working properly. In this case repair is not covered under your guarantee.
- Do not keep the machine at temperatures below 0°C. Water left in the heating system may freeze and cause damage.
- Do not leave water in the water tank when the machine is not used over a long period of time. The water can be contaminated. Use fresh water every time you use the machine.

## Electromagnetic fields (EMF)

This Philips appliance complies with all applicable standards and regulations regarding exposure to electromagnetic fields.

## Machine overview (Fig. 1)

- 1 Control panel
- 2 Steam/ milk clean icon
- 3 Control dial
- 4 Coffee bean icons
- 5 Espresso button (Memo function)
- 6 Cappuccino button (Memo function)
- 7 Hot water icon
- 8 Descaling light
- 9 Warning light
- 10 2-cups/memo light
- 11 Water tank empty light
- 12 On/off button with light
- 13 Hot water/steam wand with protective handle
- 14 Water tank
- 15 Coffee dispensing spout
- 16 Automatic milk frother
- 17 Milk tube connector
- 18 Suction tube
- 19 Top of the milk carafe
- 20 Pin on top of the milk carafe
- 21 Milk carafe
- 22 Drip tray full indicator
- 23 Drip tray cover
- 24 Drip tray
- 25 Coffee grounds container
- 26 Brew group
- 27 Service door
- 28 Grinder adjustment knob
- 29 Ceramic coffee grinder
- 30 Coffee bean container
- 31 Grinding degree adjustment tool
- 32 Lid of coffee bean container

# First installation

## Installing the machine

- 1 Remove all packaging material from the machine.
- 2 Place the machine on a table or worktop away from the tap, the sink and heat sources.

Note: Leave at least 15 cm of free space above, behind and on both sides of the machine.

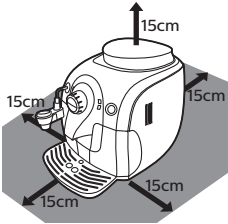

- 3 Insert the small plug into the socket located on the back of the machine.
- 4 Insert the plug into the wall socket.

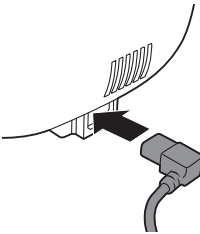

- 5 Remove the protective sticker from the drip tray and slide the drip tray into the guiding grooves in the front of the machine.

Note: Make sure the drip tray is fully inserted.

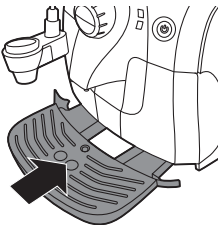

- 6 Insert the automatic milk frother.

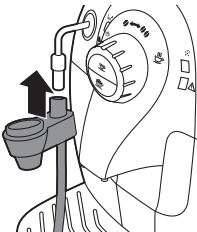

## Filling the water tank

- 1 Turn the automatic milk frother to the left.



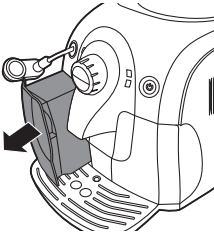

- 2 Remove the water tank from the machine.
- 3 Rinse the water tank under the tap.

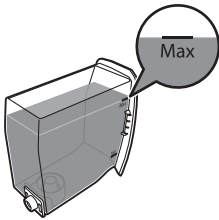

- 4 Fill the water tank with cold tap water up to the MAX indication.
- 5 Slide the water tank back into the machine.

## Filling the coffee bean container

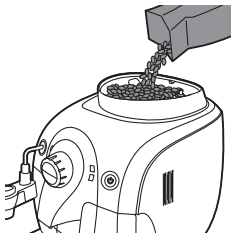

- 1 Fill the coffee bean container with espresso beans.

Note: Only use espresso beans. Never use ground coffee, unroasted coffee beans or caramelised coffee beans, as this may cause damage to the machine.

- 2 Put the lid on the coffee bean container.

## Heating up the machine

During the initial heat-up process, fresh water flows through the internal circuit to heat up the machine. This takes a few seconds.

- 1 Place a big cup under the hot water/steam wand and the coffee spout. Make sure the control dial points to one of the coffee bean icons.
- 2 Press the on/off button.

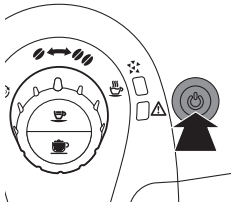

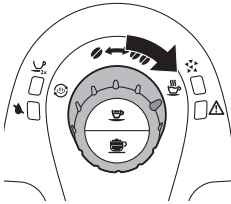

- 3** When the warning light flashes quickly, turn the control dial to the hot water icon and wait a few seconds.
- The warning light goes out and some water comes out of the hot water/steam wand or automatic milk frother.

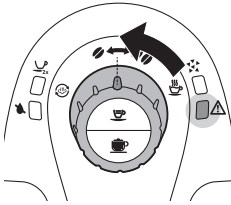

- 4** After a few seconds, when hot water stops coming out of the hot water/steam wand and the warning light flashes slowly, turn the control dial back to the single bean icon.
- The machine is heating up and the on/off button flashes slowly.
  - When the machine has heated up, it performs an automatic rinsing cycle to clean the internal circuit with fresh water. Water flows from the coffee spout.
  - When the on/off button lights up continuously, the machine is ready for the manual rinsing cycle.

Note: You can stop the automatic rinsing cycle by pressing the espresso or the cappuccino button.

Note: The automatic rinsing cycle also takes place 60 minutes after the appliance switches to standby mode or switches off.

## Installing the Intenza+ water filter

We advise you to install the Intenza+ water filter as this prevents scale build-up in your machine. You can buy the Intenza+ water filter separately. For more details, see chapter 'Guarantee and support', section 'Ordering maintenance products'.

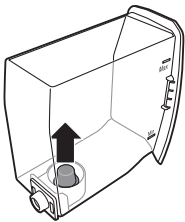

- 1** Remove the small white filter from the water tank and store it in a dry place.

Note: Please keep the small white filter for future use. You will need it for the descaling process.



- 2** Remove the filter from its packaging and immerse it in cold water with the opening pointing upwards. Press the sides of the filter gently to let out the air bubbles.

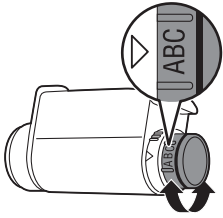

- 3 Turn the knob of the filter to the setting that corresponds to the water hardness of the area you live in.
  - a Very soft water/ soft water
  - b Hard water (default)
  - c Very hard water

Note: You can test the water hardness with a water hardness test strip.

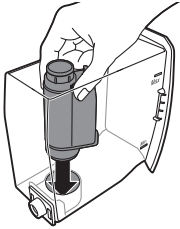

- 4 Place the filter in the empty water tank. Press it down until it cannot move any further.
- 5 Fill the water tank with fresh water up to the MAX indication and slide it into the machine.
- 6 Let the machine brew hot water until the water tank is empty (see chapter 'Using the machine', section 'Hot water').
- 7 Refill the water tank with fresh water up to the MAX indication and slide it back into the machine.
  - The on/off button lights up continuously.
 The machine is ready for use.

## Using the machine

To guarantee perfect espresso, the machine regularly rinses its inner circuit with water. This automatic rinsing cycle takes place 60 minutes after the appliance switches to standby mode or switches off. During the automatic rinsing cycle, some of the water flows through the inner circuit directly into the drip tray. Empty the drip tray regularly.

## Brewing 1 or 2 cups of espresso

- 1 Make sure the on/off button light lights up continuously and the control dial points to the desired coffee strength bean icon.
- 2 Place 1 or 2 cups under the coffee spout.
- 3 Select the coffee strength by turning the dial to one or two beans. Select 2 beans for a stronger taste.
- 4 Press the espresso button.

Note: You can interrupt the brewing cycle at any time. Press the same button that you pressed to start brewing coffee.

- Press the espresso button once to brew 1 cup of coffee.
- Press the espresso button twice to brew 2 cups of coffee.
- When brewing 2 cups of coffee the 2-cup light lights up. The machine grinds the required amount of coffee beans for one cup and then fills both cups half. Then the machine grinds coffee beans for one cup again and fills both cups fully.

Note: When the machine is left in standby mode, it switches off automatically after 60 minutes.

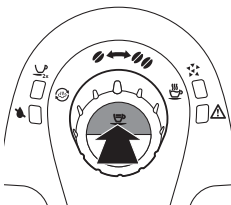

## Brewing milk- based beverages

Note: Use cold milk (at a temperature of approximately 5°C/41°F) with a protein content of at least 3% to ensure an optimal frothing result. You can use whole milk, semi-skimmed milk, soy milk and lactose free milk.

### Brewing cappuccino

**Warning: Danger of burning! Dispensing may be preceded by small jets of hot water. When steam is used, the hot water/steam wand and automatic milk frother could be hot. Only grab the steam wand by its protective handle.**

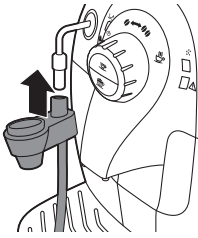

- 1 Attach the automatic milk frother to the hot water/steam wand.

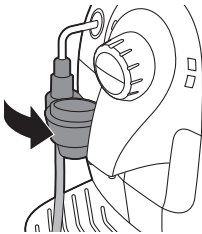

- 2 Turn the hot water/steam wand with the automatic milk frother towards the machine until the automatic milk frother touches the machine and is in horizontal position.

- 3 Remove the lid of the milk carafe and pour the milk in the milk carafe. Close the lid of the milk carafe.

- 4 Insert the other end of the suction tube into the milk carafe till the bottom of the milk carafe.

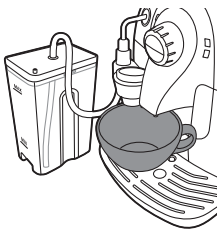

- 5 Place a large cup under the automatic milk frother and the coffee spout.

- 6 Select the coffee strength by turning the dial to one or two beans. Select 2 beans for a stronger taste.

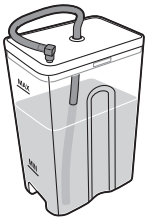
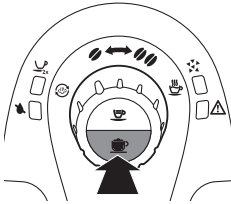

- 7 Press the cappuccino button. The machine dispenses first the milk and then coffee.
  - It will take a few seconds before the machine stops dispensing.

Note: If you want to interrupt the brewing cycle press the cappuccino button again.

- 8 The amount of coffee and milk can be customized, see chapter 'Adjusting the machine', section 'Adjusting coffee and milk length'.
- 9 Place a cup under the automatic milk frother. Perform a quick clean dispensing hot water for 3-5 seconds after brewing a cappuccino, see chapter 'Cleaning and maintenance', section 'Quick Clean of the milk system'.
- 10 Remove the milk tube connector from the automatic milk frother.
- 11 Plug the milk connector to the pin on the milk container lid and put the milk container in the fridge.

Note: After dispensing a milk based beverage perform a quick clean of the milk system by dispensing hot water for 5 seconds.

## Frothing milk

**Warning: Danger of burning! Dispensing may be preceded by small jets of hot water. When steam is used, the hot water/steam wand and automatic milk frother could be hot. Only grab the steam wand by its protective handle.**

- 1 Follow steps 1 to 5 from 'Brewing cappuccino' and turn the dial to the steam/milk clean icon to froth milk.
- 2 Turn the control dial to one or two coffee beans icon to stop frothing milk.

## Hot water

**Warning: Danger of scalding! Dispensing may be preceded by small jets of hot water. Use the appropriate protective handle only.**

- 1 Make sure the on/off button lights up continuously. If the on/off button flashes slowly, the machine is heating up.
- 2 Remove the automatic milk frother. Keep the protective handle on the hot water/steam wand.
- 3 Place a cup under the hot water/steam wand.

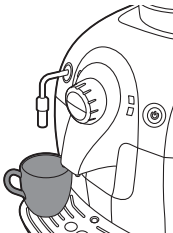

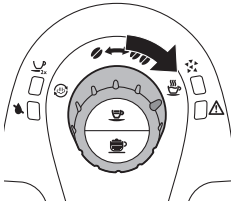

- 4 Turn the control dial to the hot water icon.
  - Water comes out of the hot water/steam wand.

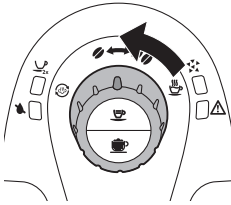

- 5 Turn the control dial back to one of the coffee bean icons when the cup contains the preferred amount of hot water.

## Adjusting the machine

You can adjust the grinding degree and coffee volume to obtain coffee that is perfectly customised to your taste.

### Adjusting the grinding degree

You can adjust the grinding degree of the machine. The ceramic coffee grinder guarantees accurate and perfect grinding and coarseness for every cup of coffee. It ensures full aroma preservation, delivering the perfect taste in every cup.

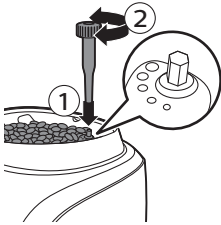

- Press the grinding degree adjustment knob firmly and then turn it one notch at a time.
- There are 5 different grinding degree settings you can choose from. The smaller the dot, the stronger the coffee.
- The difference becomes noticeable after you have brewed 2-3 cups of coffee at the new setting.

**Warning: Do not turn the grinding degree adjustment knob more than one notch at a time to prevent damage to the grinder.**

### Adjusting the coffee volume with the MEMO function

You can adjust the coffee volume to your taste and the size of your cups. The espresso button can be programmed.

- 1 Place one cup under the coffee dispensing spout.
- 2 Press and hold the espresso button. Release the button when the machine starts to grind coffee beans.
  - The 2-cups light and the on/off button flash slowly.
- 3 Press the espresso button when the cup contains the desired amount of coffee.

The machine automatically saves the new setting.

### Adjusting the cappuccino volume with the MEMO function

You can adjust the coffee volume to your taste and the size of your cups. The cappuccino button can be programmed.

- 1 Place a cup under the coffee dispensing spout.
- 2 Press and hold the cappuccino button. Release the button when the machine starts to grind coffee beans.
  - The 2-cup light and the on/off button flash slowly.
- 3 Press the cappuccino button again when the cup contains the desired amount of milk.

The machine automatically saves the new setting.

## Cleaning and maintenance

Regular cleaning and descaling prolongs the lifetime of your machine and ensures optimum quality and taste of your coffee.

**Warning: Never use scouring pads, abrasive cleaning agents or aggressive liquids to clean the machine.**

**Warning: Always unplug the machine and let it cool down before you clean it.**

Note: None of the detachable parts are dishwasher-proof. Rinse them under the tap.

## Quick clean of the milk system

**Note:** After brewing a cappuccino perform a quick clean of the milk system.

- 1 Place a cup under the automatic milk frother.
- 2 Turn the control dial to the hot water icon.
- 3 Dispense HOT WATER for 5 seconds
- 4 Turn the control dial to one of the coffee bean icons to stop hot water dispensing.

## Cleaning the automatic milk frother (daily)

- 1 Place a cup under the automatic milk frother.
- 2 Insert the suction tube into a cup filled with fresh water.
- 3 Turn the control dial to the steam/milk clean icon.
- 4 Dispense hot water for 5 seconds.
- 5 Turn the control dial to one of the coffee beans to stop hot water dispensing.

## Full milk carafe cleaning with milk circuit cleaner (monthly)

### Monthly cleaning of the automatic milk frother

Monthly cleaning of the automatic milk frother consists of two cleaning cycles carried out in sequence: the first cycle requires the use of Saeco milk circuit cleaner dissolved in water and the second cycle uses only water to rinse the circuit.

**Caution:** If the machine has been recently used, the steam tube and the automatic milk frother could be hot.

**Note:** Before you start the procedure, make sure that the water tank is filled up to the MAX level.

### Cleaning cycle with milk circuit cleaner and water.

- 1 Pour the content of a Saeco milk circuit cleaner sachet into the milk carafe and fill the milk carafe with water up to the MAX level. Close the lid of the milk carafe.
- 2 Insert the other end of the suction tube into the milk carafe till the bottom of the milk carafe.
- 3 Place a large container under the milk dispensing spout.
- 4 Turn the control dial to the steam/milk clean icon.
  - The machine dispenses the cleaning solution through the milk dispensing spout.
- 5 Let the machine dispense water until the water tank empty light lights up.
- 6 Detach the suction tube from the machine. Rinse the milk carafe thoroughly and fill it with fresh water up to the MAX level.
- 7 Repeat steps 3 to 6.

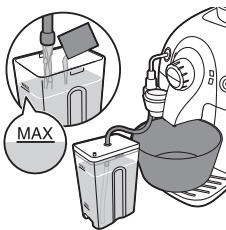

### Cleaning the parts of the automatic milk frother

The automatic milk frother comprises four parts that must be disassembled:



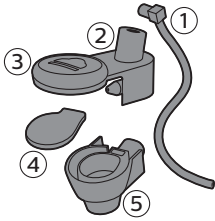

- 1 Suction tube
- 2 Milk frother lid
- 3 Rubber ring
- 4 Milk frother
- 5 Rubber cover

### How to clean the automatic milk frother

- 1 Remove the automatic milk frother from the steam tube.

**Caution: If the machine has been recently used, the steam tube and the automatic milk frother could be hot.**

- 2 Remove the suction tube from the milk frother lid.

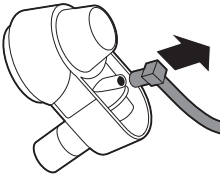

- 3 Remove the rubber ring from the automatic milk frother.



- 4 To detach the automatic milk frother, press the sides (1) and remove it by pulling it out while making slight lateral movements (2).

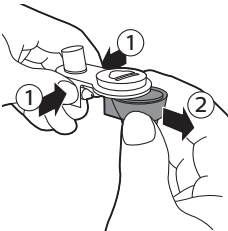

- 5 Remove the rubber lid from the milk frother.
- 6 Rinse the components with lukewarm water.

Note: You can also clean these components in the dishwasher.



18 English



**7** To reassemble, press in the middle to attach the rubber lid to the milk frother and make sure it is in place.

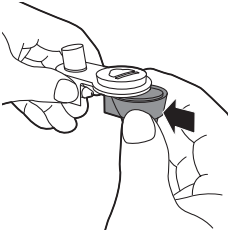

**8** Attach the automatic milk frother to the milk frother lid. When the two parts lock into place, you hear a click.

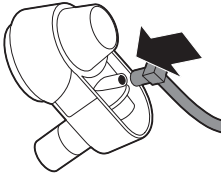

**9** Insert the suction tube into the automatic milk frother.

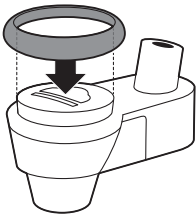

**10** Place the rubber ring back onto the automatic milk frother.

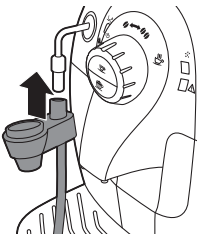

**11** Attach the automatic milk frother back to the hot water/steam wand.

## Cleaning the brew group

**Warning: Do not clean the brew group in the dishwasher and do not use washing-up liquid or a cleaning agent to clean it.**

Clean the brew group once a week.

- 1 Switch off the machine and unplug it.
- 2 Remove the coffee grounds container from the machine.

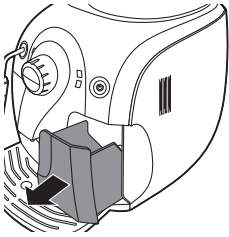

- 3 Open the service door.

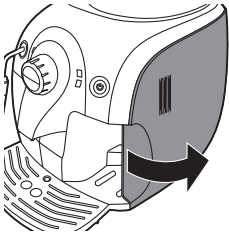

- 4 Press the PUSH button and pull at the grip of the brew group to remove it from the machine.

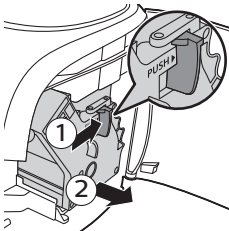

- 5 Clean the coffee exit duct thoroughly with a spoon handle or another round-tipped kitchen utensil.
- 6 Clean the inside of the machine with a damp cloth.

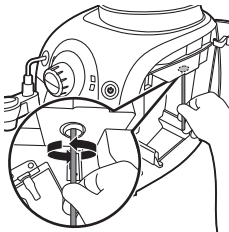

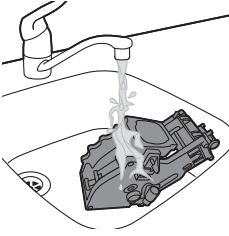

7 Rinse the outside of the brew group under a lukewarm tap.

**Warning: Never use any washing-up liquid or other cleaning agent to clean the brewing unit.**

**Warning: Do not dry the brew group with a cloth to prevent fibers from collecting inside the brewing unit. After rinsing, just shake excess water off the brewing unit or let it air-dry.**

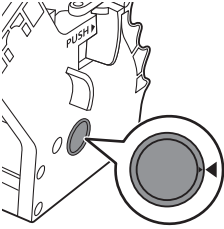

8 Before you slide the brew group back into the machine, make sure the two reference signs on the side match. If they do not match, perform the following step:

- Make sure the lever is in contact with the base of the brew group.

9 Make sure the locking hook of the brew group is in the correct position.

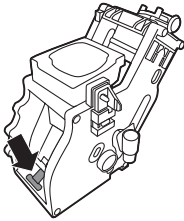

- To position the hook correctly, push it upwards until it is in uppermost position.

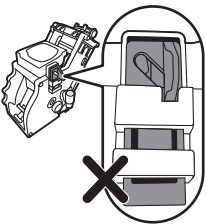
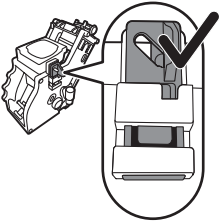

Note: The hook is not correctly positioned if it is still in bottommost position.

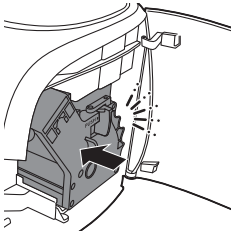

- 10** Slide the brew group back into the machine along the guiding rails on the sides until it clicks into position.

**Warning: Do not press the PUSH button.**

- 11** Close the service door.

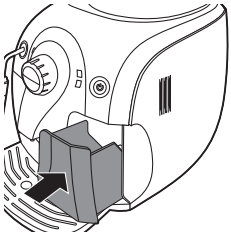

- 12** Slide the coffee grounds container back into the machine.

## Lubrication

For optimal performance of the machine you have to lubricate the brew group. See table below for the lubrication frequency. For support visit our website: [www.philips.com/support](http://www.philips.com/support).

Type of usage	Nr of daily products	Lubrication frequency
Low	1-5	Every 4 months
Normal	6-10	Every 2 months
Heavy	>10	Monthly

- 1 Switch off the machine and unplug it.
- 2 Remove the brew group and rinse it under a lukewarm tap as described in section 'Weekly cleaning of the brew group'.
- 3 Apply a thin layer of grease around the shaft in the bottom of the brew group.

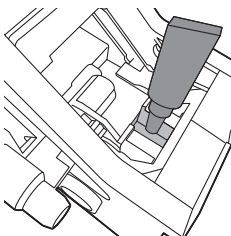

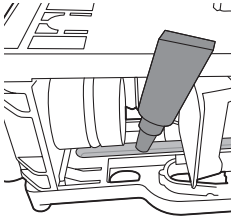

- 4 Apply a thin layer of grease to the rails on both sides (see figure).
- 5 Insert the brew group as described in section 'Weekly cleaning of the brew group'.

You can use the grease tube multiple times.

## Descaling the machine

Scale builds up inside the machine during use. It is essential to descale the machine when the orange descaling light lights up continuously. Only use the special Philips Saeco descaling solution to descale the machine. The Philips Saeco descaling solution is designed to ensure optimal performance of the machine. You can buy the Philips Saeco descaling solution in the online shop at [www.shop.philips.com/service](http://www.shop.philips.com/service).

Note: The use of other descaling products may cause damage to the machine and leave residues in the water.

**Warning: Never drink the water with descaling mixture that you pour into the water tank or any water with residues that comes out of the machine during the descaling procedure.**

Note: For more on-line support please visit our dedicated descaling page: [www.philips.com/descale](http://www.philips.com/descale).

## Descaling procedure

The descaling procedure lasts approximately 30 minutes and consists of a descaling cycle and a rinsing cycle.

### Preparation

- 1 Switch off the machine.

Warning: If you do not switch off the machine, you cannot enter the descaling

- 2 Empty the drip tray and place it back. Remove the automatic milk frother (if present).
- 3 Empty the water tank and remove the Intenza+ water filter (if present). Pour the entire bottle of the Philips/Saeco descaling solution into the water tank.
- 4 Add water to the descaling solution in the water tank up to the MAX indication.
- 5 Make sure the control dial is set to the coffee bean icon.
- 6 Place a bowl under the hot water/steam wand and coffee dispensing spout.

## Descaling cycle

- 1 Press the espresso button and cappuccino button simultaneously for approximately 5 seconds.
  - The orange descaling light flashes slowly during the entire descaling cycle.

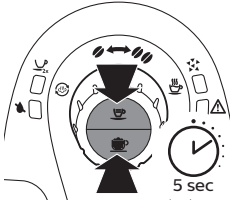

- 2 Turn the control dial to the hot water icon and brew hot water. Let hot water flow out of the hot water/steam wand for 10 seconds.
- 3 Turn the control dial back to the single bean icon. Wait approximately 1 minute to let the descaling solution act.
- 4 Press the espresso button to brew a cup of espresso. Wait approximately 1 minute to let the descaling solution act.

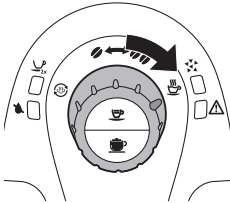

Note: During the descaling process, the coffee grinding function does not work. If you press the espresso button, only water will flow out of the machine.

- 5 Repeat steps 2 to 4 until the 'water tank empty' light lights up continuously.

## Rinsing cycle

- 1 Remove the water tank from the machine and rinse it.
- 2 Fill the water tank with fresh tap water up to the MAX indication and slide the water tank back into the machine.
- 3 Empty the big cup and place it back onto the drip tray under the hot water/steam wand.
- 4 Press the espresso button and brew a cup of espresso. Repeat this twice.

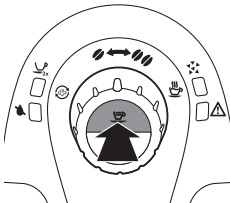

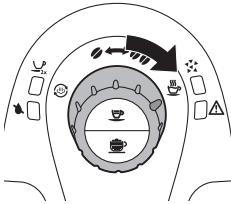

- 5 Turn the control dial to the hot water icon.
- 6 Let hot water flow out of the hot water/steam wand until the 'water tank empty' light lights up continuously.

Note: If you want to interrupt the water flow, turn the control dial back to the coffee bean icon. To restart the water flow, turn it back to the hot water icon.

- 7 Remove the drip tray, rinse it and place it back.
- 8 Reattach the automatic milk frother.
- 9 Remove the water tank and rinse it.
- 10 Reinstall the Intenza+ water filter (if present).
- 11 Fill the water tank with fresh tap water up to the MAX indication and slide the water tank back into the machine.
- 12 Press the on/off button to switch off the machine.  
When you switch the machine back on, it is ready for use again.

### Interruption of the descaling process

If the machine gets stuck in the descaling procedure, you can press the on/off button. This allows you to complete the descaling procedure. Follow the steps below to make sure your machine is ready to brew coffee again.

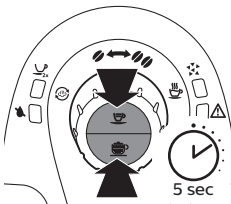

- 1 Press the espresso button and cappuccino button simultaneously for approximately 5 seconds.
- 2 Remove the drip tray, rinse it and place it back.
- 3 Remove the water tank and rinse it.
- 4 Fill the water tank with fresh tap water up to the MAX indication and slide the water tank back into the machine.
- 5 Press the espresso button and brew a cup of espresso. Repeat this twice.
- 6 Turn the control dial to the hot water icon. Let hot water flow out of the hot water/steam wand until the water tank empty light lights up continuously.
- 7 Remove the drip tray, rinse it and place it back.
- 8 Reattach the automatic milk frother.
- 9 Remove the water tank and rinse it.
- 10 Reinstall the Intenza+ water filter (if present).
- 11 Fill the water tank with fresh tap water up to the MAX indication and slide the water tank back into the machine.
- 12 Press the on/off button to switch off the machine.

When you switch the machine back on, it is ready for use again.

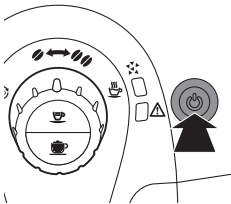



## Meaning of light signals

- The on/off button light lights up continuously. The machine is ready for use.

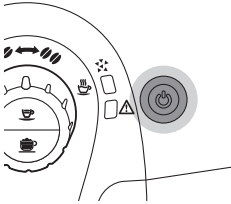

- The on/off button flashes slowly. The machine is warming up or performing a procedure.

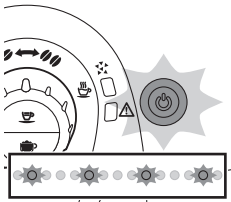

- The on/off button flashes quickly. The machine is overheated. Brew a cup of hot water to cool down the machine.

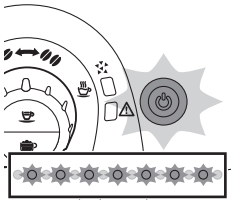

- The descaling and on/off button lights light up continuously. You have to descale the machine. Follow the instructions in chapter 'Descaling the machine'.

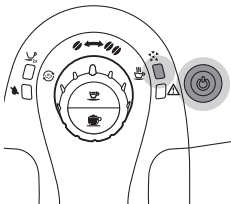

- The descaling light flashes slowly. The machine is in the descaling cycle.

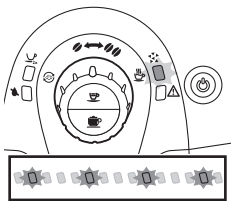

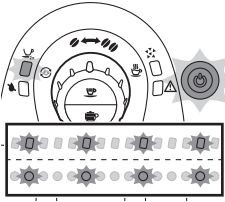

- The 2-cup and on/off button lights flash slowly. The machine is programming the amount of coffee to brew. Follow the instructions in chapter 'Using the machine', section 'Adjusting the coffee volume'.

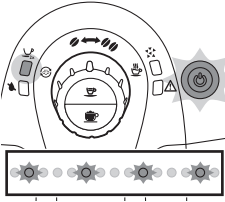

- The 2-cup light lights up continuously and the on/off button flashes slowly. The machine is brewing two cups of coffee.

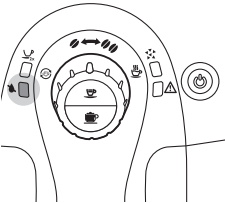

- The water tank empty light lights up continuously. The water level is low. Fill the water tank with fresh water up to the MAX level.

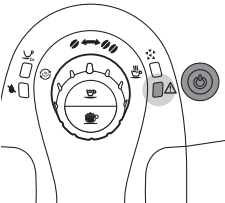

- The warning light lights up continuously and the on/off button light goes out. The coffee grounds container is full. Empty the coffee grounds container while the machine is on. Make sure that the warning light flashes before you reinsert the coffee grounds container.

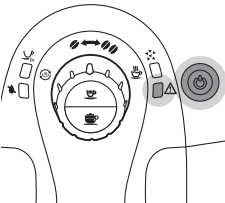

- The warning and on/off button lights light up continuously. The coffee bean container is empty. Refill the coffee bean container.

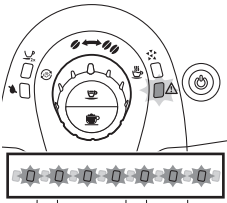

- The warning light flashes quickly. There is no water in the internal circuit. Turn the control dial to the hot water icon and let hot water come out of the machine until the water flows continuously. See chapter 'Preparing for use' section 'Heating up the machine'. Follow steps 3 and 4.

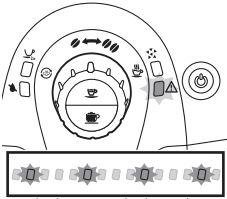

- The warning light flashes slowly. The brewing unit is not correctly inserted, the coffee grounds container is not inserted, the service door is open or the control dial is not in the correct position. Make sure the brewing unit and coffee grounds container are inserted correctly, the service door is closed and the control dial is in the correct position. If you cannot take out the brewing unit or place it back, switch the machine off and back on again.

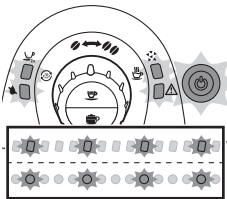

- All the lights flash slowly and simultaneously. The machine is out of order. Switch off the machine for 30 seconds, then switch it back on. Try this two or three times. If the machine does not reset, contact the Philips Consumer Care Centre.

## Troubleshooting

This chapter summarises the most common problems you could encounter with the machine. If you are unable to solve the problem with the information below, visit [www.philips.com/support](http://www.philips.com/support) for a list of frequently asked questions or contact the Philips Consumer Care Centre in your country.

Problem	Cause	Solution
There is water under the machine.	The drip tray is too full and overflowed.	Empty the drip tray when the drip tray full indicator pops up through the drip tray. Always empty the drip tray before you start descaling the machine.
	The machine is not placed on a horizontal surface.	Place the machine on a horizontal surface so that the drip tray full indicator works properly.
The machine does not switch on.	The machine is disconnected.	Make sure the small plug is inserted into the socket. Plug in and switch on the machine.

## 28 English

The machine is stuck in the descaling procedure.	The descaling process has been interrupted or proceeded in an incorrect order.	Press the on/off button. You can restart the descaling procedure or follow the instructions in chapter 'Descaling the machine', section 'Interruption of the descaling process'.
The coffee is not hot enough.	The cups you use are cold.	Preheat the cups by rinsing them with hot water.
	You added milk.	Whether the milk you add is warm or cold, it will always decrease the temperature of the coffee to some extent.
The coffee temperature decreases over time.	The machine has not been descaled in time.	Descalc the machine.
No hot water or steam comes out of the hot water/steam wand.	The hot water/steam wand is clogged.	Check if the hole of the hot water/steam wand is clogged. If so, clean the hole with a pin.
	The automatic milk frother may be dirty.	Clean the automatic milk frother.
The coffee has too little crema or is watery.	Replace the water filter (if present).	Remove the water filter and try again to dispense hot water. If this works replace the water filter.
	The grinder is set to a coarse setting.	Adjust the grinder to a finer setting.
	The coffee blend is not the correct one.	Try another coffee blend.
The brew group cannot be removed.	The machine is performing its self-adjustment.	Brew a few cups of coffee.
	The brew group is dirty.	Clean the brew group.
	The brew group is not positioned correctly.	Close the maintenance door. Switch the machine off and back on again. Wait for the machine ready screen to appear and then remove the brew group.
	The coffee grounds container is not removed.	Remove the coffee grounds container before removing the brew group.
	The machine is still in the descaling process.	You cannot remove the brew group when the descaling process is active. First complete the descaling process and then remove the brew group.

The brew group cannot be inserted.	The brew group is not in the correct position.	The brew group was not put in rest position before it was placed back. Make sure that the lever is in contact with the base of the brew group and that the hook of the brew group is in the correct position.
		Place the drip tray and the coffee grounds container back. Leave the brew group out. Close the maintenance door and switch the machine on and off. Then try to reinsert the brew group.
The machine grinds the coffee beans but no coffee comes out.	The grind is set too fine.	Adjust the grinder to a coarser setting.
	The brew group is dirty.	Clean the brew group.
	The coffee dispensing spout is dirty.	Clean the coffee dispensing spout and its holes with a pipe cleaner.
	The coffee exit duct is blocked.	Clean the coffee exit duct with the handle of the multifunctional tool or a spoon handle.
The coffee is too weak.	The grinder is set to a coarse setting.	Adjust the ceramic coffee grinder to a finer setting (see chapter 'Using the machine', section 'Adjusting the grinding degree').
	The machine is performing its selfadjustment.	Brew a few cups of coffee to let the machine adjust itself to the new grinding settings.
	The coffee blend is not the correct one.	Use a different type of coffee beans.
The drip tray is quickly filled.	This is normal. The machine uses water to rinse the internal circuit and brew group. Some water flows through the internal system directly into the drip tray.	Empty the drip tray when the 'drip tray full' full indicator pops up through the drip tray cover.
		Place a cup under the dispensing spout to collect rinsing water.
		The brew group or the drains behind or under the brew group may be blocked. Rinse the brew group with lukewarm water and clean the upper filter carefully. Also clean the inside of the machine with a soft, damp cloth.

There is not enough coffee in my cup.	There is no water in the internal circuit.	Air may be present in the internal circuit. Rinse the internal circuit of the machine by turning the control dial to the hot water icon and letting some hot water flow out of the machine.
	The cup volume has been changed.	Set with the memo function the cup volume.
	The brew group is dirty.	Clean the brew group (see chapter 'Cleaning and maintenance', section 'Cleaning the brew group').
The milk does not froth.	The automatic milk frother is dirty or not assembled or installed correctly.	Clean the automatic milk frother and make sure it is correctly assembled or installed.
	The type of milk used is not suitable for frothing.	Different types of milk result in different amounts of froth and different froth qualities. Semi-skimmed or full-fat cow's milk give good results.

## Recycling



- This symbol means that this product shall not be disposed of with normal household waste (2012/19/EU).
- Follow your country's rules for the separate collection of electrical and electronic products. Correct disposal helps prevent negative consequences for the environment and human health.

## Guarantee and support

If you need information or support, please visit [www.saeco.com/support](http://www.saeco.com/support) or read the separate guarantee leaflet.

If you need information or support, please contact the Philips Saeco hotline in your country. Contacts are included in the warranty booklet supplied separately or visit [www.saeco.com/support](http://www.saeco.com/support).

## Ordering maintenance products

- Intenza+ water filter (CA6702)
- Lubricant (HD5061)
- Descaling solution (CA6700)

## Technical specifications

<b>Feature</b>	<b>Value/ location</b>
Nominal voltage	Inside of service door
Power rating	Inside of service door
Size (w x h x d)	295mm x 325mm x 420mm
Weight	6.9 kg
Material	Plastic
Cord length	0.8m -1.2m
Water tank capacity	1000ml
Cup size	Up to 95mm
Coffee bean container capacity	170g
Coffee grounds container capacity	8 cakes
Pump pressure	15 bar
Boiler	Stainless steel
Safety devices	Thermal fuse

# 內容

簡介	33
重要事項	33
警示	33
警告	33
警告	34
警告	34
電磁波 (EMF)	34
咖啡機概觀 (圖 1)	34
首次安裝	35
安裝咖啡機	35
加水至水箱內	36
裝填咖啡豆槽	36
將咖啡機加熱	36
安裝 Intenza+ 濾網	37
使用咖啡機	38
沖煮 1 或 2 杯義式濃縮咖啡	38
沖煮奶類飲料	39
沖煮卡布奇諾咖啡	39
製作奶泡	40
熱水	40
調整咖啡機	41
調整研磨粗細	41
以 MEMO 功能調整咖啡量	41
以 MEMO 功能調整卡布奇諾咖啡量	41
清潔與維護	41
牛奶系統快速清潔	42
清潔自動奶泡機 (每天)	42
以牛奶管路清潔劑完整清潔牛奶罐 (每月)	42
清洗沖煮組件	45
潤滑	47
為咖啡機除垢	48
除垢程序	48
準備工作	48
除垢循環	48
沖洗循環	49
除垢程序中斷	49
指示燈號的意義	50
疑難排解	53
回收	55
保固與支援	55
訂購保養產品	55
技術規格	55



## 簡介

親愛的顧客，感謝您購買飛利浦 2100 系列自動義式濃縮咖啡機！為充分享受飛利浦為您提供的好處，請至下列位址註冊產品：[www.philips.com/welcome](http://www.philips.com/welcome)。這台咖啡機適合使用未研磨的完整咖啡豆來沖煮義式濃縮咖啡，也可以提供蒸氣與熱水。您可以在本使用手冊中找到所需的資訊，並以最佳方式安裝、使用、維護並善用咖啡機。

如需更多的產品資訊和影片教學，請造訪我們的網站：[www.philips.com/support](http://www.philips.com/support)。

## 重要事項

咖啡機備有多種安全功能，但是您仍需仔細閱讀並遵照安全性指示，僅可根據相關指示使用咖啡機，以避免不當使用咖啡機所造成的意外傷害或毀壞。請保留本使用手冊以供日後參考。

## 警示

### 警告

- 連接的牆上插座務必符合咖啡機技術規格的電壓。
- 將咖啡機連接到有接地的電源插座。
- 請勿讓電源線懸掛在餐桌或流理台邊緣，或是接觸高溫表面。
- 請勿將咖啡機、插頭或電源線浸入水中 (有觸電的危險)。
- 請勿讓液體淋濕電源線接頭。
- 請勿將熱水噴嘴朝向身體部位：有燙傷的危險。
- 請勿接觸高溫表面，務必使用握把和旋鈕。
- 從牆上插座拔下電源插頭來關閉咖啡機。
  - 如果發生故障。
  - 如果長時間不用咖啡機。
  - 清潔咖啡機之前。
- 請拔插頭，切勿拉扯電源線。
- 接觸插頭時，請確保雙手乾燥。
- 當插頭、電源線或機器本身受損時，請停止使用。
- 請勿擅自改裝咖啡機或電源線。
- 務必讓飛利浦授權的維修中心進行維修作業，以免發生危險。
- 八歲以下的兒童切勿使用咖啡機。
- 在有人從旁監督或適當指示如何安全使用咖啡機，以及瞭解潛在危險的狀況下，咖啡機可供 8 歲以上兒童、身體官能或心智能力退化者，或是經驗與使用知識缺乏者使用。
- 除非兒童年滿 8 歲以上且有人監督，否則請勿讓兒童進行清潔和使用者維護。
- 請將咖啡機和電源線放在 8 歲以下兒童無法取得之處。
- 請看管孩童，避免他們將咖啡機當成玩具。
- 請勿將手指或其他物品插入咖啡研磨機。

## 警告

### 警告

- 本咖啡機僅供一般家用，並非用於商店的員工廚房、辦公室、農舍或其他工作場所。
- 務必將產品置於穩固的平面上。搬運時也請保持直立狀態。
- 請勿將咖啡機放在加熱盤上，或直接放在高溫烤箱、加熱器或類似熱源旁邊。
- 豆槽只能放入烘焙的咖啡豆。如果豆槽放入研磨咖啡粉、即溶咖啡、未烘焙的咖啡豆或其他任何物質，可能會造成機器損壞。
- 安裝或拆除任何零件前，請務必先讓咖啡機冷卻。加熱面在使用後可能有餘熱。
- 請勿在水箱中裝入溫水、熱水或氣泡礦泉水，否則可能會損害水箱和咖啡機。
- 絕對不可使用鋼絲絨、磨蝕性的清潔劑或侵蝕性的液體 (例如汽油或丙酮) 清潔咖啡機。使用軟布沾水擦拭即可。
- 定期為咖啡機除垢。咖啡機會提示除垢的時間。如果未定期除垢，咖啡機可能會無法正常運作。保固並未涵蓋此情況的修復作業。
- 請勿將咖啡機放在低於 0° C 的地方。加熱系統內殘留的水可能會凍結並造成損壞。
- 若長時間不使用咖啡機，則請勿將水留在水箱內。水可能會有汙染，每次使用咖啡機時均請使用乾淨的水。

## 電磁波 (EMF)

本飛利浦產品符合所有電磁波暴露的相關適用標準和法規。

## 咖啡機概觀 (圖 1)

- 1 控制面板
- 2 蒸氣/牛奶清潔圖示
- 3 控制鈕
- 4 咖啡豆圖示
- 5 義式濃縮咖啡按鈕 (Memo 功能)
- 6 卡布奇諾咖啡按鈕 (Memo 功能)
- 7 熱水圖示
- 8 除垢指示燈
- 9 警示燈
- 10 2 杯/記憶指示燈
- 11 水箱已空指示燈
- 12 附指示燈的開關按鈕
- 13 附保護握把的熱水/蒸氣棒
- 14 水箱
- 15 咖啡流出口
- 16 自動奶泡機
- 17 牛奶管接頭
- 18 吸塵管
- 19 牛奶罐蓋
- 20 牛奶罐蓋插座
- 21 牛奶罐
- 22 滴盤已滿指示燈
- 23 滴盤蓋
- 24 滴盤
- 25 咖啡粉槽

- 26 沖煮組件
- 27 維修門蓋
- 28 研磨調整旋鈕
- 29 陶瓷咖啡研磨器
- 30 咖啡豆槽
- 31 研磨粗細調整工具
- 32 咖啡豆槽蓋

## 首次安裝

### 安裝咖啡機

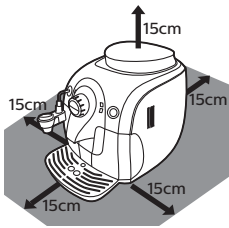

- 1 移除咖啡機的所有包裝材料。
- 2 將咖啡機放置於餐桌或流理台，遠離水龍頭、水槽與熱源。

注意：咖啡機的上方、背面及兩側必須至少保留 15 公分的間隔距離。

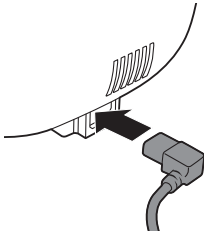

- 3 將小插頭插入咖啡機背面的插孔。
- 4 將插頭正確插入電源插座。

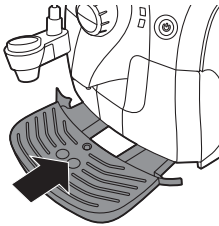

- 5 移除滴盤上的保護貼紙，並將滴盤推進咖啡機前方的導引溝槽中。

注意：請確認滴盤已完全插入。

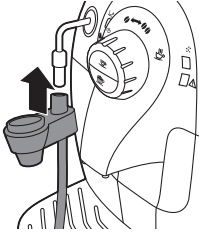

6 安裝自動奶泡機。

## 加水至水箱內

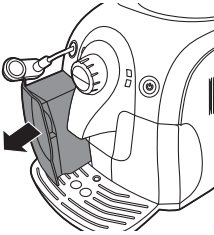

- 1 向左轉動自動奶泡機。
- 2 從咖啡機中取出水箱。
- 3 將水箱放在水龍頭下沖洗。

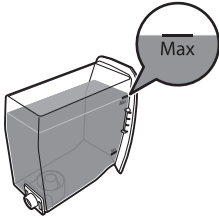

- 4 將冷的自來水注入水箱至 MAX 刻度。
- 5 將水箱推回咖啡機中。

## 裝填咖啡豆槽

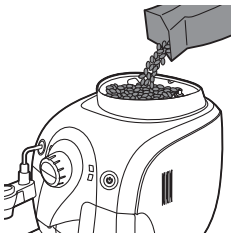

- 1 使用義式濃縮咖啡豆裝填咖啡豆槽。

注意：僅能使用義式濃縮咖啡豆。請勿使用研磨咖啡粉、未烘焙或焦糖化的咖啡豆，否則可能造成機器損壞。

- 2 將蓋子放在咖啡豆槽上。

## 將咖啡機加熱

在初期加熱程序期間，乾淨的水會流經內部管路將咖啡機加熱，這會持續數秒鐘。

- 1 在熱水/蒸氣棒和咖啡流出口下方放一個大杯子，確定控制鈕指向其中一種咖啡豆圖示。

- 2 按下開關按鈕。

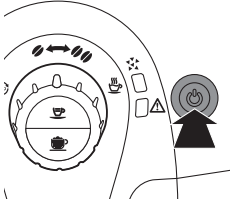

- 3 警示燈快速閃爍時，請將控制鈕轉到熱水圖示並稍候幾秒鐘。  
- 警示燈就會熄滅，並有一些水從熱水/蒸氣棒或自動奶泡機流出。

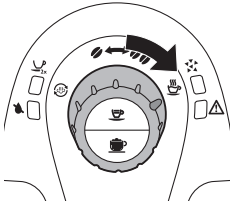

- 4 幾秒後，停止從熱水/蒸氣棒流出熱水時，警示燈就會緩慢閃爍，此時請將控制鈕轉回至單個咖啡豆圖示。  
- 咖啡機正在加熱，且開關按鈕會緩慢閃爍。  
- 咖啡機完成加熱之後，便會執行自動沖洗循環，用乾淨的水清洗內部管路。水會從咖啡流出口中流出。  
- 開關按鈕持續亮起時，咖啡機即可開始進行手動沖洗循環。

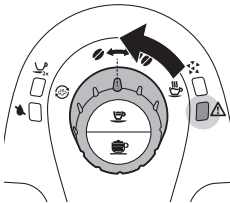

注意：您可以隨時按下義式濃縮咖啡或卡布奇諾咖啡按鈕來停止自動沖洗循環。

注意：切換為待機模式或關閉電源 60 分鐘後，咖啡機也會開始自動沖洗循環。

## 安裝 Intenza+ 濾網

建議安裝 Intenza+ 濾網，避免水垢在咖啡機中堆積。Intenza+ 濾網可另外購買。如需更多資訊，請參閱「保固與支援」單元「訂購保養產品」一節。

- 1 從水箱中取出小型白色濾網，並收納在乾燥的地方。

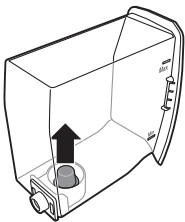

注意：請留著小型白色濾網以供日後使用。在進行除垢程序時會用到。



- 2 從包裝中取出濾網，並將開口朝上浸泡於冷水中。輕按濾網兩側，將氣泡洩出。

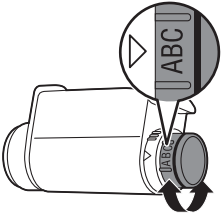

- 3 將濾網旋鈕旋轉至與您居住區域水質硬度相符的設定。
  - a 水質很軟/軟水
  - b 硬水 (預設)
  - c 水質硬度很高

注意：您可以使用水質硬度試紙測試水質硬度。

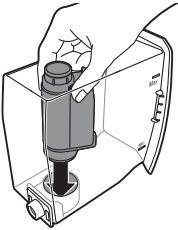

- 4 將濾網放入空的水箱中。將濾網往下壓，直到無法再移動為止。
- 5 在水箱中裝入乾淨的水到 MAX 刻度，然後將水箱裝回機器上。
- 6 讓咖啡機沖煮熱水，直到水箱沒水為止 (請參閱「使用咖啡機」單元「熱水」一節)。
- 7 在水箱中重新裝入乾淨的水到 MAX 刻度，然後將水箱裝回咖啡機上。
  - 開關按鈕持續亮起。

您現在可以開始使用咖啡機。

## 使用咖啡機

為確保沖煮出完美的義式濃縮咖啡，咖啡機會定期以水沖洗內部管路。切換為待機模式或關閉電源 60 分鐘後，咖啡機會開始此自動沖洗循環。在自動沖洗循環期間，部分的水會流經內部管路並直接流入滴盤內。請定期清空滴盤。

### 沖煮 1 或 2 杯義式濃縮咖啡

- 1 請確定開關按鈕指示燈持續亮起，且控制鈕指向所需咖啡濃度的咖啡豆圖示。
- 2 將一或兩個咖啡杯放在咖啡流出口下方。
- 3 選擇咖啡濃度時，可將控制鈕轉到一或兩個咖啡豆。選擇 2 個咖啡豆表示口味較濃。

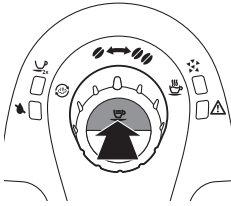

#### 4 按下義式濃縮咖啡按鈕。

注意：您隨時可中止沖煮循環，只要按下開始沖煮咖啡時按下的同一個按鈕即可。

- 按下義式濃縮咖啡按鈕一次可沖煮一杯咖啡。
- 按兩下義式濃縮按鈕即可沖煮兩杯咖啡。
- 沖煮 2 杯咖啡時，2 杯指示燈會亮起。咖啡機會研磨一杯咖啡所需的咖啡豆，然後沖煮出兩杯半滿的咖啡。接著，咖啡機會再研磨沖煮一杯的咖啡豆，並將兩杯填滿。

注意：當機器停留在待機模式時，60 分鐘後就會自動關閉電源。

## 沖煮奶類飲料

注意：使用蛋白質含量至少 3% 的冰牛奶 (溫度約 5° C/41° F)，確保製作出最佳奶泡。您可以使用全脂牛奶、半脫脂牛奶、豆漿和零乳糖牛奶。

### 沖煮卡布奇諾咖啡

**警告：小心燙傷！** 咖啡流出之前可能會先稍微噴出熱水。使用蒸氣時，熱水/蒸氣棒和自動奶泡機可能會很燙。拿取蒸氣棒時請務必使用保護握把。

1 將自動奶泡機裝至熱水/蒸氣棒。

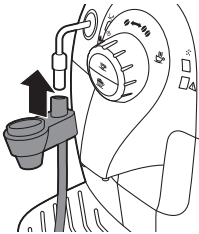

2 將熱水/蒸氣棒和自動奶泡機一起往咖啡機方向轉動，直到自動奶泡機接觸到咖啡機且為水平位置。

3 取下牛奶罐蓋，將牛奶倒入。蓋起牛奶罐蓋。

4 將吸塵管的另一頭放入牛奶罐的最底部。

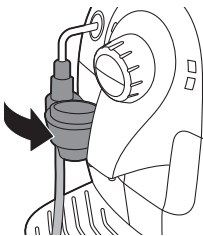

5 將一個大杯子放在自動奶泡機下方，靜候咖啡流出。

6 選擇咖啡濃度時，可將控制鈕轉到一或兩個咖啡豆。選擇 2 個咖啡豆表示口味較濃。

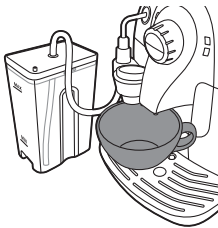

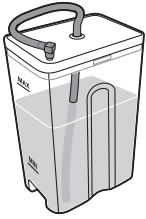
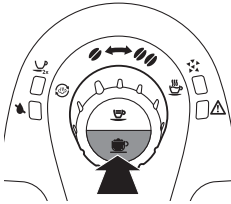

- 7 按壓卡布奇諾咖啡按鈕。咖啡機會先流出牛奶，然後才是咖啡。
  - 咖啡機流完咖啡需要幾秒鐘的時間。

注意：若要中止沖煮循環，請再按一次卡布奇諾咖啡按鈕。

- 8 咖啡量和牛奶量可自訂，請參閱「調整咖啡機」單元「調整咖啡和牛奶流量」一節。
- 9 將咖啡杯放在自動奶泡機下方。在沖煮卡布奇諾咖啡後，讓熱水流 3-5 秒進行快速清潔。請參閱「清潔與維護」單元「牛奶系統快速清潔」一節。
- 10 從自動奶泡機拆下牛奶管接頭。
- 11 將牛奶管接頭插入牛奶罐插座，接著將牛奶罐放入冰箱。

注意：在流出奶類飲料之後，讓熱水流 5 秒來進行牛奶系統的快速清潔。

### 製作奶泡

**警告：小心燙傷！** 咖啡流出之前可能會先稍微噴出熱水。使用蒸氣時，熱水/蒸氣棒和自動奶泡機可能會很燙。拿取蒸氣棒時請務必使用保護握把。

- 1 請依照「沖煮卡布奇諾咖啡」一節中的步驟 1 至 5，將控制鈕轉到蒸氣/牛奶清潔圖示來製作奶泡。
- 2 將控制鈕轉到一或兩個咖啡豆圖示，即可停止製作奶泡。

### 熱水

**警告：小心燙傷！** 咖啡流出之前可能會先稍微噴出熱水。務必使用適當的保護握把。

- 1 請確定開關按鈕持續亮起。如果開關按鈕緩慢閃爍，表示咖啡機正在加熱。
- 2 拆下自動奶泡機。保護握把需留在熱水/蒸氣棒上。
- 3 在熱水/蒸氣棒下方放一個咖啡杯。

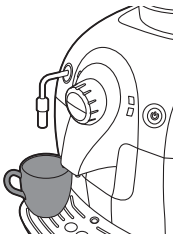

- 4 將控制鈕轉到熱水圖示。
  - 水會從熱水/蒸氣棒中流出。

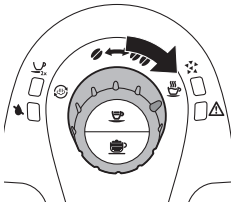



- 5 當杯子裝滿需要的熱水量時，將控制鈕轉回到其中一個咖啡豆圖示。

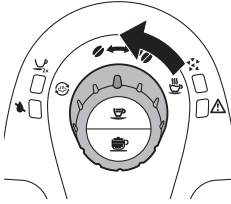

## 調整咖啡機

您可以調整研磨粗細與咖啡量，以獲得符合您口感的專屬完美咖啡。

### 調整研磨粗細

您可以調整咖啡機的研磨粗細。陶瓷咖啡研磨器可確保您沖煮的每杯咖啡都完美地經過均勻的研磨。如此可保留完整的咖啡香氣，為每杯咖啡帶來完美口感。

- 用力按下研磨粗細調整旋鈕，然後每次轉動一個溝槽。
- 您可以從 5 種不同的研磨粗細設定中進行選擇。點愈小，咖啡愈濃。
- 使用新設定時，沖煮 2-3 杯咖啡之後，差異會變得更明顯。

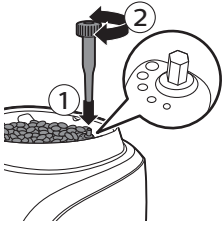

**警告：** 轉動研磨粗細調整旋鈕時，每次請勿超過一個溝槽，以免研磨機受損。

### 以 MEMO 功能調整咖啡量

咖啡量可以依照您的口味和咖啡杯大小進行調整。義式濃縮咖啡按鈕可供設定。

- 1 將一個咖啡杯放在咖啡流出口下方。
- 2 按住義式濃縮咖啡按鈕。當咖啡機開始研磨咖啡豆時，放開按鈕。
  - 2 杯指示燈和開關按鈕會緩慢閃爍。
- 3 當杯子裝滿需要的咖啡量時，按下義式濃縮咖啡按鈕。

咖啡機便會自動儲存新的設定。

### 以 MEMO 功能調整卡布奇諾咖啡量

咖啡量可以依照您的口味和咖啡杯大小進行調整。卡布奇諾咖啡按鈕可供設定。

- 1 將一個咖啡杯放在咖啡流出口下方。
- 2 按住卡布奇諾咖啡按鈕。當咖啡機開始研磨咖啡豆時，放開按鈕。
  - 2 杯指示燈和開關按鈕會緩慢閃爍。
- 3 當杯子裝滿需要的牛奶量時，再次按下卡布奇諾咖啡按鈕。

咖啡機便會自動儲存新的設定。

## 清潔與維護

定期清潔及去除水垢可延長咖啡機的壽命，並可確保最佳咖啡品質與口感。

**警告：** 請勿使用菜瓜布、磨蝕性清潔劑或強效清潔液清洗咖啡機。

**警告：** 在進行清潔之前，請務必先拔除咖啡機插頭並待其冷卻。

注意：所有可拆式零件皆不可用洗碗機清洗。請將其置於水龍頭下沖洗。

## 牛奶系統快速清潔

注意：沖煮一杯卡布奇諾咖啡後，請執行牛奶系統的快速清潔。

- 1 將咖啡杯放在自動奶泡機下方。
- 2 將控制鈕轉到熱水圖示。
- 3 讓熱水流出 5 秒鐘。
- 4 將控制鈕轉到其中一個咖啡豆圖示，即可讓熱水停止流出。

## 清潔自動奶泡機 (每天)

- 1 將咖啡杯放在自動奶泡機下方。
- 2 將吸塵管放入裝滿清水的杯子。
- 3 將控制鈕轉到蒸氣/牛奶清潔圖示。
- 4 讓熱水流出 5 秒鐘。
- 5 將控制鈕轉到其中一個咖啡豆，即可讓熱水停止流出。

## 以牛奶管路清潔劑完整清潔牛奶罐 (每月)

### 每月清潔自動奶泡機

自動奶泡機的每月清潔依序會進行兩個清潔循環：第一個循環需使用 Saeco 牛奶管路清潔劑加水，第二個循環只要使用清水清洗管路即可。

**注意事項：**如果機器不久前使用過，蒸氣棒和自動奶泡機可能會很燙。

注意：開始程序之前，請先確認水箱已到 MAX 刻度。

### 以牛奶管路清潔劑和水進行清潔循環。

- 1 將 Saeco 牛奶管路清潔包的內容物倒入牛奶罐，然後將水倒滿至 MAX 刻度。蓋起牛奶罐蓋。
- 2 將吸塵管的另一頭放入牛奶罐的最底部。
- 3 將一個大容器放在牛奶流出口下方。
- 4 將控制鈕轉到蒸氣/牛奶清潔圖示。
  - 咖啡機會經由牛奶流出口流出清潔溶液。
- 5 讓咖啡機將水流出，直到水箱已空指示燈亮起。
- 6 拆下咖啡機的吸塵管。徹底清洗牛奶罐，然後以清水裝滿至 MAX 刻度。
- 7 重複步驟 3 至 6。

### 清潔自動奶泡機零件

自動奶泡機有四個必須拆卸的零件：

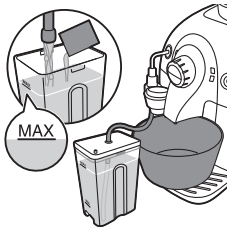

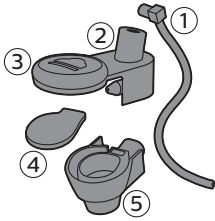

- 1 吸塵管
- 2 奶泡機上蓋
- 3 橡膠圈
- 4 奶泡機
- 5 橡膠蓋

### 如何清潔自動奶泡機

- 1 從蒸氣管拆除自動奶泡機。

**注意事項：** 如果機器不久前使用過，蒸氣棒和自動奶泡機可能會很燙。

- 2 從奶泡機上蓋拆除吸塵管。

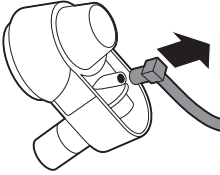

- 3 從自動奶泡機拆除橡膠圈。

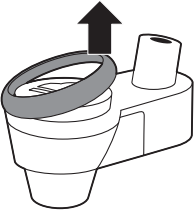

- 4 拆除自動奶泡機時，請按住側邊 (1) 稍微左右移動拉出 (2)。

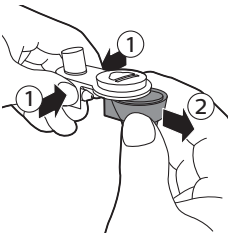

- 5 從奶泡機拆除橡膠蓋。
- 6 以溫水沖洗組件。

**注意：** 您可以在洗碗機中清潔這些組件。



## 44 繁體中文

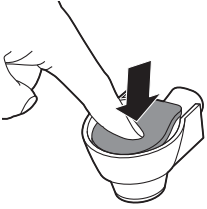

7 重新組裝時，將橡膠蓋的中間往奶泡機按下，並確認已經安裝到位。

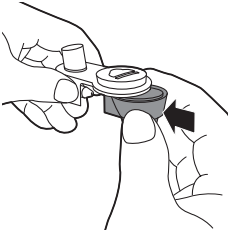

8 將自動奶泡機安裝至奶泡機上蓋。聽到喀噠聲，表示兩個零件安裝到位。

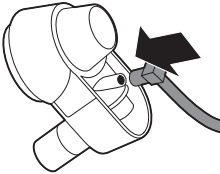

9 將吸塵管裝入自動奶泡機。

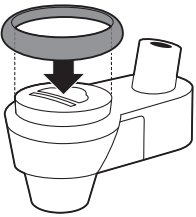

10 將橡膠圈裝回自動奶泡機。

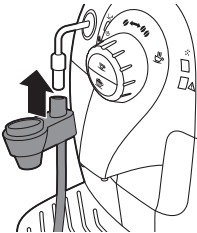

11 將自動奶泡機裝回熱水/蒸氣棒。

## 清洗沖煮組件

**警告：** 請勿將沖煮組件放入洗碗機清洗，同時也請勿使用洗碗精或清潔劑來清潔。

每週清潔沖煮組件一次。

- 1 關閉咖啡機電源，並拔除插頭。
- 2 從咖啡機中取出咖啡粉槽。

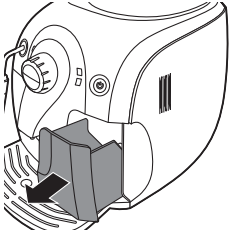

- 3 打開維修門蓋。

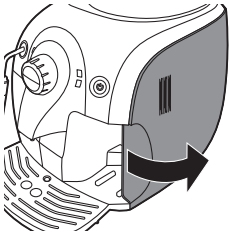

- 4 按下「PUSH」(推) 按鈕並拉動沖煮組件上的提把，將其從咖啡機取下。

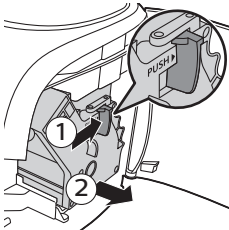

- 5 請用湯匙握把或其他圓端的廚房器具徹底清潔咖啡出口輸送管。
- 6 請以濕布清潔機器內部。

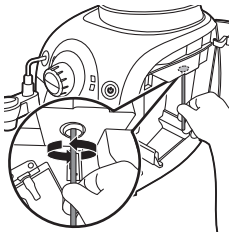

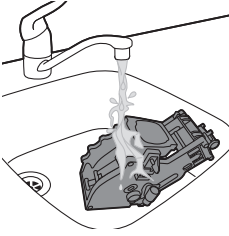

7 在水龍頭下以溫水沖洗沖煮組件外部。

**警告：** 請勿使用任何洗碗精或其他清潔劑來清潔沖煮裝置。

**警告：** 請勿用布擦乾沖煮組件，以避免沖煮裝置內累積纖維。沖洗後，只要甩乾沖煮裝置多餘的水份或自然風乾即可。

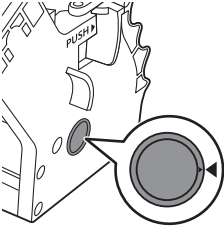

8 將沖煮組件推回咖啡機之前，請確定兩側的參考記號相符。如不相符，請執行下列步驟：

- 確定拉桿接觸到沖煮組件底部。

9 請確定沖煮組件的鎖定鉤位於正確的位置。

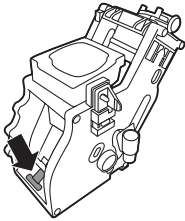

- 要將鉤正確定位，請將它往上推到最上方的位置。

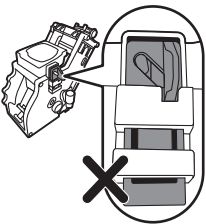
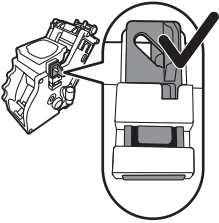

**注意：** 如果鉤還在最底部的位置，它就無法正確定位。

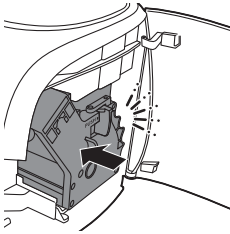

10 沿著兩側的導引軌道將沖煮組件推回咖啡機，直至卡入定位。

**警告：請勿按下「PUSH」(推) 按鈕。**

11 關閉維修門蓋。

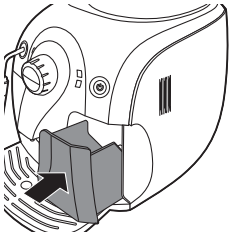

12 將咖啡粉槽推回咖啡機中。

## 潤滑

為發揮咖啡機的最大效能，請務必為沖煮組件進行潤滑。請參考下表的潤滑頻率。如需支援，請造訪我們的網站：[www.philips.com/support](http://www.philips.com/support)。

使用類型	每日產品用量	潤滑頻率
低度	1-5	每 4 個月
一般	6-10	每 2 個月
重度	>10	每月

- 1 關閉咖啡機電源，並拔除插頭。
- 2 拆卸沖煮組件，然後按照「每週清潔沖煮組件」一節中的指示，在水龍頭下以溫水徹底沖洗。
- 3 在沖煮組件底部的軸周圍塗抹一層薄薄的潤滑劑。

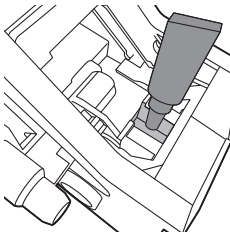

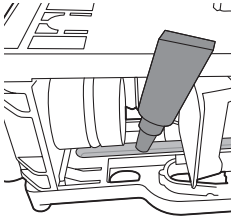

- 4 在軌道兩側塗抹一層薄薄的潤滑劑 (見圖示)。
- 5 按照「每週清潔沖煮組件」一節的指示裝入沖煮組件。

潤滑劑管可重複使用。

## 為咖啡機除垢

咖啡機使用時會積聚污垢。請務必在橘色除垢指示燈持續亮起時，為咖啡機進行除垢。只能使用特定的飛利浦 Saeco 除垢溶液為咖啡機除垢。飛利浦 Saeco 除垢溶液專為確保讓咖啡機發揮最佳效能而設計。您可以前往 [www.shop.philips.com/service](http://www.shop.philips.com/service)，在線上商店購買飛利浦 Saeco 除垢溶液。

注意：使用其他除垢產品可能會造成咖啡機受損，並在水中留下殘留物。

**警告：**請勿飲用您倒入水箱含除垢混合物的水，或在除垢程序期間從咖啡機所流出有殘留物的水。

注意：如需更多線上支援，請造訪我們的除垢專屬網頁：  
[www.philips.com/descale](http://www.philips.com/descale)。

## 除垢程序

除垢程序會持續 30 分鐘左右，其中包含除垢循環和沖洗循環。

### 準備工作

- 1 關閉咖啡機電源。

警告：如果您未關閉咖啡機電源，就無法進行除垢

- 2 清空滴盤後將其放回。拆下自動奶泡機 (如果有的話)。
- 3 清空水箱，並取下 Intenza+ 濾網 (如果有的話)。將整瓶飛利浦/Saeco 除垢溶液倒入水箱。
- 4 將水加入水箱中的除垢溶液至 MAX 刻度。
- 5 請確定控制鈕已設定至咖啡豆圖示。
- 6 在熱水/蒸氣棒和咖啡流出口下方放一個碗。

### 除垢循環

- 1 同時按下義式濃縮咖啡按鈕和卡布奇諾咖啡按鈕約 5 秒鐘。
  - 在整個除垢循環期間，橘色除垢指示燈會緩慢閃爍。

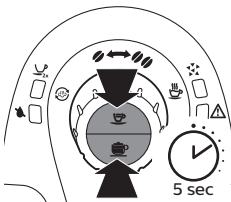



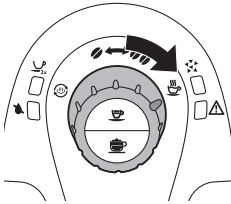

- 2 將控制鈕轉至熱水圖示並沖煮熱水。讓熱水從熱水/蒸氣棒流出 10 秒鐘。
- 3 將控制鈕轉回到單個咖啡豆圖示。等待約 1 分鐘，讓除垢溶液起作用。
- 4 按下義式濃縮咖啡按鈕，沖煮一杯義式濃縮咖啡。等待約 1 分鐘，讓除垢溶液起作用。

注意：在除垢程序期間，咖啡研磨功能無法運作。如果您按下義式濃縮咖啡按鈕，此時只有水會流出咖啡機。

- 5 重複步驟 2 至 4，直到「水箱已空」指示燈持續亮起為止。

### 沖洗循環

- 1 從咖啡機中取出水箱，再用水沖洗乾淨。
- 2 在水箱中裝入乾淨的自來水到 MAX 刻度，然後將水箱推回機器上。
- 3 請將大杯子清空後放回熱水/蒸氣棒下方的滴盤上。
- 4 按下義式濃縮咖啡按鈕，沖煮一杯義式濃縮咖啡。請重複此步驟兩次。

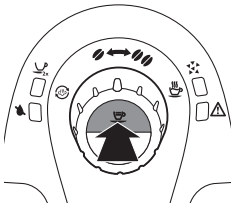

- 5 將控制鈕轉到熱水圖示。
- 6 讓熱水流出熱水/蒸氣棒，直到「水箱已空」指示燈持續亮起為止。

注意：如果您想中斷水流，請將控制鈕轉回至咖啡豆圖示。若要重新開始水流，請將其轉回到熱水圖示。

- 7 取出滴盤，並在沖洗後將其放回。
- 8 重新裝上自動奶泡機。
- 9 取出水箱，並沖洗乾淨。
- 10 重新安裝 Intenza+ 濾網 (如果有的話)。
- 11 在水箱中裝入乾淨的自來水到 MAX 刻度，然後將水箱推回機器上。
- 12 按下開關按鈕，關閉咖啡機電源。  
開啟咖啡機電源後，即可再次使用。

### 除垢程序中斷

如果在進行除垢程序時，咖啡機卡住不動，您可以按下開關按鈕，這樣就可以完成除垢程序。請依照下列步驟操作，確認您的咖啡機已可再次沖煮咖啡。

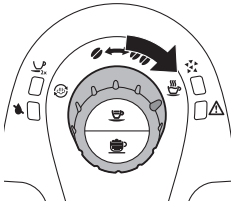

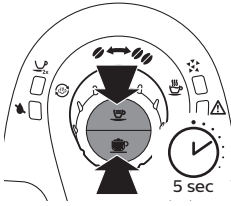

- 1 同時按下義式濃縮咖啡按鈕和卡布奇諾咖啡按鈕約 5 秒鐘。
- 2 取出滴盤，並在沖洗後將其放回。
- 3 取出水箱，並沖洗乾淨。
- 4 在水箱中裝入乾淨的自來水到 MAX 刻度，然後將水箱推回機器上。
- 5 按下義式濃縮咖啡按鈕，沖煮一杯義式濃縮咖啡。請重複此步驟兩次。
- 6 將控制鈕轉到熱水圖示。讓熱水流出現熱水/蒸氣棒，直到水箱已空指示燈持續亮起為止。
- 7 取出滴盤，並在沖洗後將其放回。
- 8 重新裝上自動奶泡機。
- 9 取出水箱，並沖洗乾淨。
- 10 重新安裝 Intenza+ 濾網 (如果有的話)。
- 11 在水箱中裝入乾淨的自來水到 MAX 刻度，然後將水箱推回機器上。
- 12 按下開關按鈕，關閉咖啡機電源。  
開啟咖啡機電源後，即可再次使用。

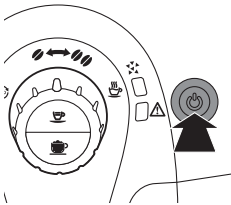

## 指示燈號的意義

- 開關按鈕指示燈持續亮起。您現在可以開始使用咖啡機。

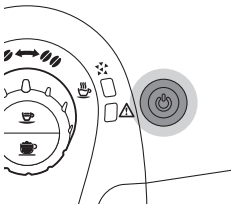

- 開關按鈕緩慢閃爍，代表咖啡機正在加熱或執行某個程序。

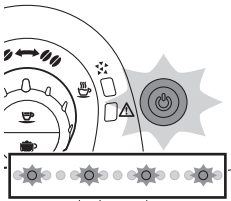

- 開關按鈕快速閃爍，代表咖啡機已過熱。請沖煮一杯熱水來冷卻咖啡機。

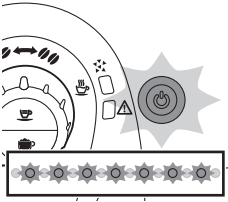

- 除垢指示燈和開關按鈕指示燈持續亮起，代表您必須為咖啡機除垢。請依照「為咖啡機除垢」單元的說明操作。

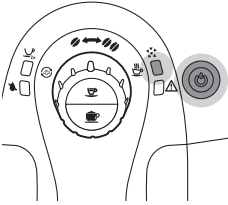

- 除垢指示燈緩慢閃爍，代表咖啡機正在進行除垢循環。

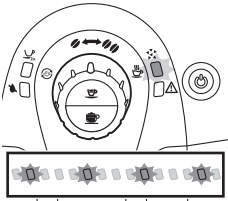

- 2 杯指示燈和開關按鈕指示燈緩慢閃爍，代表咖啡機正在設定要沖煮的咖啡量。請依照「使用咖啡機」單元「調整咖啡量」一節的說明操作。

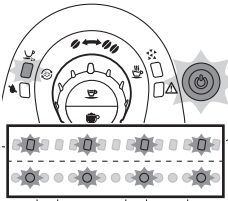

- 2 杯指示燈持續亮起，且開關按鈕緩慢閃爍，代表咖啡機正在沖煮兩杯咖啡。

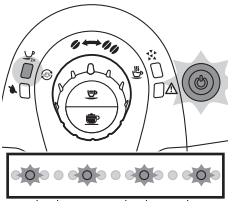

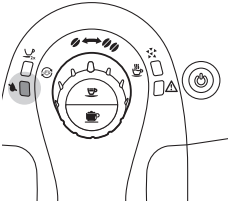

- 水箱已空指示燈持續亮起，代表水位過低。在水箱中裝入乾淨的水到 MAX 刻度。

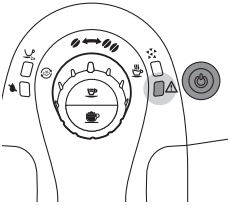

- 警示燈持續亮起，且開關按鈕指示燈熄滅，代表咖啡粉槽已滿。請在咖啡機電源開啟時清空咖啡粉槽。請先確定警示燈閃爍，再重新裝入咖啡粉槽。

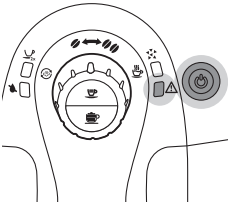

- 警示燈和開關按鈕指示燈持續亮起，代表咖啡豆槽是空的。請重新裝填咖啡豆槽。

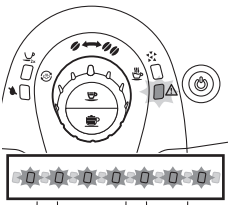

- 警示燈快速閃爍，代表內部管路中沒有水。請將控制鈕轉到熱水圖示，讓熱水從咖啡機流出，直到水持續流動為止。請參閱「使用前準備」單元「將咖啡機加熱」一節。依照步驟 3 和 4 的說明操作。

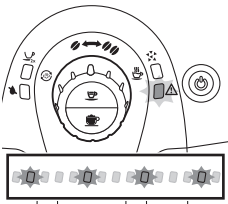

- 警示燈緩慢閃爍，代表未正確裝入沖煮裝置、未裝入咖啡粉槽、維修門蓋為開啟狀態，或控制鈕的位置不正確。請確定已正確裝入沖煮裝置和咖啡粉槽、已關閉維修門蓋，且控制鈕位於正確的位置。如果您無法取出沖煮裝置或將其放回，請先關閉咖啡機電源後再開啟電源。

- 所有燈同時緩慢閃爍，代表咖啡機故障。請關閉咖啡機電源 30 秒後再開啟電源，重複二至三次。如果咖啡機無法重設，請聯絡飛利浦客戶服務中心。

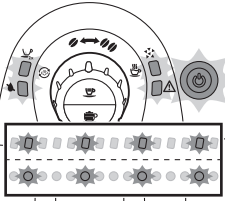

## 疑難排解

本單元概述了使用本機器最常遇到的問題。如果無法利用以下資訊解決遇到的問題，請造訪 [www.philips.com/support](http://www.philips.com/support) 瀏覽常見問題清單，或聯絡您所在國家/地區的飛利浦客戶服務中心。

問題	原因	解決方法
機器下方有積水。	滴盤過滿而溢出。	滴盤已滿指示燈透過滴盤亮起時，請將滴盤清空。進行咖啡機除垢之前，務必先清空滴盤。
	咖啡機未放在水平表面上。	將咖啡機置於水平表面上，以便滴盤已滿指示燈能夠正常運作。
咖啡機無法啟動。	咖啡機未接上電源。	請檢查小插頭是否插入電源插座。接上電源並開啟咖啡機。
咖啡機在進行除垢程序時卡住。	除垢程序中斷或順序不正確。	按下開關按鈕。您可以重新開始除垢程序，或依照「為咖啡機除垢」單元「除垢程序中斷」一節的說明操作。
咖啡不夠燙。	您使用的杯子過冷。	先以熱水清洗來預熱杯子。
	您加了牛奶。	無論您加的牛奶是熱還是冷，多少都會降低咖啡的溫度。
咖啡溫度會隨著時間降低。	咖啡機有一段時間未進行除垢。	為咖啡機除垢。
熱水/蒸氣棒中並未流出熱水或蒸氣。	熱水/蒸氣棒阻塞。	請檢查熱水/蒸氣棒的洞口是否阻塞。如果是，請以大頭針清潔洞口。
	自動奶泡機可能有鱗汙。	清潔自動奶泡機。
	更換濾網 (如果有的話)。	拆除濾網，然後試著再讓熱水流出。如果有效，代表需要更換濾網。
咖啡奶泡太少或咖啡太淡。	研磨機設為粗顆粒。	將研磨機調為較細的設定。
	咖啡調豆不正確。	嘗試其他咖啡調豆。
	咖啡機正在自行調整。	沖煮幾杯咖啡。
	沖煮組件有鱗汙。	清洗沖煮組件。

問題	原因	解決方法
沖煮組件無法拆除。	沖煮組件安裝不正確。	關閉保養門蓋。關閉咖啡機電源後再開啟。靜候咖啡機出現就緒螢幕，然後再拆除沖煮組件。
	代表咖啡粉槽尚未拆除。	請先拆除咖啡粉槽後，再拆除沖煮組件。
	咖啡機還在進行除垢程序。	除垢程序進行時，無法拆除沖煮組件。請先完成除垢程序，才能拆除沖煮組件。
沖煮組件無法裝入。	沖煮組件的位置不正確。	沖煮組件在裝回之前不是位於閒置位置。確定拉桿接觸到沖煮組件的底部，同時也請確定沖煮組件的鉤位於正確的位置。
		請重新裝回滴盤和咖啡粉槽，但不要裝回沖煮組件。關閉保養門蓋，開啟咖啡機電源後再關閉。然後嘗試將沖煮組件裝回。
咖啡機會研磨咖啡豆，但是沒有流出咖啡。	咖啡研磨過細。	將研磨機調為較粗的設定。
	沖煮組件有髒汙。	清洗沖煮組件。
	咖啡流出口有髒汙。	以管路清潔劑清潔咖啡流出口及其洞口。
	咖啡出口輸送管堵塞。	以多功能工具握把或湯匙握把清潔咖啡出口輸送管。
咖啡太淡。	研磨機設為粗顆粒。	將陶瓷咖啡研磨器調至較細的設定 (請參閱「使用咖啡機」單元「調整研磨組細」一節)。
	咖啡機正在自行調整。	沖煮數杯咖啡，讓咖啡機自行調整到新的研磨設定。
	咖啡調豆不正確。	使用其他種類的咖啡豆。
滴盤一下就滿了。	這是正常現象。咖啡機會用水清洗內部管路和沖煮組件。部分的水會經由內部系統直接流入滴盤。	「滴盤已滿」指示燈透過滴盤蓋亮起時，請將滴盤清空。
		在流出口下方放一個杯子，來收集清洗後的水。
杯中的咖啡量不足。	代表內部管路中沒有水。	沖煮組件或其後/下的排水孔可能堵塞。請以溫水清洗沖煮組件，接著仔細清潔上方濾網。並以沾濕的軟布清潔機器內部。
	杯子容量不同。	以記憶功能設定杯子容量。
	沖煮組件有髒汙。	清潔沖煮組件 (請參閱「清潔與維護」單元「清潔沖煮組件」一節)。

問題	原因	解決方法
牛奶沒有奶泡。	自動奶泡機有鱗汙，或組裝/安裝不正確。	清潔自動奶泡機，並確定已經正確組裝或安裝。
	所用的牛奶種類不適合製作奶泡。	牛奶種類會影響奶泡量和奶泡品質。半脫脂牛奶或全脂牛奶的效果較好。

## 回收

- 本產品使用壽命結束時請勿與一般家庭廢棄物一併丟棄。請將該產品放置於政府指定的回收站，此舉能為環保盡一份心力。

## 保固與支援

如需資訊或支援，請造訪：[www.saeco.com/support](http://www.saeco.com/support)，或另行參閱保證書。

如需資訊或支援，請聯絡您所在國家/地區的飛利浦 Saeco 服務專線。聯絡資訊附於另外提供的保證書，或請造訪：[www.saeco.com/support](http://www.saeco.com/support)。

## 訂購保養產品

- Intenza+ 濾網 (CA6702)
- 潤滑油 (HD5061)
- 除垢溶液 (CA6700)

## 技術規格

功能	值/位置
標稱電壓	維修門蓋內側
功率	維修門蓋內側
尺寸 (寬 x 高 x 深)	295 公釐 x 325 公釐 x 420 公釐
重量	6.9 公斤
材質	塑膠
電線長度	0.8 公尺 - 1.2 公尺
水箱容量	1000 毫升
杯子大小	最高 95 公釐
咖啡豆槽容量	170 公克
咖啡粉槽容量	8 塊
幫浦水壓	15 巴
鍋爐	不鏽鋼

功能

值/位置

安全裝置

防過熱保險絲











421946037461



75% recycled paper