

**PHILIPS**

HD7761

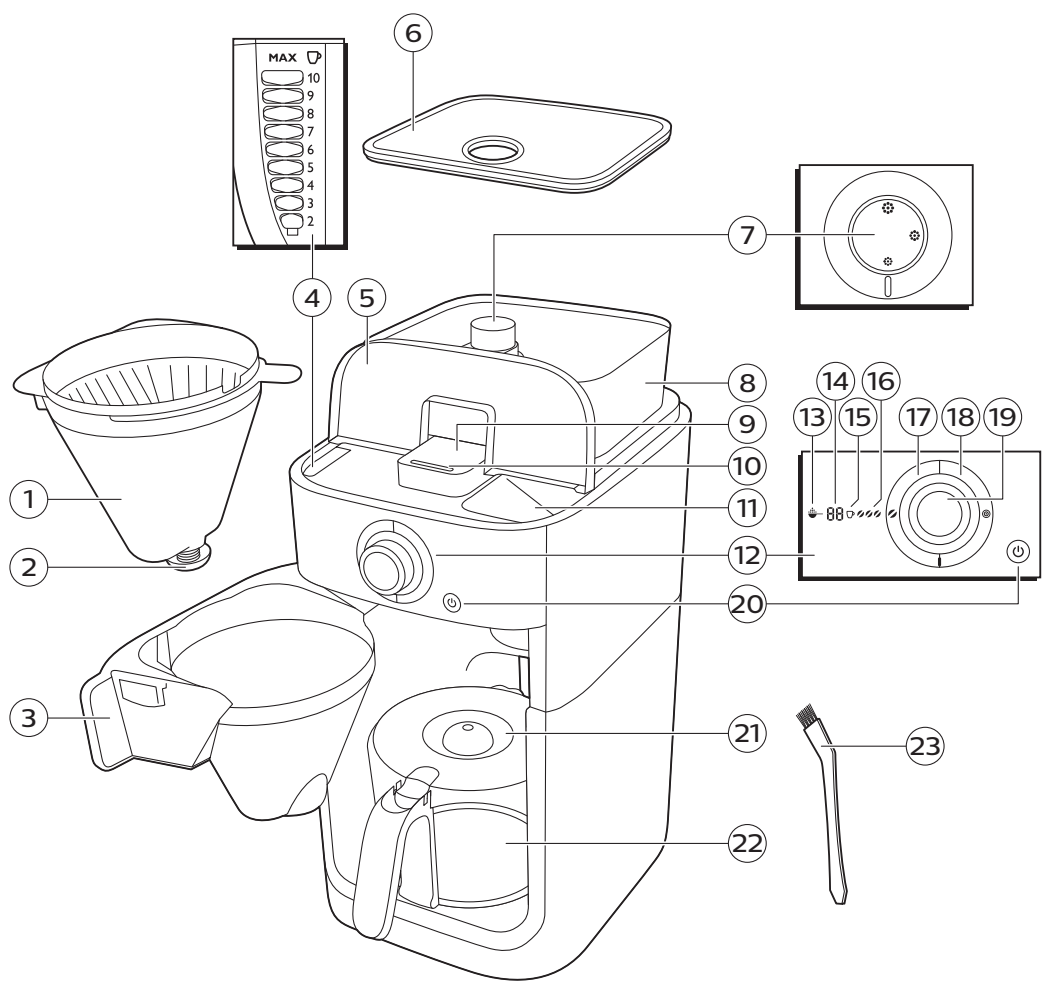







**English 6**  
**繁體中文 14**

## Introduction

Congratulations on your purchase and welcome to Philips! To fully benefit from the support that Philips offers, register your product at [www.philips.com/welcome](http://www.philips.com/welcome).

## General description (Fig. 1)

- 1 Filter basket
- 2 Drip stop
- 3 Filter basket holder
- 4 Water level indicator
- 5 Water reservoir lid
- 6 Bean container lid
- 7 Coarseness knob
- 8 Coffee bean container
- 9 Grinder funnel lid
- 10 Lock of grinder funnel lid
- 11 Water filling hole
- 12 Display
- 13 Pre-ground coffee icon
- 14 Number of cups
- 15 Coffee cup icon
- 16 Strength select coffee bean icon
- 17 Strength select button
- 18 Grinder clean button
- 19 Control knob
- 20 On/off button
- 21 Glass jug lid
- 22 Glass jug
- 23 Bean chute cleaning brush

## Important

### Danger

- Never immerse the appliance in water or any other liquid, nor rinse it under the tap.

### Warning

- Never pour water into the bean container, as this damages the coffeemaker.
- Check if the voltage indicated on the appliance corresponds to the local mains voltage before you connect the appliance.
- Do not use the appliance if the plug, the mains cord or the appliance itself is damaged.
- If the mains cord is damaged, you must have it replaced by Philips, a service center authorized by Philips or similarly qualified persons in order to avoid a hazard.
- Connect the appliance to an earthed wall socket.
- This appliance is not intended for use by persons (including children) with reduced physical, sensory or mental capabilities, or lack of experience and knowledge, unless they have been given supervision or instruction concerning use of the appliance by a person responsible for their safety.
- Children should be supervised to ensure that they do not play with the appliance.
- Keep the appliance and its cord out of the reach of children.
- Only use this appliance for its intended purpose to avoid potential hazard or injury.

- Do not let the mains cord hang over the edge of the table or worktop on which the appliance stands.
- Do not touch the grinding burrs of the of the appliance, especially when the appliance is connected to a wall socket.
- Do not touch the hot surfaces of the appliance when it operates.
- Do not empty the water reservoir by tilting the appliance, as this can damage the appliance. To empty the appliance, follow the instructions for flushing the appliance (see 'Flushing the appliance').
- If a problem occurs that you cannot solve by means of this user manual, contact the Consumer Care Center in your country. If the problem cannot be solved, take the appliance to a service center authorized by Philips for examination or repair. Do not attempt to repair the appliance yourself, otherwise your warranty becomes invalid.

## Caution

- Do not place the appliance on a hot surface and prevent the mains cord from coming into contact with hot surfaces.
- Unplug the appliance if problems occur during grinding or brewing and before you clean it.
- Keep the plug and the wall socket dry.
- Do not lift and move the appliance while it is operating.
- The jug is hot during and after brewing. Always hold the jug by its handle.
- Never use the jug in a microwave oven.
- Wait until the appliance has cooled down before you store it. The hotplate and the coffee jug may be hot.
- After you have unpacked the appliance, make sure it is complete and undamaged. If in doubt, do not use the appliance but contact the Consumer Care Center in your country.
- This machine is intended for normal household use only. It is not intended for use in environments such as staff kitchens of shops, offices, farms or other work environments.

## Electromagnetic fields (EMF)

This Philips appliance complies with all applicable standards and regulations regarding exposure to electromagnetic fields.

## Before first use

### Setting the automatic switch-off time

You can choose how long you want your coffee to stay hot after brewing by adjusting the time after which the appliance automatically switches off. The default automatic switch-off time is 30 minutes. The maximum automatic switch-off time is 120 minutes. To adjust the automatic switch-off time, follow the steps below.

- 1 Make sure that the appliance is switched off but the mains plug is in the wall socket.
- 2 Press the center of the control knob until the display starts flashing.
- 3 Turn the control knob to increase or decrease the time. 1 is 10 minutes, 2 is 20 minutes, 3 is 30 minutes and so on until 12 is 120 minutes.
- 4 Press the center of the control knob to confirm the automatic switch-off time.

Note: The appliance always saves the last setting.

## 8 English

### Flushing the appliance

Always flush the coffeemaker once before first use by following the steps below.

**Warning: Never pour water into the bean container, as this damages the coffeemaker.**

- 1 Open the water reservoir lid. Fill the water reservoir with fresh cold water up to the 8-cup indication (Fig. 2).

Note: Do not put coffee beans or pre-ground coffee in the water reservoir.

- 2 Close the water reservoir lid.
- 3 Put the jug in the appliance (Fig. 3).
- 4 Press the on/off button (Fig. 5). The display lights up and the appliance beeps.
- 5 Press the strength select button (Fig. 4).
- 6 Turn the control knob to choose the pre-ground coffee setting (Fig. 6). The pre-ground coffee icon starts flashing.
- 7 Press the center of the control knob twice to confirm. The appliance starts the flushing process.
- 8 Let the appliance operate until the flushing process is finished. It is finished when the appliance stops beeping.
- 9 Empty the jug.
- 10 Press the on/off button to switch off the appliance.

### Using the appliance

#### Filling the water reservoir

There are indications for 2 to 10 cups (275ml to 1375ml) on the water-level window. You can use these indications to determine how much water to put in the water reservoir. The reflection changes from light to dark for each cup of water added.

- 1 Open the water reservoir lid and fill the water reservoir with the required amount of cold water (Fig. 2).

Note: Do not fill the water reservoir beyond the 10-cup indication.

Note: Make sure that the amount of water you pour into the water reservoir is consistent with the number of cups you want to brew. The coffeemaker uses all the water in the water reservoir.

#### Using coffee beans

**Warning: Always keep the water reservoir lid closed when you fill the coffee bean container with coffee beans. Otherwise coffee beans can fall into the water reservoir and block up the water inlet.**

- 1 Open the coffee bean container lid (Fig. 8).
- 2 Fill the container with coffee beans. Make sure that there are enough coffee beans in the container for the amount of coffee you want to brew (Fig. 9).

Note: Always make sure that the bean container is at least half full.

**Warning: To prevent the grinder from jamming, do not use unroasted or caramelized beans. Use coffee beans instead of espresso beans, as espresso beans may damage the grinder.**



- 3 Open the filter basket holder (Fig. 10).
- 4 Place a paper filter (type 1x4 or no. 4) or the permanent filter in the filter basket (Fig. 11).
- 5 Close the filter basket holder.
- 6 Turn the coarseness knob to select the desired type of grind (from fine to coarse). There are nine grind settings (Fig. 12).

Tip: The coarseness knob allows you to choose between 9 different settings. The icons indicate 3 preselected optimal settings, but you can choose any setting in between. We advise you to experiment with the different grind settings to find out which setting you prefer.

- 7 Press the strength button (Fig. 4). The coffee bean icons start flashing.
- 8 Turn the control knob to select the desired coffee strength: 1 bean for mild coffee, 2 beans for medium-strong coffee or 3 beans for strong coffee.
- 9 Press the center of the control knob to confirm the strength (Fig. 7).
- 10 To select the number of cups, turn the control knob until the desired number of cups flashes on the display. (Fig. 13)

Note: Please keep in mind that the coffeemaker uses all the water in the water reservoir. If you select a number of cups that is smaller than the amount of water, the coffee becomes weaker than you intended.

- 11 Press the center of the control knob to confirm the number of cups (Fig. 7).
- 12 Press the center of the control knob again. The appliance beeps and starts grinding the required amount of coffee beans. When the grinding process is finished, the appliance starts brewing coffee
- 13 Wait until the coffeemaker has stopped beeping before you remove the jug.

Note: After brewing, coffee drips from the filter basket for several seconds.

- 14 The appliance keeps your coffee hot until it switches off automatically. If you do not need your coffee to be kept hot, press the on/off button to switch off the appliance.

## Using pre-ground coffee

If you want to use pre-ground coffee instead of coffee beans, follow the steps below.

- 1 Open the water reservoir lid and fill the water reservoir with the required amount of cold water (Fig. 2).
- 2 Open the filter basket holder (Fig. 10).
- 3 Place a paper filter (type 1x4 or no. 4) or the permanent filter in the filter basket.
- 4 Put pre-ground coffee in the paper filter or in the permanent filter.
- 5 Close the filter basket holder.
- 6 Put the jug in the appliance (Fig. 3).
- 7 Press the on/off button (Fig. 5). The display lights up.
- 8 Press the strength select button (Fig. 4).
- 9 Turn the control knob to choose the pre-ground coffee setting (Fig. 6). The pre-ground coffee icon lights up.
- 10 Press the center of the control knob to confirm (Fig. 7).
- 11 Then press the center of the control knob again to start the brewing process.
- 12 Wait until the coffeemaker has stopped beeping before you remove the jug.

Note: After brewing, coffee drips from the filter basket for several seconds.

- 13 The appliance keeps your coffee hot until it switches off automatically. If you do not need your coffee to be kept hot, press the on/off button to switch off the appliance.

## 10 English

### Drip stop function

The drip stop function enables you to remove the jug from the coffeemaker before the brewing process is finished. When you remove the jug, the drip stop stops the flow of coffee into the jug.

**Note:** The brewing process does not stop when you remove the jug. If you do not put the jug back in the appliance within 20 seconds, the filter basket overflows.

## Cleaning and maintenance

### Cleaning after every use

**Never immerse the appliance in water or any other liquid, nor rinse it under the tap.**

- 1 Remove the mains plug from the wall socket.
- 2 Wipe the outside of the coffeemaker with a damp cloth.
- 3 Clean the filter basket and the permanent filter with hot water and some washing-up liquid or clean them in the dishwasher.

### Cleaning the grinder funnel

**Important:** Clean the grinder funnel every 1 to 2 weeks to prevent clogging with ground coffee. This is easily and quickly done by following the steps below.

**Note:** Make sure the coffee bean container is empty before you start the cleaning procedure.

- 1 Press the on/off button to switch off the appliance (Fig. 14).
- 2 Open the filter basket holder (Fig. 10).
- 3 Place a paper filter (type 1x4 or no. 4) or the permanent filter in the filter basket (Fig. 11).
- 4 Close the filter basket holder.
- 5 Use the end of the bean chute cleaning brush to open the grinder funnel lid (Fig. 15).
- 6 Press and hold the grinder clean button for 4 seconds (Fig. 16). The grinder starts cleaning itself.
- 7 When the grinder has stopped cleaning, use the bean chute cleaning brush to brush ground coffee residues into the lower part of the funnel (Fig. 17). The ground coffee residues fall into the filter basket.
- 8 Close the lid of the grinder funnel.
- 9 Remove the paper filter or permanent filter with the ground coffee residues.

### Descaling the coffeemaker

Descal the coffeemaker when you notice excessive steaming or when the brewing time increases. It is advisable to descale the coffeemaker every two months. Only use white vinegar to descale, as other products may cause damage to the coffeemaker. For more information on descaling, see [www.philips.com/descale-coffeemaker](http://www.philips.com/descale-coffeemaker).

**Warning:** Never use vinegar with an acetic acid content of 8% or more, natural vinegar, powder descalers or tablet descalers to descale the appliance, as this may cause damage.

- 1 Open the water reservoir lid.

- 2 Fill the water reservoir up to 10 cup indication with white vinegar (4% acetic acid).
- 3 Place a paper filter (type 1x4 or no. 4) or the permanent filter in the filter basket and close the filter basket holder.
- 4 Put the empty jug in the appliance.
- 5 Put the mains plug in the wall socket.
- 6 Press the on/off button to switch on the appliance (Fig. 5). The display lights up.
- 7 Press the strength select button and turn the control knob to choose the pre-ground coffee setting (Fig. 6).
- 8 Press the center of the control knob twice to confirm and start the brewing process.
- 9 Wait until half of the vinegar has flowed into the jug. Then press the on/off button to interrupt the brewing process. Let the vinegar act for at least 15 minutes.
- 10 Press the on/off button to switch the coffeemaker back on.
- 11 Press the center of the control knob twice to let the appliance complete the brewing process (Fig. 18).
- 12 Empty the jug and remove the paper filter or the permanent filter with the scale residues.
- 13 Fill the water reservoir with fresh cold water and press the center of the control knob twice to start another brewing process (Fig. 18). Let the coffeemaker complete the entire brewing process and empty the jug.

Note: If necessary repeat step 14 until the water that comes out of the appliance no longer tastes or smells of vinegar.

- 14 Clean the filter basket and the jug with hot water and some washing-up liquid.
- 15 Press the on/off button on the front of the appliance to switch off the appliance (Fig. 14).

## Warranty and support

If you need information or support, please visit [www.philips.com/support](http://www.philips.com/support) or read the international warranty leaflet.

## Ordering accessories

To buy accessories or spare parts, visit [www.philips.com/parts-and-accessories](http://www.philips.com/parts-and-accessories) or go to your Philips dealer. You can also contact the Philips Consumer Care Center in your country (see the international warranty leaflet for contact details).

## Recycling

- Do not throw away the product with the normal household waste at the end of its life, but hand it in at an official collection point for recycling. By doing this, you help to preserve the environment.
- Follow your country's rules for the separate collection of electrical and electronic products. Correct disposal helps prevent negative consequences for the environment and human health.

## Troubleshooting

This chapter summarizes the most common problems you could encounter with the appliance. If you are unable to solve the problem with the information below, visit [www.philips.com/support](http://www.philips.com/support) for a list of frequently asked questions or contact the Consumer Care Center in your country.

Problem	Solution
---------	----------

## 12 English

The appliance does not work.	Put the mains plug in the wall socket and press the on/off button to switch on the appliance.
	Make sure that the voltage indicated on the appliance corresponds to the local mains voltage.
	Fill the water reservoir with water.
	Close the lid of the grinder funnel.
The grinder does not work or does not work properly.	Make sure that you did not select pre-ground coffee. If the symbol for pre-ground coffee is visible on the display, you selected pre-ground coffee.
	Clean the grinder funnel by following the instructions (see 'Cleaning the grinder funnel').
When I use the grinder, the coffee is too weak.	Make sure that the number of cups you selected is consistent with the amount of water in the water reservoir. Please keep in mind that the coffeemaker uses all the water in the water reservoir.
	Use the strength button to set the coffee strength to 'strong'.
	Use coffee beans of a stronger blend or flavor.
When I use pre-ground coffee, the coffee is too weak.	Make sure that the amount of pre-ground coffee in the filter is consistent with the amount of water in the water reservoir. Please keep in mind that the appliance uses all the water in the water reservoir.
	Use ground coffee of a stronger blend or flavor.
	To increase the coffee strength, increase the amount of pre-ground coffee or decrease the amount of water.
The filter overflows when I remove the jug from the appliance while it is brewing coffee.	If you remove the jug for more than 20 seconds during the brewing process, the drip stop causes the filter basket to overflow. Also note that the coffee does not reach its full taste before the end of the brewing process. Therefore we advise you not to remove the jug and pour out the coffee before the end of the brewing process.
The appliance continues to drip long after the brewing process has ended.	The dripping is caused by condensation of steam. It is completely normal that the appliance drips for some time.
	If the dripping does not stop, the drip stop may be clogged. To clean the drip stop, open the filter basket holder and take out the filter basket. Rinse the filter basket and the drip stop under the tap.
The coffee is not hot enough.	The coffee in the jug cools down faster if you brew only a few cups. The coffee stays hot longer if you brew 10 cups, which is a full jug.
	Descal the appliance (see 'Descaling the coffeemaker').
The appliance does not start cleaning the grinder funnel.	Make sure that the appliance is plugged in.

Open the lid of the grinder funnel before you press and hold the coffee strength button.

---

Press and hold the coffee strength button for 4 seconds until the grinder starts cleaning itself.

---

The appliance works but makes a beeping sound.

Please check if the lid of the grinder funnel is closed properly.

---

The coffee beans seem to be used up quickly.

To brew a perfect cup of coffee, the appliance needs a certain amount of ground coffee. The amount of coffee beans the appliance uses to obtain the optimal amount of ground coffee per cup is normal.

---

## 14 繁體中文

# 簡介

感謝您購買本產品。歡迎來到飛利浦的世界！為充分享受飛利浦為您提供的好處，請至下列位址註冊產品：[www.philips.com/welcome](http://www.philips.com/welcome)。

## 一般說明 (圖 1)

- 1 網籃
- 2 特殊底盤防漏功能
- 3 網籃架
- 4 水位顯示
- 5 水箱蓋
- 6 咖啡豆槽上蓋
- 7 研磨度旋鈕
- 8 咖啡豆槽
- 9 研磨斗蓋
- 10 研磨斗蓋鎖
- 11 注水口
- 12 顯示幕
- 13 預磨咖啡粉圖示
- 14 杯數
- 15 咖啡杯圖示
- 16 濃度選擇咖啡豆圖示
- 17 濃度選擇按鈕
- 18 研磨器清理按鈕
- 19 控制鈕
- 20 開關按鈕
- 21 玻璃壺蓋
- 22 玻璃壺
- 23 咖啡豆斜槽清潔刷

## 重要事項

### 危險

- 請勿讓產品浸入水或其他液體中，也不要在水龍頭下沖洗。

### 警示

- 請勿將水倒入咖啡豆槽，以免損壞咖啡機。
- 在您連接電源之前，請檢查本地的電源電壓是否與產品所標示的電壓相符。
- 當插頭、電線或產品本身受損時，請勿使用產品。
- 如果電線損壞，則必須交由飛利浦、飛利浦授權之服務中心，或是具備相同資格的技師更換，以免發生危險。
- 將產品連接到有接地的電源插座。
- 本產品不適合供下列人士 (包括孩童) 使用：身體官能或心智能力退化者，或是經驗與使用知識缺乏者。他們需要有人負責其安全的人員在旁監督，或指示產品的使用方法，方可使用。
- 孩童使用本產品須有人監督，以免孩童將本產品當成玩具。
- 請勿讓孩童接觸產品與電線。
- 本產品僅限用於相關用途，以免造成意外風險或受傷。
- 請勿讓電源線懸掛在產品放置的餐桌或流理台邊緣。
- 請勿碰觸本產品的研磨刀片，尤其是插入牆上插座時。

- 產品運作時，請勿碰觸產品的高溫表面。
- 請勿傾斜本產品以清空水箱，否則可能會損害本產品。若要清空本產品，請遵循沖洗本產品(見'沖洗產品')的說明。
- 若無法依使用手冊解決所發生的問題，請聯絡您所在國家/地區的客戶服務中心。如果無法解決問題，請將本產品送至飛利浦授權的維修中心進行檢查或修理。請勿嘗試自己動手修理本產品，否則產品保固將失效。

## 警告

- 請勿將產品置放在高溫表面，並避免電源線與高溫表面接觸。
- 若清洗前、研磨期間或沖煮咖啡時發生問題，請先拔下插頭。
- 插頭及插座請保持乾燥。
- 產品運作中請勿舉起或移動產品。
- 在咖啡沖煮期間或沖煮完成後，咖啡壺會很燙。取用咖啡壺時，請務必抓取把手。
- 切勿將咖啡壺用於微波爐。
- 在進行收納之前，請先等候本產品完全冷卻。加熱盤與咖啡壺可能很燙。
- 拆開產品包裝後，請務必確認產品完整且無損壞。如有疑問，請勿使用產品，並與您所在國家/地區的客戶服務中心聯絡。
- 本咖啡機僅供一般家用，並非用於商店的員工廚房、辦公室、農舍或其他工作場所。

## 電磁波 (EMF)

本Philips產品符合所有電磁場暴露的相關適用標準和法規。

## 第一次使用前

### 設定自動關機時間

您可以調整咖啡機自動關機時間，選擇在沖煮之後想讓咖啡保溫多長時間。預設自動關機時間為 30 分鐘。自動關機時間最高可調至 120 分鐘。若要調整自動關機時間，請依照下列步驟操作。

- 1 確認咖啡機已關機，但電源插頭仍插入牆上插座中。
- 2 按壓控制鈕中央，直到顯示螢幕開始閃爍。
- 3 旋轉控制鈕以增加或減少時間。1 是 10 分鐘、2 是 20 分鐘、3 是 30 分鐘並依此類推，最高 12 是 120 分鐘。
- 4 按壓控制鈕中央，可確認自動關機時間。

注意：本產品一律儲存最後的設定。

## 沖洗產品

第一次使用前，請務必依照下列步驟，先以清水沖洗咖啡機。

**警告：請勿將水倒入咖啡豆槽，以免損壞咖啡機。**

- 1 打開水箱蓋。將乾淨的冷水注入水箱至 8 杯刻度(圖 2)。

注意：請勿將咖啡豆或預磨咖啡粉放入水箱中。

- 2 關上水箱蓋。
- 3 將咖啡壺放入裝置(圖 3)中。
- 4 按下開關按鈕(圖 5)。顯示螢幕會亮起，咖啡機會發出嗶聲。
- 5 按下濃度選擇按鈕(圖 4)。

## 16 繁體中文

- 轉動控制鈕，選擇預磨咖啡粉設定 (圖 6)。預磨咖啡粉圖示會開始閃爍。
- 按壓控制鈕中央兩次以確認。咖啡機會開始沖洗程序。
- 讓咖啡機自行運作，直到沖洗程序完成。咖啡機停止發出嗶聲時，表示已完成。
- 將咖啡壺裡的水倒掉。
- 按下開關按鈕，讓咖啡機關機。

# 使用本產品

## 水箱加水

水位視窗上有 2 到 10 杯 (275 毫升到 1375 毫升) 的刻度顯示。您可以使用這些刻度判斷水箱要倒入多少水。每加一杯水量，對應的杯數顯示格便會由亮轉暗。

- 打開水箱蓋，往水箱注入所需的冷水量 (圖 2)。

注意：水箱加水不得超過 10 杯的水量。

注意：請確認倒入水箱的水量與您想要沖煮的杯數一致。咖啡機會用盡儲水箱中所有的水。

## 使用咖啡豆

**警告：往咖啡豆槽倒入咖啡豆時，務必關上水箱蓋，否則咖啡豆可能掉入水箱，阻塞入水口。**

- 打開咖啡豆槽蓋 (圖 8)。
- 將咖啡豆倒入咖啡豆槽。請確認咖啡豆槽中是否有足夠的咖啡豆，可沖煮 (圖 9) 您所要的咖啡量。

注意：確認咖啡豆槽至少必須半滿。

**警告：為避免研磨器阻塞，請勿使用未烘焙或焦糖化的咖啡豆。義式濃縮咖啡豆可能造成機器損壞，因此建議您改為使用咖啡豆。**

- 打開網籃架 (圖 10)。
- 將一張濾紙 (1x4 型或 4 號) 或永久濾網放入網籃 (圖 11) 中。
- 蓋上網籃架。
- 轉動研磨度旋鈕，選擇您想要的研磨度 (研磨粗細)。一共有九種研磨設定 (圖 12)。

提示：研磨度旋鈕可讓您選擇 9 種不同的設定。圖示顯示 3 種預設的最佳設定，但您可選擇其間任何設定。建議您稍微體驗一下不同的研磨設定，以便找出最適合您的設定。

- 按下濃度按鈕 (圖 4)。咖啡豆圖示會開始閃爍。
- 轉動控制鈕，選擇想要的咖啡濃度：1 顆咖啡豆代表較淡、2 顆咖啡豆代表適中，或 3 顆咖啡豆代表濃郁咖啡。
- 按壓控制鈕中央，以確認濃度 (圖 7)。
- 轉動控制鈕來選擇杯數，直到想要的杯數在顯示幕 (圖 13) 上閃爍為止。

注意：請記住，咖啡機會用盡水箱中所有的水。如果您選擇的杯數低於水量，將會使咖啡變淡。

- 按壓控制鈕中央即可確認杯 (圖 7) 數。
- 再按一次控制鈕中央。咖啡機會發出嗶聲，並開始研磨所需的咖啡豆。研磨程序完成後，咖啡機就會開始沖煮咖啡。
- 請等到咖啡機停止發嗶聲後，再取出咖啡壺。

注意：咖啡沖煮完畢幾秒內，網籃可能仍會滴下咖啡。

- 咖啡機會讓咖啡一直保溫到自動關機為止。如果不需要保持咖啡熱度，請按下開關按鈕，讓咖啡機關機。



## 使用預磨咖啡粉

若您想要使用預磨咖啡粉而非咖啡豆，請依照下列步驟操作。

- 1 打開水箱蓋，往水箱注入所需的冷水量 (圖 2)。
- 2 打開網籃架 (圖 10)。
- 3 將一張濾紙 (1x4 型或 4 號) 或永久濾網放入網籃中。
- 4 將預磨咖啡粉放入濾紙或永久濾網中。
- 5 蓋上網籃架。
- 6 將咖啡壺放入裝置 (圖 3)中。
- 7 按下開關按鈕 (圖 5)。顯示幕會亮起。
- 8 按下濃度選擇按鈕 (圖 4)。
- 9 轉動控制鈕，選擇預磨咖啡粉設定 (圖 6)。預磨咖啡粉圖示會亮起。
- 10 按壓控制鈕中央以確認 (圖 7)。
- 11 然後再按一次控制鈕中央，即可開始沖煮程序。
- 12 請等到咖啡機停止發聲後，再取出咖啡壺。

注意：咖啡沖煮完畢幾秒內，網籃可能仍會滴下咖啡。

- 13 咖啡機會讓咖啡一直保溫到自動關機為止。如果不需要保持咖啡熱度，請按下開關按鈕，讓咖啡機關機。

## 防漏功能

特殊底盤防漏功能可讓您在沖煮程序結束之前，從咖啡機取出咖啡壺而不讓咖啡漏出。當您取出咖啡壺時，防漏裝置會阻止咖啡流入咖啡壺。

注意：在您取出咖啡壺時，沖煮程序並未停止。若您未在 20 秒內放回咖啡壺，咖啡會從網籃溢出。

## 清潔與維護

### 每次使用後均需清潔

**請勿讓產品浸入水或其他液體中，也不要在水龍頭下沖洗。**

- 1 從插座拔下電源插頭。
- 2 用濕布擦拭咖啡機外部。
- 3 網籃和永久濾網可以用熱水和少許清潔劑，或放入洗碗機中清洗。

### 清潔研磨斗

**重要事項：每隔 1 到 2 週清潔研磨斗，以免咖啡粉阻塞。請依照下列步驟操作，即可輕鬆迅速完成。**

注意：確定咖啡豆槽已清空後，再開始清潔程序。

- 1 按下開關按鈕，讓咖啡機 (圖 14)關機。
- 2 打開網籃架 (圖 10)。
- 3 將一張濾紙 (1x4 型或 4 號) 或永久濾網放入網籃 (圖 11)中。
- 4 蓋上網籃架。
- 5 使用咖啡豆斜槽清潔刷尾端打開研磨斗蓋 (圖 15)。
- 6 按住研磨器清潔按鈕 4 秒鐘 (圖 16)。研磨器隨即自行清潔。
- 7 研磨器停止清潔時，請用咖啡豆斜槽清潔刷，將殘留的咖啡粉掃往研磨斗 (圖 17)下方。咖啡粉殘渣會掉入網籃中。

## 18 繁體中文

- 8 蓋上研磨斗的蓋子。
- 9 取下裝有殘餘咖啡粉的濾紙或永久濾網。

### 咖啡機除垢

如發現蒸氣過多或沖煮時間加長，請為咖啡機除垢。建議每兩個月為咖啡機除垢一次。請僅使用白醋除垢，因為其他產品可能會對咖啡機造成損害。如需更多關於除垢的資訊，請參閱[www.philips.com/descale-coffeemaker](http://www.philips.com/descale-coffeemaker)。

**警告：請勿使用醋酸高於 8% 的醋類、天然醋、粉狀除垢劑或除垢錠為產品除垢，如此可能會損害產品。**

- 1 打開水箱蓋。
- 2 將白醋 (4% 醋酸) 倒入水箱直到 10 杯刻度。
- 3 將一張濾紙 (1x4 型或 4 號) 或永久濾網放入網籃中，然後蓋上網籃架。
- 4 將空咖啡壺放入咖啡機中。
- 5 將電源插頭插入牆上插座。
- 6 按下開關按鈕，開啟產品電源。顯示幕會亮起。
- 7 按下濃度選擇按鈕並轉動控制鈕，選擇預磨咖啡粉設定 (圖 6)。
- 8 按壓控制鈕中央兩次以確認，然後開始沖煮程序。
- 9 等到白醋過半流入咖啡壺中之後，按下開關按鈕停止沖煮程序，靜置至少 15 分鐘的時間，讓白醋產生作用。
- 10 按下開關按鈕，再次開啟咖啡機。
- 11 按壓控制鈕中央兩次，讓咖啡機完成沖煮程序 (圖 18)。
- 12 將咖啡壺裡的醋水倒掉，並取下有水垢殘留物的濾紙或永久濾網。
- 13 將乾淨的冷水注入水箱，然後按壓控制鈕中央兩次，再進行一次沖煮程序 (圖 18)。讓咖啡機完成整個沖煮程序，然後將咖啡壺裡的水倒掉。

注意：如有需要，請重複步驟 14，直到產品流出的水不再有白醋的味道。

- 14 網籃和咖啡壺可以用熱水和少許清潔劑清洗。
- 15 按下咖啡機前方的開關按鈕，讓咖啡機 (圖 14) 關機。

### 保固與支援

如需資訊或支援，請造訪：[www.philips.com/support](http://www.philips.com/support)，或參閱全球保固說明書。

### 訂購配件

若要購買配件或備用零件，請造訪 [www.philips.com/parts-and-accessories](http://www.philips.com/parts-and-accessories)，或洽詢您的飛利浦經銷商。您也可以聯絡您所在國家/地區的飛利浦客戶服務中心 (詳細聯絡資料請參閱全球保固說明書)。

### 回收

- 本產品使用壽命結束時請勿與一般家庭廢棄物一併丟棄。請將該產品放置於政府指定的回收站，此舉能為環保盡一份心力。
- 請按照您所在國家/地區的規定，分類與回收電子電器產品。正確處理廢棄物有助避免對環境和人類健康的負面影響。

## 疑難排解

本章概述了使用本產品最常遇到的問題。如果無法利用以下資訊解決遇到的問題，請造訪 [www.philips.com/support](http://www.philips.com/support) 瀏覽常見問題清單，或聯絡您所在國家/地區的飛利浦客戶服務中心。

問題	解決方法
本產品無法運作。	將電源插頭插入供電插座，然後按下開關按鈕，啟動本產品。 請確認本產品的電壓與當地電壓相符。 將水箱注滿水。 蓋上研磨斗的蓋子。
研磨器無法運作或無法正常運作。	請確認您並未選擇預磨咖啡粉。如果在顯示幕上看見預磨咖啡粉符號，表示您已選擇預磨咖啡粉。 遵照下列說明 (見 '清潔研磨斗') 清潔研磨斗。
使用研磨器製作的咖啡味道太淡。	請確認所選杯數與水箱中的水量相符一致。請記住，咖啡機會用盡水箱中所有的水。 使用濃度選擇按鈕，將咖啡濃度設定為「濃」。 使用濃度或風味更濃烈的咖啡豆。
使用預先研磨咖啡粉製作的咖啡味道太淡。	請確認濾網中的預磨咖啡粉量與水箱中的水量一致。請記住，咖啡機會用盡水箱中所有的水。 使用濃度或風味更濃烈的咖啡粉。 若要提升咖啡濃度，請增加咖啡粉量或減少水量。
我在沖煮過程中移開咖啡壺時，咖啡自濾網中滿溢出來。	如果您在沖煮期間移開咖啡壺超過 20 秒，防漏裝置會導致網籃中的咖啡溢出。另請注意，在沖煮程序結束前，咖啡尚未達到最完整的風味。因此建議您，沖煮程序結束之前，不要將咖啡壺取出並倒咖啡。
在沖煮程序結束之後一段時間，產品仍繼續滴水。	滴水是因為蒸氣凝結而造成。咖啡機持續滴水一陣子是完全正常的現象。 如果滴水現象沒有停止，可能是防漏裝置堵塞。若要清洗防漏裝置，請打開網籃架，並取出網籃，將網籃與防漏裝置放在水龍頭下沖洗。
咖啡不夠燙。	如果您僅沖煮數杯咖啡，咖啡壺內的咖啡將較快冷卻。但如果您沖煮 10 杯咖啡 (滿壺)，則咖啡可保溫較久。 為咖啡機 (見 '咖啡機除垢') 除垢。
咖啡機無法開始清潔研磨斗。	請確認插頭已經插上。 按住咖啡濃度按鈕之前，先打開研磨斗的蓋子。 按住咖啡濃度按鈕 4 秒，直到研磨器開始自行清潔。
產品運作時發出嗶聲。	請檢查研磨斗蓋是否已關妥。
咖啡豆似乎消耗過快。	要沖煮一杯完美的咖啡，咖啡機需要一定數量的咖啡粉。本產品為研磨出理想的咖啡粉量而消耗的咖啡豆量，實屬正常範圍。

## 20 繁體中文

設備名稱：飛利浦美式全自動咖啡機，型號（型式）：HD7761						
單元	限用物質及其化學符號					
	鉛 (Pb)	汞 (Hg)	鎘 (Cd)	六價鉻 (Cr (VI) )	多溴聯苯 (PBB)	多溴二苯醚 (PBDE)
主體	○	○	○	○	○	○
控制面板	○	○	○	○	○	○
磨豆電機	-	○	○	○	○	○
機板	-	○	○	○	○	○
電源線	-	○	○	○	○	○
備考1. “超出0.1 wt %”及“超出0.01 wt %” 係指限用物質之百分比含量超出百分比 含量基準值。						
備考2. “○” 係指該項限用物質之百分比含量未超出百分比含量基準值。						
備考3. “-” 係指該項限用物質為排除項目。						

\_ |

| \_

\_ |

| \_

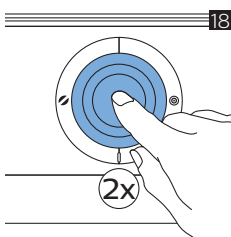
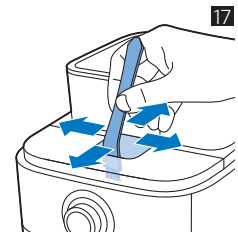
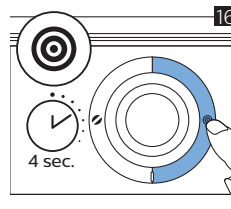
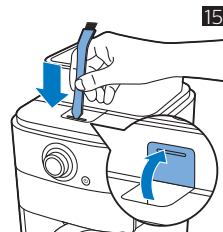
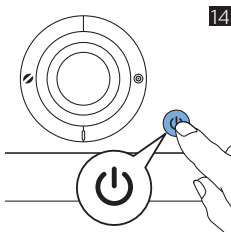
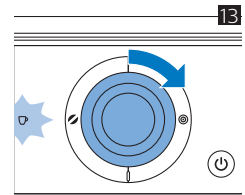
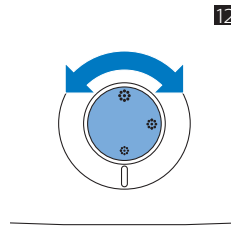
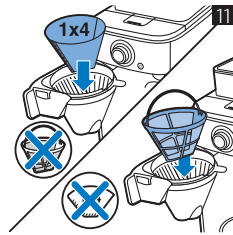
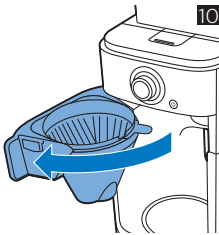
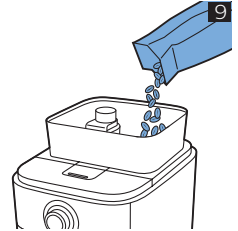
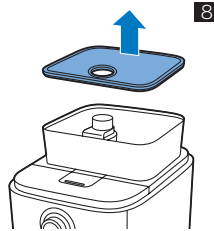
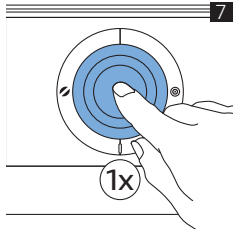
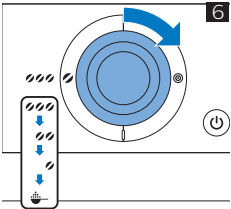
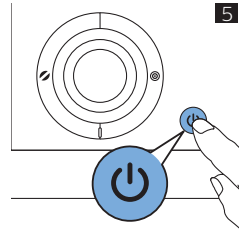
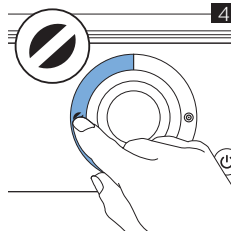
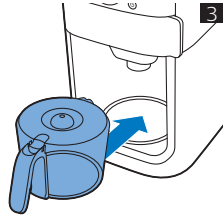
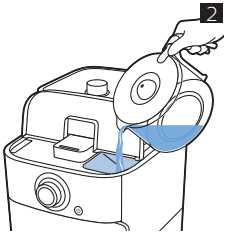

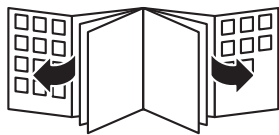

4222.200.0737.2 19/9/2018

> 75% 循环再造纸

保留备用



>75% recycled paper  
>75% papier recyclé