

Installation Guide

VHM Wall Mount Kit for Philips MX600/700/800 and MP60/70 IntelliVue

The purpose of this guide is to:

1. Describe attachment of Table Top Mount to Mounting Adapter (page 2).
2. Describe mounting of VHM Arm in the Wall Channel (page 2).
3. Describe attachment of Down Post to VHM Arm (page 3).
4. Describe mounting of Flexible Module Server (FMS) on Down Post (page 3).
5. Describe counterbalance adjustment (page 4).
6. Describe Operation and Adjustment of VHM Arm (page 5 – 6).

Parts Reference

The following parts and hardware are included in this installation kit (hardware not shown):

Item #	Description	Qty
1	VHM Arm with Mounting Adapter	1
2	Locking Lever, Height Adjustment	1
3	Cable Guide	1
4	6" Down Post Kit	1
5	#10-32 x 3/8" Socket Head Cap Screw (SHCS)	3
6	M6 x 8mm FHMS	2
7	M6 x 12mm FHMS	1
8	5/32" [4mm] Hex Wrench	1
9	1/8" Hex Wrench	1
10	1/2" Socket Wrench	1
11	Wall Channel Cover, 16" (instructions included)	1

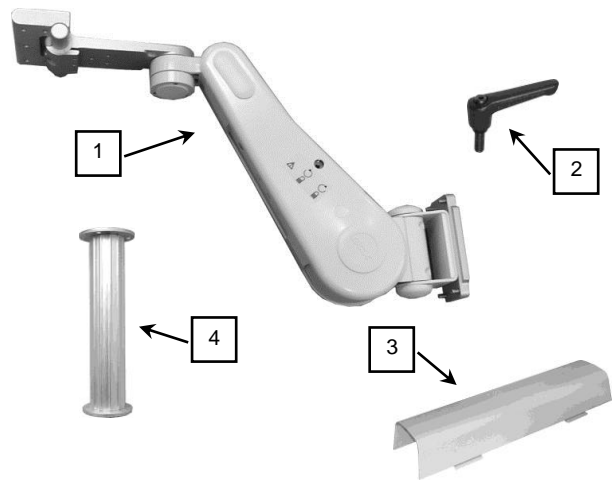

Tools Required: 5/32" and 1/8" hex wrenches (provided), Phillips screwdriver (not provided), and 1/2" [13mm] socket wrench (provided).

WARNING!

The VHM Arm contains a strong spring which is used to counterbalance the weight of the mounted device. The Arm housing should never be disassembled by non-GCX personnel. Additionally, the mounted device should only be removed with the Arm in its highest vertical position, and with the Height Locking Lever engaged. Failure to follow these guidelines could result in serious injury.

Before mounting the Arm:

1. Note that this arm has a wide range of motion both up/down and side to side. Please consider carefully the device being mounted and the proximity of the assembly to other equipment, hospital personnel, and the patient. GCX recommends that the hospital's risk management personnel verify the appropriateness of the application prior to installation and use.
2. If assistance is needed regarding an application, please contact a GCX product specialist at (800) 228-2555.

Attaching the Philips-supplied Table Top Mount to the Mounting Adapter

1. Fasten Philips-supplied Table Top Mount to Mounting Adapter with one (1) M6 x 12mm FHMS and two (2) M6 x 8mm FHMS (see below).

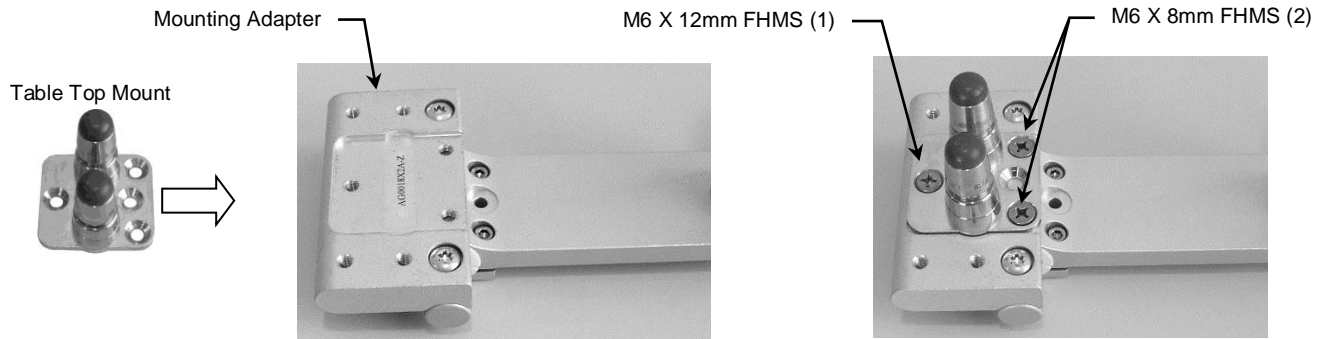

Mounting VHM Arm in Wall Channel

1. Thread the Height Locking Lever into the mounting hole in the right side of the Arm. The Lever operates by turning clockwise to tighten or counterclockwise to loosen. Ensure that the Locking Lever is in the locked position before mounting the Arm in the channel.

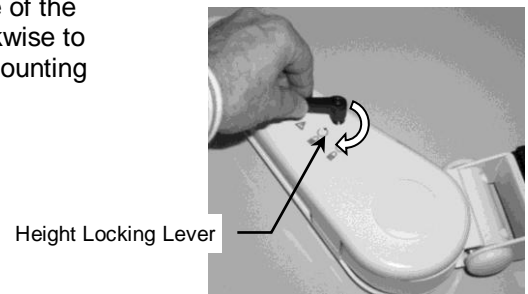

2. While supporting the bottom of the Arm, guide the Slide into the top of the wall channel (below left) and move Arm to required mounting position.
3. Using the 1/8" hex wrench provided, tighten four (4) set screws in Slide to secure position of Arm (below right).

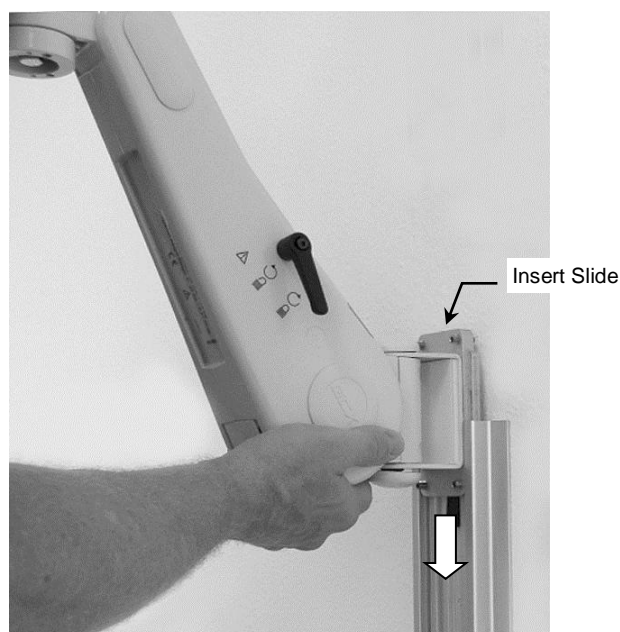

4. Mount the monitor in accordance with Philips Table Top Mount instructions. Attach Down Post if required (see procedure below) and proceed to "Counterbalance Adjustment" on page 4. **Installation Note:** Counterbalance Adjustment must be performed after monitor and FMS are mounted on the Arm.

Attaching the Down Post to the Arm

The Down Post is used for mounting the Flexible Module Server (FMS). Skip this procedure if your IntelliVue monitoring system does not require a Down Post or FMS.

1. Align three (3) mounting holes in Lower Post Disc with three (3) threaded holes in Swivel Cup (below left). Using the 5/32" hex wrench provided, fasten Post to Swivel Cup with three (3) #10-32 x 3/8" SHCS.

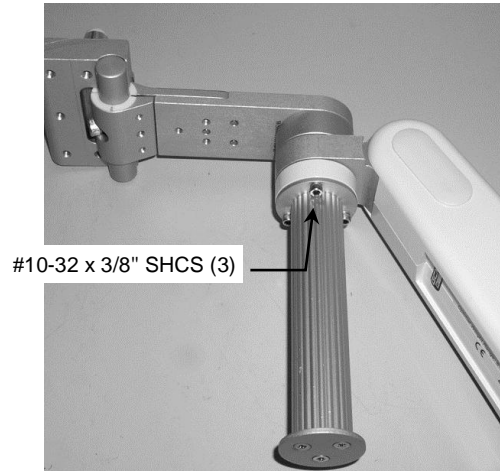
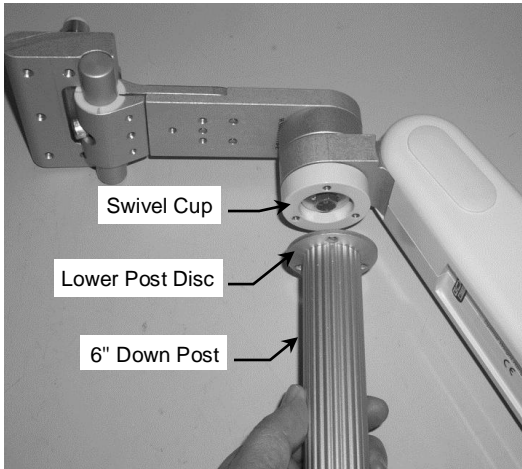

Mounting the Flexible Module Server (FMS) on the Down Post

1. Attach the FMS to the Down Post by placing the Clamp around the Down Post and tightening the knob.

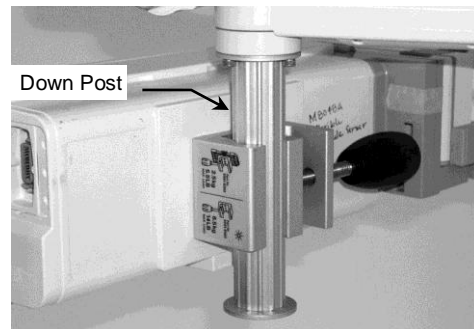
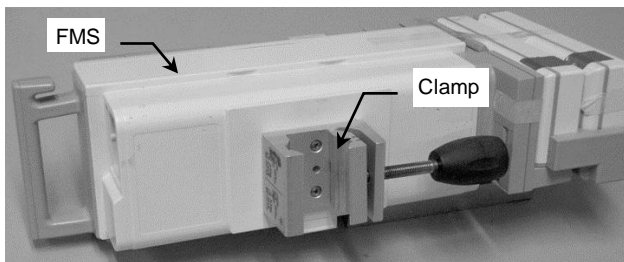

Counterbalance Adjustment



WARNING: Do not attempt counterbalance adjustment unless the instrument and accessories are mounted on the Arm. Use caution while performing this procedure.

The VHM Arm must be adjusted to counterbalance the mounted instrument throughout the Arm's vertical range of motion. When properly counterbalanced, the VHM Arm will maintain its height without engagement of the Height Locking Lever or Locking Knob. Because instrument weights vary, adjustment will typically be required to achieve optimal performance. A 1/2" [13mm] socket wrench is provided for this critical adjustment.

To adjust counterbalance:

1. Grasp the Arm behind the mounted instrument(s) and carefully move the Arm to a horizontal position that allows access to the Adjuster Cover (below left). Lock Arm in horizontal position.
2. Open the Adjuster Cover by inserting a flat blade screwdriver in the slot at the rear of the Cover and prying upward. If necessary unlock and readjust the Arm until the Counterbalance Adjuster bolt is accessible through the Adjuster Cover (below center). Lock Arm when Counterbalance Adjuster is accessible.
3. With the 1/2" [13mm] socket wrench on the Adjuster, carefully unlock the arm. Turn the Adjuster *counterclockwise* (CCW) to increase counterbalance force, or *clockwise* (CW) to decrease counterbalance force. Counterbalance is correctly adjusted when the mounted instrument can be moved up or down with minimal force and does not rise or fall after releasing the Arm.

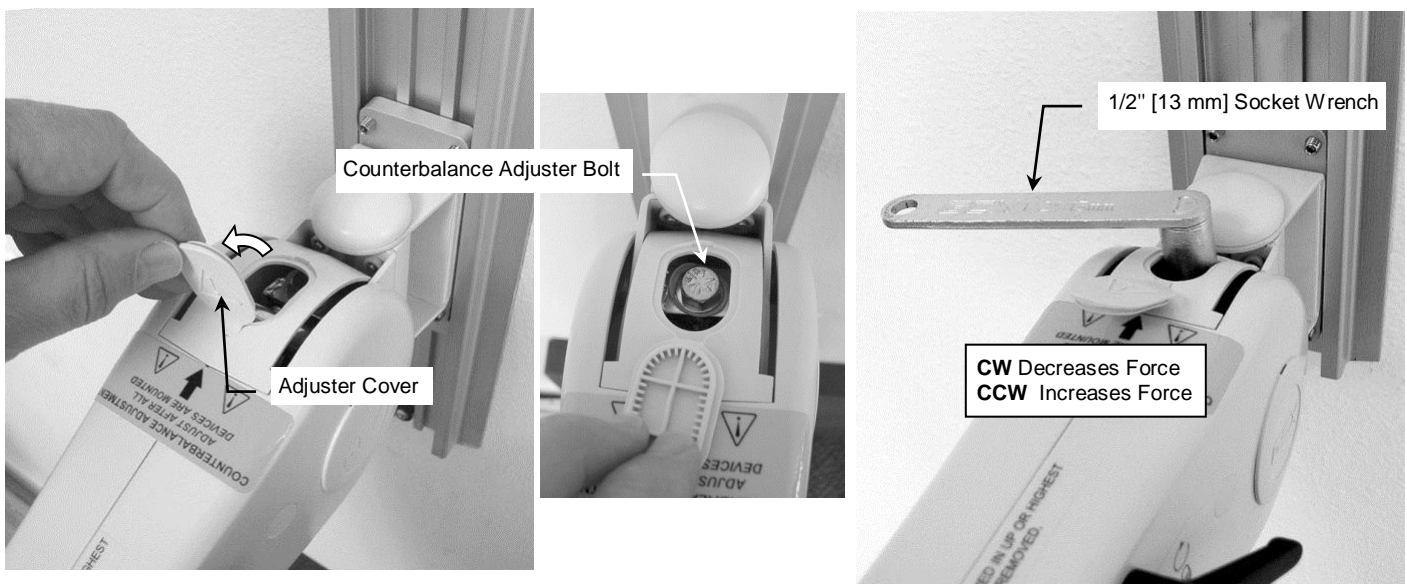

4. Close the Adjuster Cover.

Cable Management

A Cable Guide is provided to facilitate routing of cables along the underside of the arm. Squeeze the Cable Guide until its edges snap into the grooves in the bottom surface of the arm. Leave some extra cable loose at the front and rear of the arm to prevent cable binding, connector damage, or Cable Guide damage.

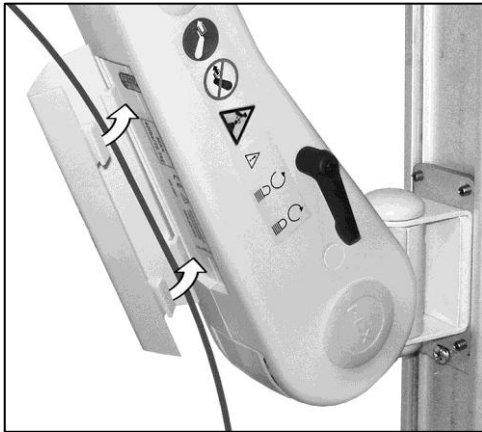

Installing the 16" Wall Channel Cover

Install the Wall Channel Cover in accordance with the *Channel Cover Installation Guide (DU-UT-0001-20)*.

VHM Arm Operation & Adjustment

Swiveling the Mounted Instrument and Adjusting Swivel Tension

1. To swivel mounted instrument, simply push or pull instrument.
2. To adjust swivel tension, tighten or loosen the Swivel Tension Nut using the 1/2" [13 mm] socket wrench provided.

Installation Note: It may be necessary to remove an existing down post from the swivel cup to gain access to the Swivel Tension Nut.

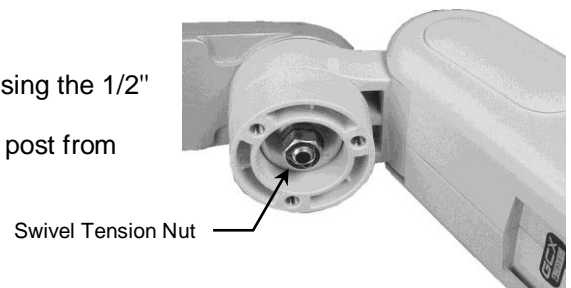

Tilting the Mounted Instrument and Adjusting Tilt Tension

1. To tilt the instrument, grasp the top and bottom of the instrument and tilt it to the desired angle.
2. To adjust tilt tension, equally tighten or loosen the two (2) Tilt Tension screws using the 5/32" hex wrench provided.

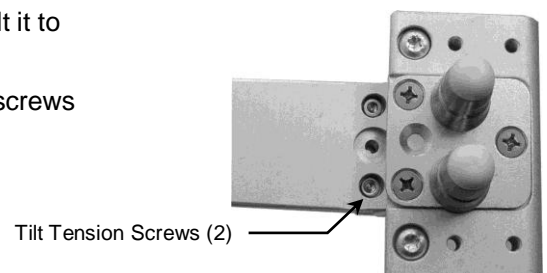

Pivoting the Arm and Adjusting Pivot Tension

1. To pivot Arm at Channel, simply push on side of Arm.
2. To adjust pivot tension, remove top and bottom plastic bolt caps from Pivot Bolt. Using the 1/2" [13mm] socket wrench provided and a 1/2" [13mm] box or open-end wrench, tighten or loosen Pivot Bolt and Hex Nut to desired tension. Reinstall bolt caps back over each end of Pivot Bolt.

1/2" [13 mm] Box-end Wrench

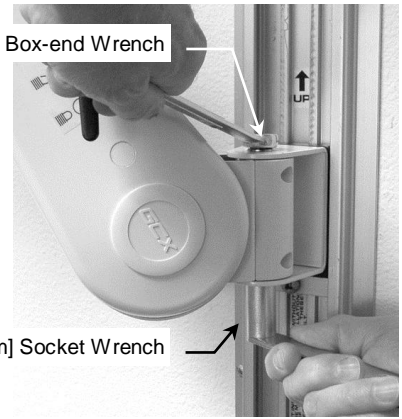

1/2" [13 mm] Socket Wrench

Adjusting Height of the Mounted Instrument



WARNING

- Do not attempt to adjust height without instrument being mounted on Arm.
 - Use caution when disengaging the Height Locking Lever. The total mounted load may have changed due to the addition or removal of equipment (other than primary instrument) while the Height Locking Lever was engaged. A change in the total load can cause a sudden downward or upward movement of the Arm when the Height Locking Lever is disengaged.
1. Grasp mounted instrument on sides (or handle) and move to desired height. When Arm is counterbalanced correctly (page 4), it will maintain position when adjusted to a new height. **Note:** Disengagement/re-engagement of the Height Locking Lever may be necessary during vertical adjustment of mounted instrument (see **WARNING** above). Engagement of the Height Locking Lever is not required during normal operation of the counterbalanced instrument.

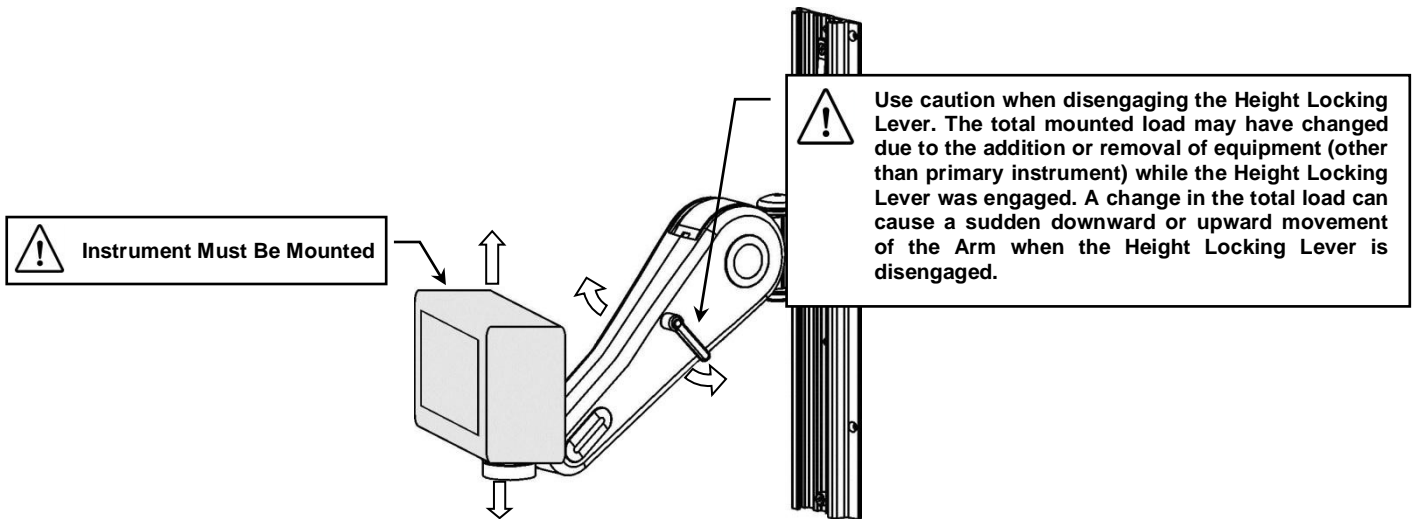

Positioning VHM Arm in Channel

1. Lock the Arm position using the Height Locking Lever.
2. Using the 1/8" hex wrench provided, loosen four (4) set screws in Slide.
3. Relieve the weight of the mounted instrument by lifting against the underside of the Arm, near the instrument. Simultaneously, push up or pull down the opposite end of the Arm immediately in front of the Slide.
4. Tighten four (4) set screws.



Routine Maintenance

Periodically inspect all tilting, swiveling, pivoting, and mounting hardware. Tighten as necessary for optimal operation and safety.

Cleaning the Mounting Assembly

1. The mounting assembly may be cleaned with most mild, non-abrasive solutions commonly used in the hospital environment (e.g. diluted bleach, ammonia, or alcohol solutions).
2. The surface finish will be permanently damaged by strong chemicals and solvents such as acetone and trichloroethylene.
3. Do not use steel wool or other abrasive material to clean the mounting assembly.
4. Damage caused by the use of unapproved substances or processes will not be covered by warranty. We recommend testing of any cleaning solution on a small area of the arm that is not visible to verify compatibility.
5. Do not submerge or allow liquids to enter the arm. Wipe any cleaning agents off of the arm immediately using a water-dampened cloth. Dry the arm thoroughly after cleaning.

CAUTION: GCX makes no claims regarding the efficacy of the listed chemicals or processes as a means for controlling infection. Consult your hospital's infection control officer or epidemiologist. To clean or sterilize mounted instruments or accessory equipment, refer to the specific instructions delivered with those products.